

Keeping your line

up and running

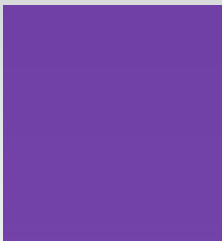

BELT CONVEYOR PRODUCTS

A comprehensive line of innovative belt conveyor products that address the key issues you face.



Partners in Productivity

SOLUTIONS FOR EVERY ISSUE ALONG THE BELT LINE

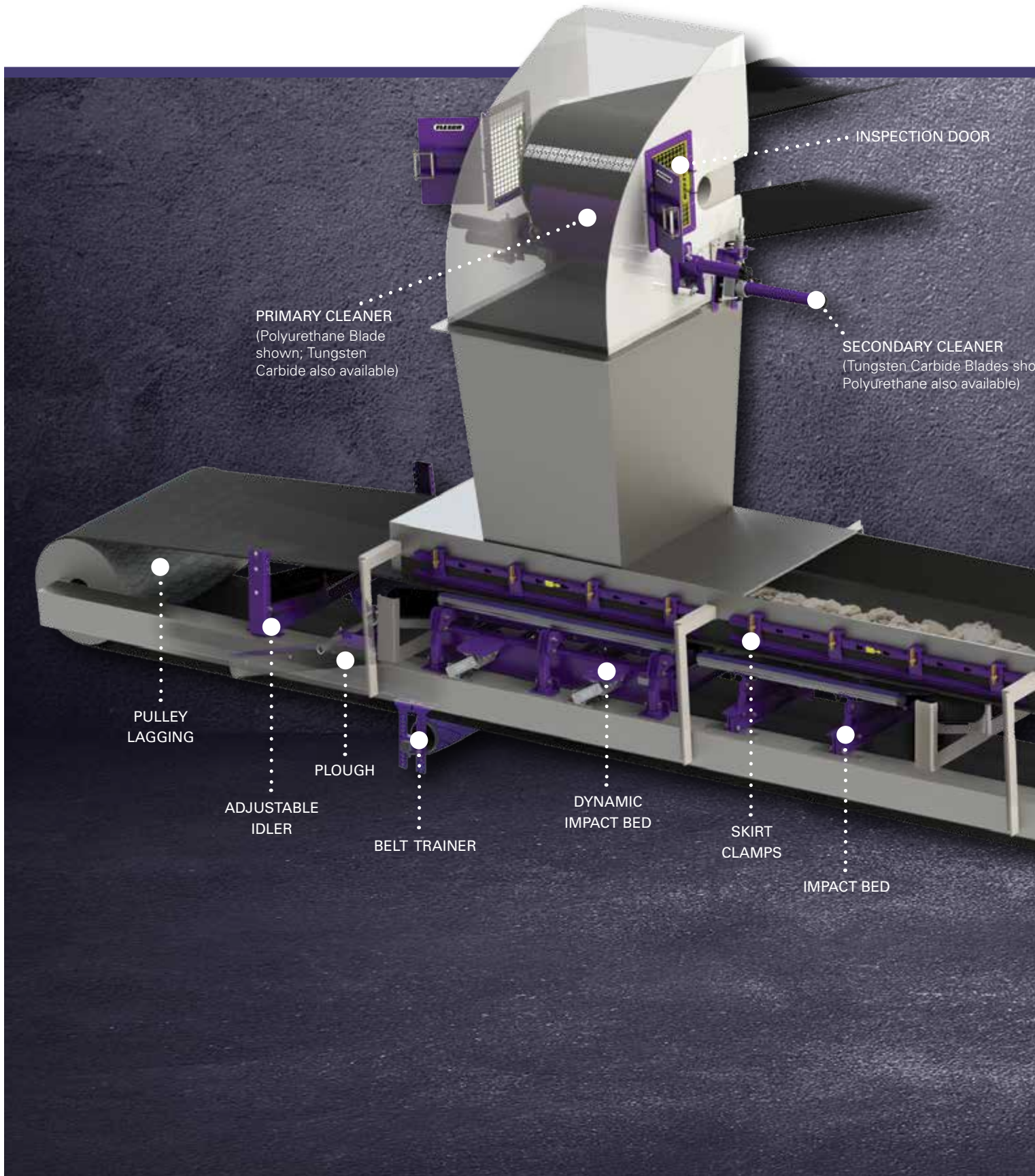

With over 100 years of experience in the belt conveyor industry, Flexco knows that keeping your line running smoothly is essential to the success of your operation. That's why we've developed a comprehensive line of innovative belt conveyor products that address the key issues you face.

Carryback

Material that sticks to the belt after it leaves the transfer point and continues falling off along the conveyor's return side. To address carryback, we offer:

- Belt Cleaners
- Belt Ploughs
- Cleaner Blades

Belt Slip

Occurs when the drive pulley is not adequately gripping the belt due to a loss of friction. To combat slippage, we offer:

- Ceramic Pulley Lagging
- Rubber Pulley Lagging

Mistracking

Belt drifts to one side or the other, resulting in material spillage, uneven belt wear, and possible system damage. To inhibit mistracking, we offer:

- Belt Trainers
- Belt Positioners

Spillage

Material that spills off the belt, typically at transfer and load points. To curb spillage, we offer:

- Skirt Clamps
- Impact Beds
- Belt Ploughs
- Urethane Skirting

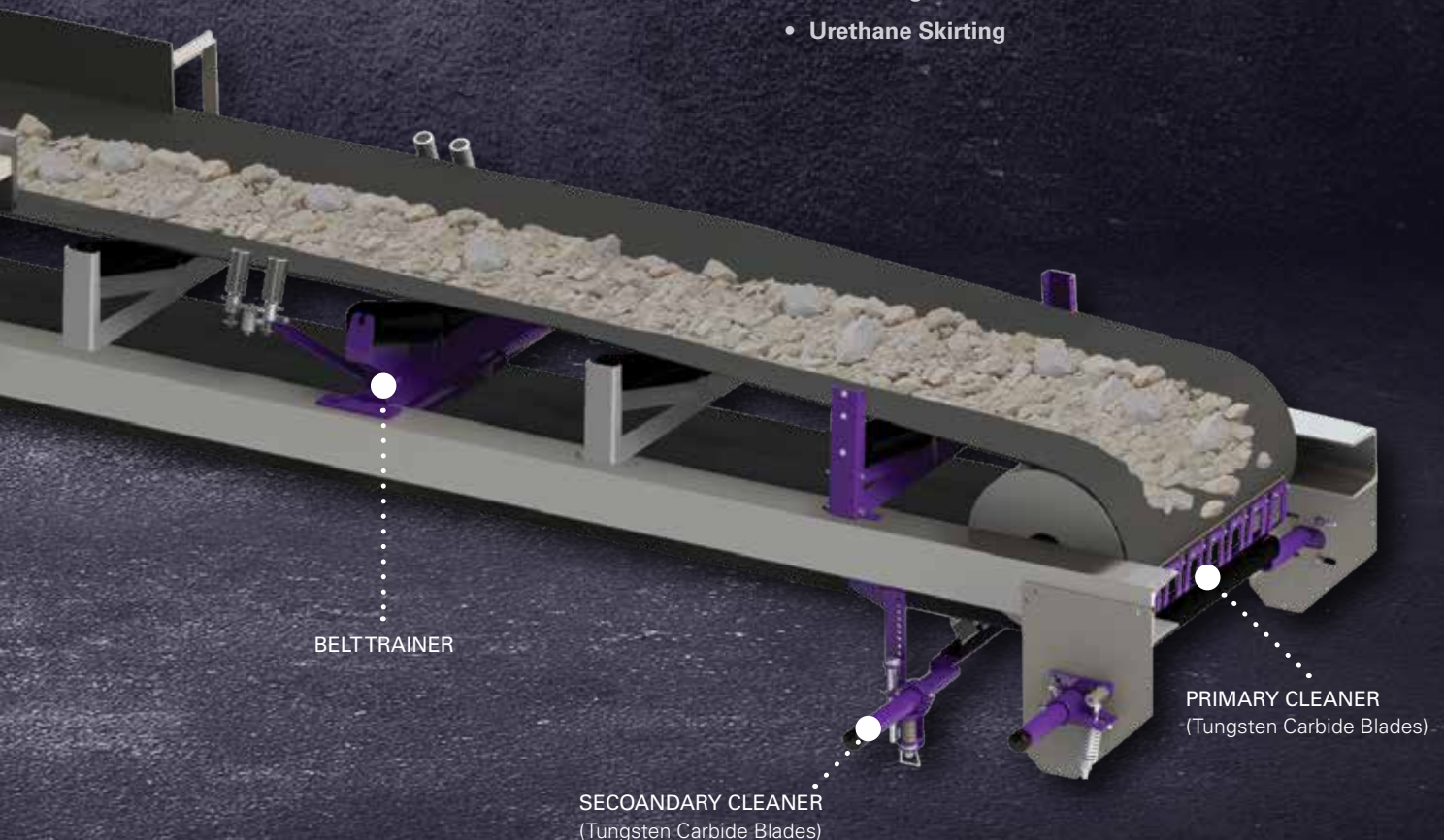



Innovative Designs, Superior Engineering, Industry Expertise

Since 1907, we've been dedicated to improving belt performance and productivity. That's meant spending a lot of time in the field, working alongside customers and learning about their everyday challenges—first-hand.

We use that hard-won knowledge to design belt conveyor products that work better and last longer. In fact, we pioneered many of the advanced features that have since become industry standards.



Cleaner Innovations

- Enhanced Service Advantage Cartridges- offers superior cleaning and serviceability. The cartridge can be easily removed and replaced, even in the dirtiest conditions.
- Better-Performing Tungsten Carbide Cleaner Blades that are made in Australia—After years of testing and research, we've created blades in a variety of sizes, up to 25mm in tip length that last longer and wear more evenly
- Heavy-Duty Tensioning Systems—An important part of our cleaning systems, our tensioners enable easy visual inspection and maintain proper tension
- "Material Path" Cleaning—This unique option lets you match your cleaner width to your actual material path, reducing differential blade wear
- Custom Cleaners—Our poles and cleaners can be custom designed to suit the requirements of your specific application by our in-house engineering team
- Universal Lightweight Poles—Flexco took the standard pole and reduced the safety risk by making it lighter. The additional benefit is the universal face plate which suits most Flexco cleaners, meaning you can be better prepared for unexpected shut downs.



Belt Tracking Innovations

- Pivot-and-Tilt technology—Special sensors detect belt wander, then guide the belt back to the correct path



Impact Bed Innovations

- Velocity Reduction Technology™ —An exclusive feature of our impact beds, this technology deadens impact energy for less rebound and material degradation
- Slide-Out Service™ —Designed for fast and safe complete bar change-outs



Lagging Innovations

- An 80%-Ceramic Solution—We were the first to market with this option
- Certified Australian Made—meaning that we can customise lagging orders within a week to be shipped out to sites around Australia





Mineline® – When “standard” products just won’t do.

Flexco Mineline® products have been designed and engineered to work—day in and day out—in some of the toughest applications in the world. Regardless of the application, whether it be iron ore mining, underground coal mining, port loading facilities, or other heavy tonnage applications that test the strength and durability of your conveyor system, Mineline is the answer. Customers have come to expect a Flexco cleaner, impact bed or tracker with the Mineline brand by its name to excel—even in situations where other products have failed. Next to Mineline endorsed products, you’ll find this mark:



Flexco Belt Conveyor Products Deliver Benefits for Your Belt—And Your Bottom Line

Budget Savings

- Flexco cleaners and other belt conveyor products increase the life of the belt by reducing wear from carryback, mistracking, and other issues. Given the cost of belting, being able to keep your belts longer can mean substantial savings.
- Our products also help reduce wear on other key conveyor components, like rollers, pulleys, splices, and more. That saves you even more money.
- By cutting down on carryback, spillage, and other belt problems, our products also reduce safety hazards. So you can ensure your crew gets home safely.

Lower Maintenance Costs

- Because they reduce carryback and spillage, our belt conveyor products cut down on time-consuming cleanup.
- When your belt and other important conveyor components are protected from damage, you can spend less time making repairs and less money buying replacement components. In fact, studies show that reducing carryback from 3 percent to 1 percent can result in a 67 percent reduction in maintenance costs.

Consistent, Efficient Performance

- Unscheduled shutdowns for maintenance or repairs mean serious production losses. Our belt conveyor products help you maximise uptime by correcting the issues—such as mistracking and carryback—that typically cause system damage.

Greater Safety

- Studies show that approximately 42 percent of conveyor-related accidents occur during maintenance activities. Our cleaners and other belt conveyor products minimise the need for maintenance and reduce the risk of accidents.
- We focus on researching and developing the finest safety tools for mine sites such as our Flex-Lifter™, Electric Belt Cutter, and Lightweight Pole

Serviceability

- Proper servicing of products, such as belt cleaners and impact beds, is key to ensuring effective and long-lasting performance. That’s why all Flexco products are designed with features that make regular servicing easy.
- We are continually enhancing our already service-friendly products, making them even easier to maintain. For example, we’ve added an easy-to-replace blade cartridge to our MHS Heavy-Duty Secondary Cleaner, and Slide-Out Service™ bars to our DRX™ Impact Beds.

YOUR ISSUE: CARRYBACK OUR SOLUTION: ADVANCED CLEANING SYSTEMS

Step 1 Understand Your Options

BELT CLEANERS

Primary Cleaners

- Mounted to the head pulley and below the material flow
- Ideal for removing large pieces of material – Flexco cleaners will ensure that the majority of carryback is removed by the primary cleaner

Secondary cleaners

- Located just past where the belt leaves the head pulley—and anywhere else down the beltline
- Especially good at removing fines

BLADE OPTIONS

Tungsten carbide:

- Superior cleaning efficiency
- Long wear
- Available in Extra-Life and Extra Extra Life Sizes for Iron Ore Applications

Polyurethane

- Easier on the belt
- Works well with mechanical splices
- Specialty formulations for high heat, chemical resistance, or water removal



Step 2 10 Key Criteria for Analysing Your Conveyor System

- 1 Your belt speed and belt width*
- 2 What types of splices are present and their condition*
- 3 Any unusual characteristics of your load or environment (extreme heat, abrasiveness, mud, etc.)—a specialty cleaner that can withstand these conditions may be necessary*
- 4 Whether the belt reverses
- 5 Your conveyor structure width
- 6 Your pulley diameter—typically, the larger the pulley, the larger the required cleaner
- 7 Your pulley condition—if the pulley is worn or not perfectly round, a segmented blade may clean more effectively
- 8 Where you plan to position the cleaner and how much room there is to accommodate it
- 9 The material's path on the belt—matching the cleaner to the material path reduces differential blade wear
- 10 Your desired level of performance and upkeep

Step 3 Determine Whether You Need a Complete Solution

Some operators want their belts as clean as possible; others are comfortable with a certain amount of renegade material.

To achieve maximum cleaning efficiency, it's best to bring together a primary cleaner and one or more

secondary cleaners to form a comprehensive system. If you only want to install a single cleaner, try to target the area—such as the head pulley—where it will have the greatest effect.



APPLICATION CLASSIFICATION GUIDE



CEMA (Conveyor Equipment Manufacturers Association) publishes a guide with the explicit goal of providing "a uniform method for determining the application class of any individual belt cleaner." This is meant as a way to assist in the selection of the correct belt cleaner or belt cleaner system. The complete guide, titled "**Classification of Applications for Bulk Material Conveyor Belt Cleaning,**" or CEMA Standard 576, is available from CEMA.

The classification is built on a points system based on five key criteria. While others play a role as noted on Page 6, these five were chosen as the key elements in selecting the appropriate cleaner or cleaning system. The five criteria are:

1. **belt width**
2. **belt speed**
3. **splice type**
4. **material abrasiveness**
5. **material stickiness/moisture content**

Each of these criteria score points; points increase based on the impact it would have on the required cleaner. Wider belt widths, faster belt speeds, introduction of mechanical splices, increase in material abrasiveness (using CEMA Standard 550), and increasing the moisture content of the material all add to the point totals when scoring an application.

The results of scoring the application created five classes:

Score	Class
<6	1
7-10	2
11-15	3
16-23	4
>24	5

In accordance with this classification, you will find class ratings for Flexco's belt cleaners throughout this guide as another resource to assist you in choosing the correct cleaning system for your application, while keeping in mind the full criteria found on Page 6. For more detailed info on each cleaner, log on to www.flexco.com.au.

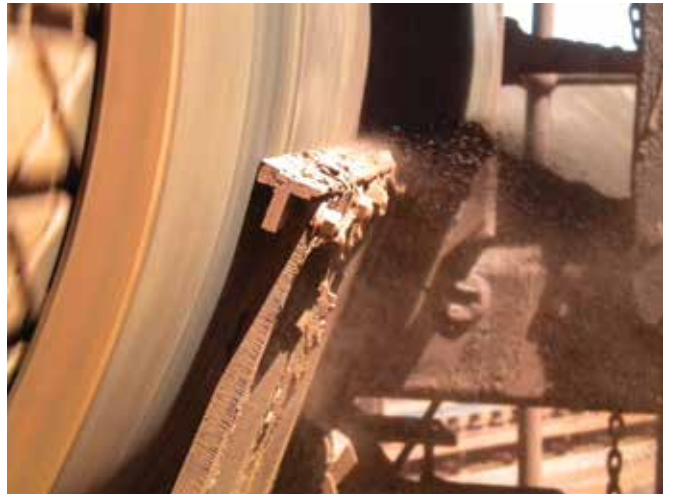

Shown: H-Type V-Tip Primary Cleaner



Shown: MDWS Secondary Cleaner, FMS Tertiary cleaner



Shown: MDWS Secondary Cleaner

BLADE AND CLEANER OPTIONS



Primary Cleaner Options

Application Description	EZP-LS	EZP1 (Std/White)	EZP1 High Temp	EZP1 UHT	H-Type® (XF8 & XF)	H-Type® (HV & HV2)	High Temp V-Tip
Belt Width*	300–1500mm	450–1800mm	450–1800mm	300–1800mm	450–2400mm	450–3000mm	450–1200mm
Belt Speed**	< 2.5 m/s	< 3.5 m/s	< 3.5 m/s	< 3.5 m/s	< 5.0 m/s	< 7.5 m/s	< 5.0 m/s
Head Pulley Diameter	150–550mm	250–900mm	250–900mm	250–900mm	250–1175mm	250–1675mm	200–875mm
Temperature Range	-35 to 82°C	-35 to 82°C	< 135°C with spikes to 163°C	< 200°C with spikes to 232°C	-35 to 82°C	-35 to 82°C	< 200°C with spikes to 232°C
Blade	ConShear LS	ConShear	ConShear	ConShear	HXF, HXF2	HV	HV
Reversing Belts	Yes	Yes	Yes	Yes	Yes	Yes	Yes
Mechanical Fasteners	Yes	Yes	Yes	Yes	Yes	No	No

*Special sizes available upon request.

**Belt speeds can be higher in vulcanized applications.



Secondary Cleaner Options

Application Description	Y-Type SD Polyurethane	Y-Type HD Polyurethane	Y-Type UHT Polyurethane	Y-Type SD Carbide	Y-Type HD Carbide	P-Type (V-Tip)	R-Type (V-Tip)	FMS (C-Tip)	FMS (V-Tip)
Belt Width*	450 – 1200 mm	900 – 1800 mm	900 – 1800 mm	450 – 1200 mm	900 – 1800 mm	450 – 1800 mm	450 – 1800 mm	600 – 1800 mm	450 – 2100 mm
Belt Speed**	<3.0 m/s	<3.8 m/s	<3.8 m/s	<3.0 m/s	<3.8 m/s	<6.0 m/s	<6.0 m/s	<5.0 m/s	<6.0 m/s
Temperature Range	-35 to 82°C	-35 to 82°C	up to 200°C with spikes to 232°C	-35 to 82°C	-35 to 82°C	-35 to 82°C	-35 to 82°C	-35 to 82°C	-35 to 82°C
Reversing Belts	Yes	Yes	Yes	Yes	Yes	No	Yes	No	No
Work with Mechanical Fasteners	Yes	Yes	Yes	Yes	Yes	No	No	Yes	No

Application Description	MHS (C-Tip)	MHS (V-Tip)	U-Type® (F-Blade)	U-Type (V-Blade)	MDWS	Chevron	Motorised Brush Cleaner	CBS
Belt Width*	600 – 2400mm	600 – 2400mm	450 – 3000 mm	450 – 2500 mm	450 – 3200mm	450 – 1500 mm	450 – 2100 mm	450 – 2100 mm
Belt Speed**	<6.0 m/s	<7.5 m/s	<7.5m/s	<7.5m/s	<5.0 m/s	<2.5 m/s	<3.5 m/s	<4.0 m/s
Temperature Range	-35 to 82°C	-35 to 82°C	-35 to 82°C	-35 to 82°C	-35 to 82°C	-35 to 82°C	-30 to 82°C	-30 to 82°C
Reversing Belts	Yes	Yes	No	No	No	Yes	No	No
Work with Mechanical Fasteners	Yes	No	Yes	No	Yes	Yes	Yes	Yes

*Special sizes available upon request.

**Belt speeds can be higher in vulcanized applications.

All cleaners available in Stainless Steel Available in either 60 or 73mm pole diameters



FLEXCO PRIMARY CLEANERS

FEATURES & APPLICATIONS

EZP-LS "Limited Space" Primary Cleaners

- Compact design with shorter pole length
- Do-it-yourself installation and minimal maintenance
- Standard-duty, solid-blade design
- Visual tension check
- Available in stainless steel

EZP-LS Standard



Specifications:

Maximum Belt Speed*: 2.5 m/s

Pulley Diameter: 150–550 mm

Applications: Brick/Block Plants, Ready Mix Plants, Road/Mobile Equipment



EZP-LS High-Temp



- High-Temp Blade rated up to 135° C
- Can handle temperature spikes to 163° C
- Applications: Coke, Clinker, Cement, Asphalt

EZP-LS Stainless Steel Food Grade



- White food-grade, chemical-resistant ConShear™ blade
- Stainless Steel components for superior corrosion resistance
- Applications: Fermentation Byproducts, Preprocessed Foods

EZP1 Primary Cleaners

- Standard-duty, with 60 mmdiameter pole
- Requires just 100 mm of horizontal clearance
- Do-it-yourself installation and minimal maintenance
- Visual tension check
- Available in stainless steel

EZP1 Standard



Specifications:

Maximum Belt Speed*: 3.5 m/s

Pulley Diameter: 250–900 mm

Applications: Aggregate, Sand & Gravel, Cement, Wood Processing, Recycling



EZP1 High-Temp



- High-Temp Blade rated up to 135° C
- Can handle temperature spikes to 163° C
- Applications: Coke, Clinker, Cement, Asphalt

EZP1 Ultra High-Temp



- High-Temp Blade rated up to 200° C
- Can handle temperature spikes to 232° C
- Applications: Coke, Clinker, Cement, Asphalt

EZP1 Stainless Steel Food Grade



- White food-grade, chemical-resistant ConShear™ blade
- Stainless Steel components for superior corrosion resistance
- Applications: Fermentation Byproducts, Preprocessed Foods

EZP1 Twist Tensioner



- Compact Torsion Twist Tensioner allows for measurable and verifiable tension
- Tensioner compatible to mount on either end of pole

*Belt speeds can be higher in vulcanized applications.

Cleaner Key:



HV2 Primary Cleaner

- Tungsten carbide tip provides superior cleaning efficiency (vulcanized belts only)
- 150 mm segmented blades work independently
- Adjustable cushions allow for enhanced pulley conformance
- Visual tension check
- Available in stainless steel



Specifications:

Maximum Belt Speed: 7.5 m/s

Pulley Diameter: 250–1675 mm

Applications: Power Plants, Port Facilities, Hard Rock Mining, Steel Mills, Iron Ore



H-Type® HV/HVP Primary Cleaner

- Tungsten carbide tip provides superior cleaning efficiency (vulcanized belts only)
- Segmented blades work independently
- Visual tension check
- Available in stainless steel
- Also available: H-Type® Enhanced Service Advantage Cartridge HD Primary Belt Single and Dual Cleaners



Specifications:

Maximum Belt Speed*: 7.5 m/s

Pulley Diameter: 250–1575 mm

Applications: Power Plants, Port Facilities, Hard Rock Mining, Steel Mills, Iron Ore



Optional HV Protected Tips

H-Type® High-Temp HV Primary Cleaner

- Tungsten carbide tip provides superior cleaning efficiency (vulcanized belts only)
- Segmented blades work independently
- Adjustable cushions allow for enhanced pulley conformance
- Visual tension check
- Available in stainless steel



Specifications:

Maximum Belt Speed*: 5.0 m/s

Pulley Diameter: 250–1575 mm

Applications: Power Plants, Port Facilities, Steel Mills, Iron Ore



H-Type® HXF8 Primary Cleaner

- Suitable as a stand-alone cleaner in standard and heavy-duty applications
- Features Polyurethane Tips
- Available in stainless steel



Specifications:

Maximum Belt Speed*: 5.0 m/s

Pulley Diameter: 250–1325 mm

Applications: Underground Mining, Hard Rock Mining, Metal Mining, Aggregate



*Belt speeds can be higher in vulcanized applications.

Applications listed are intended to identify where each cleaner is commonly and most effectively utilised.

Belt conditions, belt speeds, and pulley diameters should all be considered before making a final product selection.

Consult Flexco to assess specific applications and recommendations.

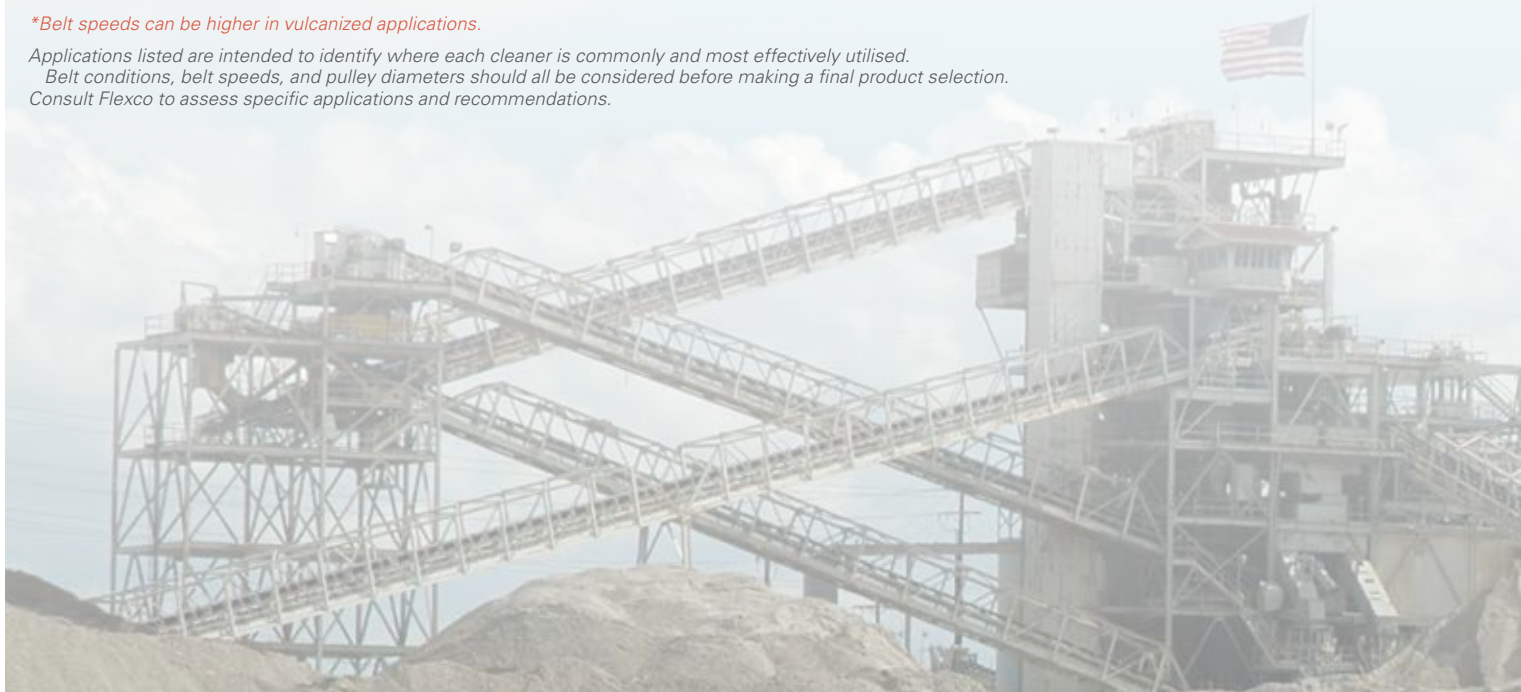

FLEXCO TENSION OPTIONS

Spring Tension

A simple solution. Easy to measure, maintains blade-to-belt contact for longer periods between services.

Advantages:

- By using Flexco reference guides, your crew will be able to take the guesswork out of setting correct tension levels
- Superior cleaning efficiency: using a spring allows flexibility in the tension, producing constant blade-to-belt tension. This leads to significant reductions in carryback and downtime, as well as an increase in cleaning efficiency
- Reduced labour: More efficient maintenance – no need to constantly guess whether someone has already tightened the tension or unnecessary re-tensioning the spring. Simply measure and adjust as needed until your next scheduled maintenance check
- Ability to check tension quickly and safely using a ruler

Bolt Tension

A low-cost solution for experienced cleaner technicians; requires regular maintenance.

Advantages:

- The most cost-effective solution available
- As bolt tensions are completely manual, the user has full control – a perfect option for someone who has the ability to check the cleaner every few days
- Perfect for experienced cleaner technicians who are able to judge cleaner effectiveness based on a visual inspection

Air Tension

Best for isolated areas such as shuttles, this type of side assembly will maintain tension on its own and does not need to be checked regularly.

Advantages:

- The most low-maintenance option available
- No need to record tension lengths or perform visual inspections – this tension option will automatically adjust to an optimum blade-to-belt tension
- Once installed, this tension option requires minimal maintenance





FLEXCO SECONDARY CLEANERS

FEATURES & APPLICATIONS

Y-Type Secondary Cleaner—Polyurethane

- Standard duty (belt widths 450-1200mm)
- Segmented tips easily serviced utilising a removable cartridge
- Spring tensioned to deliver optimal cleaning performance and blade life
- Food grade/chemical resistant polyurethane option available
- Compatible with reversing belts

Y-Type SD Purple Blade

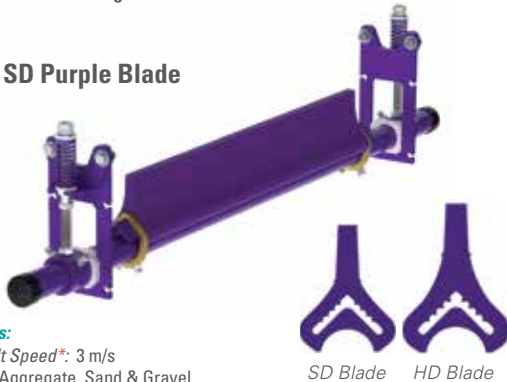

Specifications:

Maximum Belt Speed*: 3 m/s
 Applications: Aggregate, Sand & Gravel, Cement



SD Blade HD Blade

Y-Type SD White Blade



- Standard duty (belt widths 450-1200mm)
- Maximum belt speed: 3 m/s
- Applications: Preprocessed Foods



Y-Type HD Purple Blade



- Heavy duty (belt widths 900-1800mm)
- Maximum belt speed: 3.75 m/s
- Applications: Aggregate, Sand & Gravel, Cement



Y-Type HD White Blade

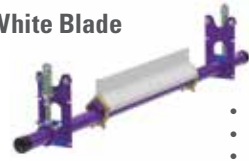

- Heavy duty (belt widths 900-1800mm)
- Maximum belt speed: 3.75 m/s
- Applications: Preprocessed Foods



Y-Type SD Red Blade



- Standard duty (belt widths 450-1200mm)
- Maximum belt speed: 3 m/s
- Applications: Coke, Clinker, Cement, Asphalt



Y-Type HD Red Blade

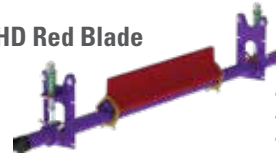

- Heavy duty (belt widths 900-1800mm)
- Maximum belt speed: 3.75 m/s
- Applications: Coke, Clinker, Cement, Asphalt



Y-Type HD Tungsten Carbide Blade



- Heavy duty (belt widths 900-1800mm)
- Maximum belt speed: 3.75 m/s
- Applications: Aggregate, Sand & Gravel, Cement, Mining



Y-Type Secondary Cleaner—Tungsten Carbide

- Standard duty (belt widths 450-1200mm)
- Segmented tungsten carbide blades compatible with mechanical fastener applications are easily serviced utilising a removable cartridge
- Spring tensioned to deliver optimal cleaning performance and blade life
- Compatible with reversing belts

Y-Type SD Tungsten Carbide Blade



Specifications:

Maximum Belt Speed*: 3 m/s
 Applications: Aggregate, Sand & Gravel, Cement, Light Mining



SD Blade HD Blade

*Belt speeds can be higher in vulcanized applications.

P-Type® Secondary Cleaner

- Available with C-Tips for mechanical fastener applications or V-Tips for vulcanized applications
- Segmented tungsten carbide blades
- Limited Space model option for telescoping, stacking, or portable conveyors
- Bolt-up tensioning system
- Available with HD cushions

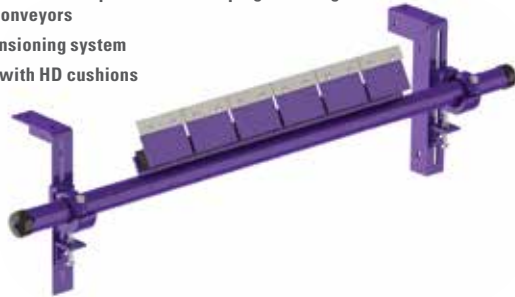

Specifications:

Maximum Belt Speed*: C-Tip: 5.0 m/s
V-Tip: 6.0 m/s

Applications: Aggregate, Sand & Gravel, Cement, Wood Processing, Light Mining, Power Plants with Vulcanized Belts



P-Type® Cartridge Secondary Cleaner

- Available with C-Tips for mechanical fastener applications or V-Tips for vulcanized applications
- Service Advantage Cartridge feature allows for easy service and inspection
- Bolt-up tensioning system
- Available with HD cushions



Specifications:

Maximum Belt Speed*: C-Tip: 5.0 m/s
V-Tip: 6.0 m/s

Applications: Aggregate, Sand & Gravel, Cement, Wood Processing, Light Mining, Power Plants with Vulcanized Belts



R-Type® Reversing Secondary Cleaner

- Available with C-Tips for mechanical fastener applications or V-Tips for vulcanized applications
- Two-way cushions that accommodate reversing belts
- Do-it-yourself installation
- Bolt-up tensioning system



Specifications:

Maximum Belt Speed*: C-Tip: 5.0 m/s
V-Tip: 6.0 m/s

Applications: Aggregate, Sand & Gravel, Cement, Wood Processing, Light Mining, Recycling, Power Plants with Vulcanized Belts



R-Type® Cartridge Secondary Cleaner

- Available with C-Tips for mechanical fastener applications or V-Tips for vulcanized applications
- Two-way cushions that accommodate reversing belts
- Service Advantage Cartridge feature allows for easy service and inspection
- Bolt-up tensioning system



Specifications:

Maximum Belt Speed*: C-Tip: 5.0 m/s
V-Tip: 6.0 m/s

Applications: Aggregate, Sand & Gravel, Cement, Wood Processing, Light Mining, Ideal for Power Plants with Vulcanized Belts



FMS Heavy-Duty Secondary

- Available with C-Tips for mechanical fastener applications or V-Tips for vulcanized applications
- Cleaning efficiency of segmented tungsten carbide blades
- Compact MST spring tensioning system



Specifications:

Maximum Belt Speed*: C-Tip: 5.0 m/s
V-Tip: 6.0 m/s

Applications: Underground Mining, Hard Rock Mining, Metal Mining, Aggregate, Load-out Facilities, Iron Ore, Steel Mills, Power Plants



Universal Lightweight Pole

- The lightest cleaner pole on the market, engineered with safe lifting in mind
- Compatible with Flexco H-Type®, FMS, MHS & P-Type® Cleaners.
- 40-60% lighter than steel



Universal Plate

*Belt speeds can be higher in vulcanized applications.

Cleaner Key:



MHS Heavy-Duty Cleaners

- Segmented blades with choices of tungsten carbide tips
- Patented PowerFlex™ cushions maintain optimal belt contact
- Tensioners and cushion create 4 points of relief, making the cleaner fastener-friendly
- Available in stainless steel

MHS Heavy-Duty Secondary

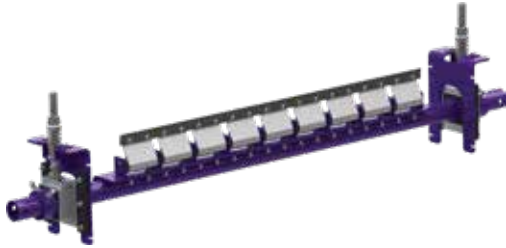

- Optional two-way cushions available for reversing applications that roll back, or tripper and stacker applications



Optional MST Tensioner (reduces belt speed max)



Optional SAT XD Tensioner

MHS Stainless Steel Secondary



- Stainless Steel components for superior corrosion resistance
- Applications: Salt, Copper/Gold Mining, Phosphate, Potash, Load-out Facilities

MHS Heavy-Duty Cartridge Secondary



- Service Advantage Cartridge™ feature allows for easy service and inspection

Specifications:

Maximum Belt Speed*: C-Tip: 6.0 m/s
V-Tip: 7.5 m/s

Applications: Underground Mining, Hard Rock Mining, Metal Mining, Aggregate, Load-out Facilities, Iron Ore, Steel Mills, Power Plants

Continuous Blade Secondary

- The thin, hard edge of the metal blade delivers high cleaning efficiency and long wear life.
- When the CBS is teamed with the MMP pre-cleaner the system provides maximum cleaning power for tough applications.
- Made from heavy-duty, corrosion-resistant steel, the CBS is available in sizes for belt widths from 450 to 2400mm (18" to 96"). Additional sizes are available upon request.
- All service can be performed from a safe position at the side of the conveyor.



Optional SAT XD Air/Water Tensioner

Specifications:

Maximum Belt Speed*: 4.0 m/s

Applications: Underground Mining, Hard Rock Mining, Metal Mining, Aggregate, Load-out Facilities, Iron Ore, Steel Mills, Power Plants

CEMA Class 4

Applications listed are intended to identify where each cleaner is commonly and most effectively utilised.

Belt conditions, belt speeds, and pulley diameters should all be considered before making a final product selection. Consult Flexco to assess specific applications and recommendations.

U-Type® Secondary

- U-shaped blade and offset pole that intensify cleaning power
- Blade tips that scrape off stubborn carryback, while rubber backers "squeeze" wet material
- Best for cupped belts and belts with worn centres
- Choice of tungsten carbide, impact-resistant tungsten carbide, or polyurethane blade tips
- Blade replacement made easy with removable front plate
- Works best in wet applications
- Available in stainless steel



U-Type® Stainless Steel Secondary



Specifications:

Maximum Belt Speed*: C-Tip: 6.6 m/s

Applications: Cement, Coal Mining, Coal Prep Plants, Power Plants, Load-out Facilities



- Stainless Steel components for superior corrosion resistance

- Applications: Power Plants, Load-out Facilities

14 Cleaner Key:



WET



STICKY



DRY



HIGH TEMPERATURE



CORROSIVE



FRAS

Chevron Secondary Cleaner

- For raised top, chevron, or grooved belts
- Hundreds of rubber fingers that flick off carryback
- Free-rotating design that works only when the belt runs
- Do-it-yourself installation and quick drum replacement



Specifications:

Maximum Belt Speed*: 2.5 m/s
Applications: Wood Chipping, Sand



Motorised Brush Cleaner

- Uniquely patterned bristles aid in reducing material buildup and clogging
- Adjustable tensioners allow easy brush-to-belt adjustment as the bristles wear
- Spins opposite the belt direction for optimal cleaning
- Do-it-yourself installation and quick drum replacement



Specifications:

Maximum Belt Speed*: 3.5 m/s
Applications: Wood Chipping, Sand



MDWS DryWipe Secondary

- Removes excess water to ensure a dry return trip down the belt line
- Ideal for systems using a water spray pole
- Do-it-yourself installation and minimal maintenance



Specifications:

Maximum Belt Speed*: 5.0 m/s
Applications: Underground Mining



Optional MST
Tensioner

Wash Box

- Fully enclosed to clean belt and then contain the waste wash water
- Configurable cleaner mounting plate accepts all of Flexco's superior secondary belt cleaners
- Hinged doors on each side for easy service and inspection
- Hold-down roller provides proper tension for each cleaner
- Available in galvanised or stainless steel
- Can be custom made
- Suitable for large belt widths



FLEXCO CLEANERS AND FASTENERS: BETTER, TOGETHER

Many of our cleaning systems have special features that allow them to interface seamlessly with our mechanical belt fasteners.

Shown: MHS Secondary Cleaner with Service Advantage Cartridge™

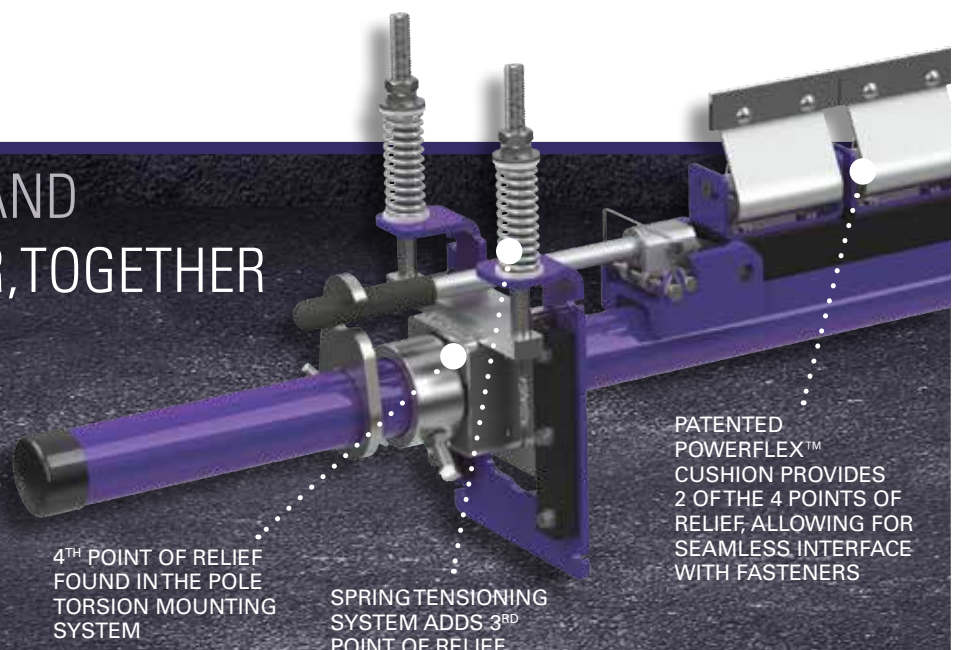

FLEXCO BELT CLEANER ACCESSORIES



Optional Top Angle Kit

- Used with both Standard and Long SST Mounting Bracket Kits (below left) for additional mounting options



MST Mounting Bracket Kit

- For FMS secondary cleaner installs requiring additional mounting versatility



SST Mounting Bracket Kit

- For MHS or MDWS secondary cleaner installs requiring additional mounting versatility
- Long mounting bracket kit also available for installations that require extra length legs



YST Mounting Bracket Kit

- For Y-Type secondary cleaner installs requiring additional mounting versatility

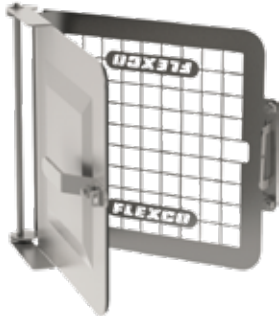

Inspection Door

- Lockable design
- Dust-tight seal
- Available in 300 x 300 mm, 400 x 400mm, 500 x 500 mm, and 600 x 600 mm
- Available with or without screen
- Custom varieties available



Stabilising Rollers

- For use in applications with belt cup or belt flap
- By preventing these issues secondary cleaner performance and blade/tip life is enhanced

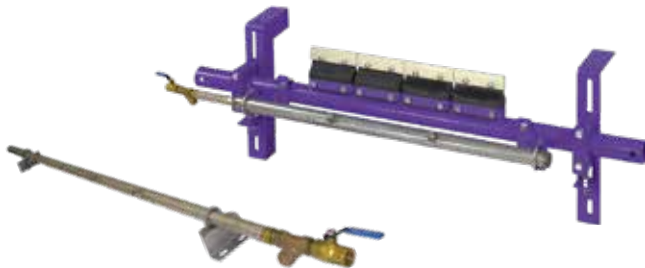

Water Spray Pole Kit

- Stainless steel pole with powder coated steel clamp brackets
- For use with secondary cleaners for an exceptionally clean belt
- Typical pressure setting is 276-414 kPa



Spring Covers and Tensioner Locks (for Primary Cleaners and Secondaries)

- Spring Covers protect spring and threaded rod from contamination and material buildup
- Tensioner Lock prevents unauthorised cleaner retensioning



YOUR ISSUE: BELT MISTRACKING OUR SOLUTION: BELT TRAINERS

To select the right belt trainer, you need to consider whether:

- The belt is wandering to one or both sides
- The top or return side of the belt is affected
- The mistracking is happening consistently or occasionally
- The belt has a low, medium or high running tension

Use the following chart to identify the best Flexco belt trainer for your needs.

Conveyor Criteria	Belt Positioner™	PTEZ™	PT Smart™	PT Max™	PT Max™ Heavy Duty	PT Max™ Super Duty
Top side mistracking	No	No	No	Yes	Yes	Yes
Return side mistracking	Yes	Yes	Yes	Yes	Yes	Yes
Reversing belts	Yes	Yes	No	No	No	No
Belt has edge damage	Best	Best	Good	Good	Good	Good
Ease of installation	Best	Better	Good	Good	Good	Good
Belt has low running tension	Good	Good	Good	Good	N/A	N/A
Belt has medium running tension	Better	Better	Better	Best	Best	Best
Belt has high running tension	N/A	N/A	N/A	Better	Best	Best
Approx. "upstream" effect*	15 M	6 M	6 M	15 M	15 M	15 M
Approx. "downstream" effect*	15 M	30 – 36 M	36 – 45 M	45 – 61 M	45 – 61 M	45 – 61 M

*Typical results; actual results may vary

FLEXCO BELT TRAINERS

FEATURES & APPLICATIONS

Belt Positioner™

- Simple solution for belts wandering to a single side
- Fixed, angled rollers "funnel" the belt onto the correct path
- Return-side installation only
- Easy to install and maintain
- Available with steel or CoreTech® rollers



Specifications:

Maximum Belt Tension: Small, Medium and Large: 157.5 n/mm
Extra-Large: 210 n/mm

Belt Dimensions: From 450–2400 mm wide

PTEZ™

- Tapered roller ends drive “pivot and tilt” mechanism to correct mistracking
- Versatile mounting options. Can be installed on clean side of return belt if belt is cupped
- Polyurethane roller cover to ensure long-lasting performance
- Easy to install on one-way and reversing belts



Specifications:

Maximum Belt Tension: 1600 PIW
Belt Widths: 450-1200 mm (18-48")

PTEZ™ Heavy Duty



- Stainless Steel components for superior corrosion resistance

Specifications:

Maximum Belt Tension: 2400 PIW
Belt Widths: 1050-2100 mm (42-84")

PT Smart™

- Sensor rollers detect wander, then “pivot and tilt” belt into place
- Economical solution for medium-tension belts
- Effectively prevents belt from damaging structure
- Easy to install
- Specially designed to fit underground conveyors



Specifications:

Maximum Belt Tension: 280 n/mm
Belt Widths: 450-1800 mm

PT Max™ Top Side

- Sensor rollers detect wander, then “pivot and tilt” belt into place
- Ideal solution for cupped and high-tension belts
- Performs in wet and dry conditions
- Top-side installation only

Medium-Duty Operations Specifications:

Maximum Belt Tension: 525 n/mm
Belt Widths: 600-1500 mm

Heavy-Duty Operations Specifications:

Maximum Belt Tension: 1750 n/mm
Belt Widths: 1350-3000mm



PT Max™ Return Side

- Sensor rollers detect wander, then “pivot and tilt” belt into place
- Ideal solution for cupped and high-tension belts
- Performs in wet and dry conditions
- Return-side installation only

Medium-Duty Operations Specifications:

Maximum Belt Tension: 525 n/mm
Belt Widths: 600-1500 mm

Heavy-Duty Operations Specifications:

Maximum Belt Tension: 1750 n/mm
Belt Widths: 1350-3000mm



YOUR ISSUE: LOAD-POINT SPILLAGE OUR SOLUTION: IMPACT BEDS, SLIDER BEDS, SKIRTING SYSTEMS, PLOUGHS & MORE

Set Up an Appropriate Transition Distance

- Often compromised to save space, but short transition can lead to premature belt, lagging, and idler wear or failure.
- Using your idlers or Flexco adjustable idlers, follow recommendations based on your trough angle, belt tension and belt carcass construction.

Divert Material to Avoid Damaging Tail Pulley or Belt

- Material trapped between the pulley and belt can cause significant damage to both.
- Use a plough before the tail pulley to remove material from the belt:
Diagonal Plough for one-side discharge
V-Plough for two-side discharge

Protect Belt in Impact Area

- Just like the belt, impact beds see every ounce of every tonne of product. Careful consideration should be made to account for the worst-case impact your system may ever see.
- Find your drop height and maximum material lump weight to select the proper bed. Never pick a bed with a lower impact rating.
- Flexco offers beds for numerous impact ratings:
Up to 25 kg-m : EZSB-I, EZIB-L, MSB, DRX-200
25 to 100 kg-m : EZIB-M, DRX-750
100 to 200 kg-m : MIB, DRX-1500
200 to 400 kg-m : DRX-3000



When it comes to load zones, our impact beds deliver the highest level of material containment and belt protection. They've been specially designed to control acceleration, deaden impact energy, reduce damaging vibrations, and extend belt life.

Seal the Load Zone

- Clamps and skirting provide the final—and very important—assurance against spillage.
- Clamps should be durable yet easy to use when skirting needs adjustment or replacement.

Track Belt in Load-Point

- If belt is mistracking before the load zone it will mistrack through the load zone, causing spillage.
- Prevent mistracking by installing a Belt Positioner, PT Smart™, or PT Max™ before the tail pulley.

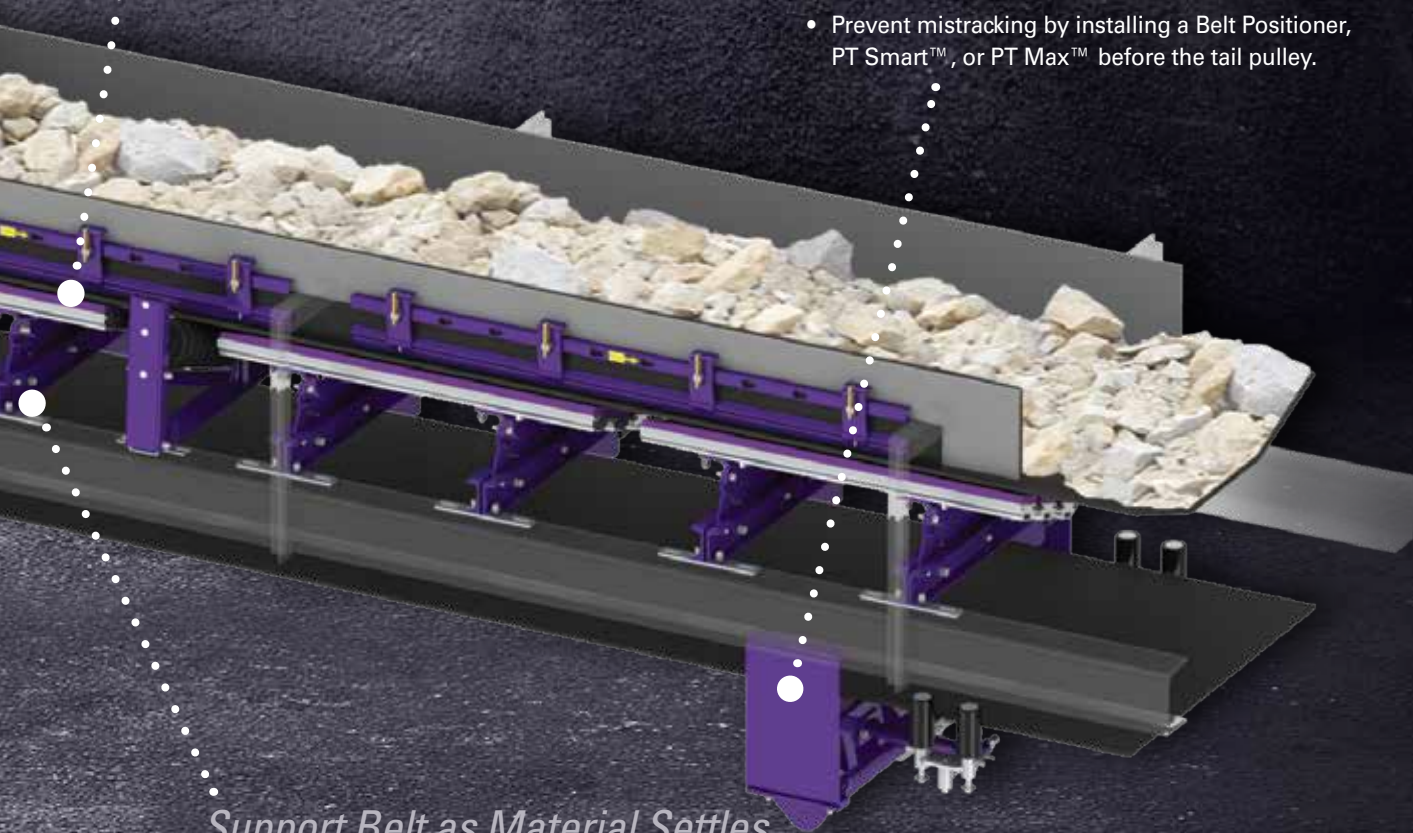

Support Belt as Material Settles

- Most conveyors feature an extended area where material settles after the impact area.
- Idlers often used but sealing with idlers is difficult due to belt sag. Impact beds can be used to help with sealing but are expensive and cause belt drag.
- EZSB-C provides the best of both: idlers in centre to reduce drag, and UHMW bars on trough to provide constant sealing.

How to Select the Right Impact Bed

Step 1:

Calculate Your Impact Energy

Identify the weight of your largest lump size and multiply this number by your drop height. The result, expressed in kg/m (lb/ft), will be your estimated impact energy.

Material Reference Table

Material	kg/m ³
Coke	657
Fertiliser	961
Bauxite, crushed	1281
Potash	1281
Coal, Bituminous, Solid	1345
Coal, Anthracite, Solid	1505
Slag, Solid	2114
Chromium Ore	2162
Halite (Salt), Solid	2322
Phosphorus	2338
Stone (Common, Generic)	2515
Limestone, Solid	2611
Shale, Solid	2675
Granite, Solid	2691
Gypsum, Solid	2787
Trap Rock, Solid	2883
Dolomite, Solid	2899
Malachite (Copper Ore)	3860
Platinum Ore	4293
Hematite (Iron Ore)	5158

Step 2:

Match the Result to the Bed Rating

No Impact: EZSB-C

Up to 25 kg-m: DRX200, MSB, EZSB-I, EZIB-L

25 to 100 kg-m: DRX750, EZIB-M

100 to 200 kg-m: DRX1500, MIB

200 to 400 kg-m: DRX3000

Sample Calculation

Gather data for your Impact Energy Calculation:

Q: What size material are you running?

A: I'm running 200mm minus limestone.

Q: Is that the largest piece you've seen or could a larger piece get through that 200mm crusher setting?

A: Yes, that's the crusher setting; the largest rock I've seen is 200 x 400 x 400mm.

Lump Weight (W)

Limestone Material Density = 2611 kg/m³

Volume = $\frac{200}{1000} \times \frac{400}{1000} \times \frac{400}{1000} = 0.032 \text{ m}^3$

W = 2611 x 0.032 = 83.5 kg

Q: What's the fall height from the top of the feeding conveyor to the receiving belt?

A: There's a 1.5 m drop from the feeding conveyor to a rock box, then another 1.2 m drop to the receiving belt.

Drop Height (H)

H = 1.5 m + 1.2 m = 2.7 m

Impact Energy Calculation:

Lump Weight (W) x Drop Height (H) = Impact Energy

83.5 x 2.7 = 225 kg/m

This impact scenario would require a DRX 3000.

FLEXCO IMPACT BEDS

FEATURES & APPLICATIONS

Flexco Slider Bed (EZSB-C)

- Uses Flexco CoreTech® idlers in centre section
- Features adjustable trough frames for use on 20°, 35° or 45°
- Recommended for non-impact sealing areas
- Available with short lead time



Specifications:

Bed Rating: No impact

Belt Width: 600-1800mm

Maximum Belt Speed: 5.0 m/s

Applications: Sealing of extended load zone

Flexco Slider Impact Bed (EZSB-I)

- Uses Flexco CoreTech® impact idlers in centre section
- Features adjustable trough frames for use on 20°, 35° or 45°
- Recommended for -100 to -150 mm materials
- Available with short lead time



Specifications:

Bed Rating: 25 kg/m

Belt Width: 600-1800mm

Maximum Belt Speed: 5.0 m/s

Applications: Sand and Gravel

Flexco Standard-Duty Impact Bed (EZIB-L)

- Features adjustable trough frames for use on 20°, 35° or 45°
- Recommended for light-impact applications
- Recommended for -100 to -150 mm materials
- Available with short lead time



Specifications:

Bed Rating: Up to 25 kg/m
Belt Width: 600-1800mm
Maximum Belt Speed: 5.0 m/s
Applications: Sand and Gravel

Flexco Medium-Duty Impact Bed (EZIB-M)

- Features adjustable trough frames for use on 20°, 35° or 45°
- For medium-impact applications
- Recommended for -200 to -250 mm materials
- Available with short lead time



Specifications:

Bed Rating: 25-100 kg/m
Belt Width: 600-1800mm
Maximum Belt Speed: 5.0 m/s
Applications: Hard Rock Mining, Limestone Quarrying

DRX200 Impact Bed

- Exclusive Velocity Reduction Technology™ that deadens rebound forces for reduced spillage and material degradation
- Recommended for -100 to -150 mm materials
- Slide-Out Service™ for easy maintenance



Specifications:

Bed Rating: Up to 25 kg/m
Belt Width: 600-1800mm
Maximum Belt Speed: 5.0 m/s
Applications: Sand and Gravel

DRX750 Impact Bed

- Exclusive Velocity Reduction Technology™ that deadens rebound forces for reduced spillage and material degradation
- For medium-impact applications
- Recommended for -200 to -250 mm materials
- Provides a unique second level of impact relief



Specifications:

Bed Rating: 25-100 kg/m
Belt Width: 600-1800mm
Maximum Belt Speed: 5.0 m/s
Applications: Hard Rock Mining, Limestone Quarrying

DRX1500 Impact Bed

- Exclusive Velocity Reduction Technology™ that deadens rebound forces for reduced spillage and material degradation
- For high-impact applications
- Recommended for -300 mm materials
- Isolation Mounts ensure a second level of impact force reduction



Specifications:

Bed Rating: 100-200 kg/m
Belt Width: 600-1800mm
Maximum Belt Speed: 5.0 m/s
Applications: Coal-Fired Power Plants, Coal Prep Plants, Load-out Facilities

DRX3000 Dynamic Impact Bed

- Exclusive Velocity Reduction Technology™ that deadens rebound forces for reduced spillage and material degradation
- For extreme-impact applications requiring the highest energy absorption
- Impact Energy Absorbers disperse an immense amount of impact energy
- Stationary skirt support bar system helps ensure a positive seal with the skirt rubber



Specifications:

Bed Rating: 200 to 400 kg/m
Belt Width: 600-1800mm
Maximum Belt Speed: 5.0 m/s
Applications: Any operation that combines large material size and extreme height

Applications listed are intended to identify where each impact bed is commonly and most effectively utilised. Material size, lump weight and drop height should all be considered before making a final product selection. Consult Flexco to assess specific applications and recommendations.

Modular Slider Bed (MSB)

- All bars feature 25 mm UHMW for long wear life
- All bars are chamfered to work with reversing belts
- Recommended for -100 to -150 mm materials
- Adjustable trough angle 20°, 35°, 45°
- Quick and easy service with slide-out trough and centre section removal



Specifications:

Bed Rating: Up to 25 kg/m

Belt Width: 600-1800mm

Maximum Belt Speed: 5.0 m/s

Applications: Sand and Gravel



- Seamlessly combine slider and impact beds for ultimate performance

Modular Impact Bed (MIB)

- All bars feature 25 mm UHMW for long wear life
- All bars are chamfered to work with reversing belts
- Recommended for -300 mm materials
- Adjustable trough angle 20°, 35°, 45°
- Sectional slide-out service allows for service alongside the conveyor
- Outer slider bar to seal the load zone



Specifications:

Bed Rating: Up to 200 kg/m

Belt Width: 600-1800mm

Maximum Belt Speed: 5.0 m/s

Applications: Hard Rock Mining, Limestone Quarrying, Load-out Facilities

Adjustable Idler Frame

- Uses Flexco CoreTech® idlers
- For use around load zone to lift belt off beds
- Features adjustable trough frames in 5° increments
- Useful for transition area



Specifications:

Idler Rating: CoreTech® roll - No impact

CoreTech Impact roll - 200 lb/ft

Applications: For use between every two Flexco beds, transitions

Applications listed are intended to identify where each impact bed is commonly and most effectively utilised. Material size, lump weight and drop height should all be considered before making a final product selection. Consult Flexco to assess specific applications and recommendations.



FLEXCO SKIRTING SYSTEMS

Specially designed to create an effective seal at load points without damaging the top cover of your belt, our skirting systems are a smart way to improve throughput.

Flex-Seal™ Skirting System

- Dynamic containment unit that fully seals the loading zone
- Sturdy, corrosion-resistant components that deliver long service life
- Easy to install and maintain

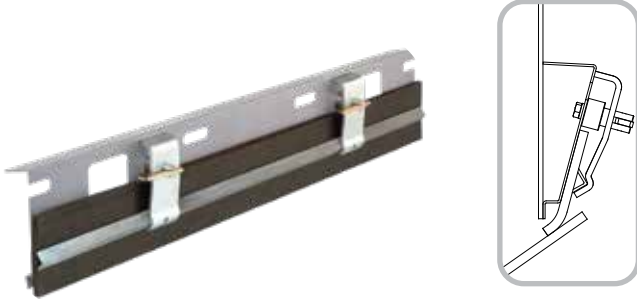

Specifications:

Module Sizes: 1200 mm (4')

Skirting Sizes: For skirt rubber 150 mm (6") wide and from 8–19 mm (5/16"–3/4") thick

Flex-Lok™ Skirt Clamps

- Heavy-duty applications
- Strong restraining bar that is held in place by clamp plates to allow easy adjustment of skirt rubber
- Anti-vibration clamp pin can be unlocked with a rubber hammer
- Easy to install and maintain
- Mini Flex-Lok™ option available—overall height of 40mm



Specifications:

Module Sizes: 2000 mm

Skirting Sizes: For skirt rubber from 8–25 mm thick

Polyurethane Skirting

- Polyurethane skirting offers a more wear-resistant material than typical rubber
- Lower coefficient of friction reduces strain on the system
- Works with Flexco's skirt clamp options that offer simple serviceability
- 35° chamfer eliminates the typical skirting break-in period
- Soft durometer (65A) polyurethane with exceptional tear resistance to ensure a good seal and long belt life
- Also available in a dual seal option

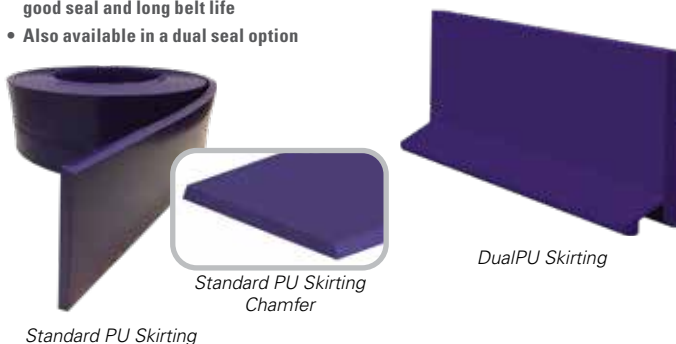

Specifications:

Rated for temperatures from -30°C to 82°C

RMC1 Skirt Clamps

- Simple installation, no-hassle maintenance
- Versatile design that can be installed on vertical or perpendicular skirt boards
- Anti-vibration clamp pin
- Interlocking clamp plates and 1200 mm clamp bar
- Limited Space (LS) option available

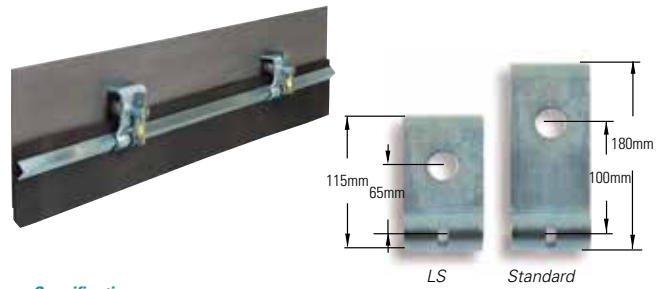

Specifications:

Module Sizes: 1200 mm

Skirting Sizes: For a range of skirt rubber heights; for thicknesses from 8–19 mm thick

PAL Paks

- Safe, easy-to-install skirt clamps
- Clamp pins bolt or weld directly to skirt board
- Bolt-on version provides no-weld solution to eliminate sparking risks
- Limited Space (LS) option available
- Clamp plates are 180 mm high (LS version 115 mm)



Specifications:

Skirting Sizes: For a range of skirt rubber heights; for thicknesses from 8–19 mm thick

Enclosed Skirting System

- Easy installation
- Seal skirting to your conveyor belt using vertical or tangential sealing options
- Rear door seal provides easy access for wash-down, inspection or repairs
- Dust curtains control air flow throughout the system to keep dust levels low
- Adjustable liners provide increased skirt liner life



How to Select the Right Belt Plough

When choosing a plough to prevent fugitive material from finding its way into your tail pulley, you need to consider where you want to discharge any debris.

To discharge material to a single side of the belt:
Choose the RDP1 Diagonal Plough.

To discharge material to both sides of the belt:
Choose the V-Plough.

FLEXCO PLOUGHS

FEATURES & APPLICATIONS

Flexco offers two advanced ploughs that prevent costly damage to tail pulleys and gravity take-ups, while cleaning the inside of the belt.

RDP1 Diagonal Plough

- Discharges debris to one side of belt
- Unique angled blade that creates effective "spiral" action
- Fixed position eliminates bouncing and vibration problems
- Appropriate for use at any point along inside of return belt
- Simple and quick installation and blade replacement



Specifications:

Maximum belt speed: 3.5 m/s
Belt Widths: From 450–2400 mm

Diagonal Plough

- Discharges debris to one side of belt
- Unique angled blade that creates effective "spiral" action
- Fixed position eliminates bouncing and vibration problems
- Appropriate for use at any point along inside of return belt
- Simple and quick installation and blade replacement



Specifications:

Maximum belt speed: 3.5 m/s
Belt Widths: From 450–2100 mm

V-Plough

- Simultaneously discharges debris to both sides of belt
- Angled blade design "spirals" away debris and water
- Easy to install and maintain
- Fits virtually any conveyor structure
- Turnbuckle at nose allows for fine-tuning at installation



Specifications:

Maximum belt speed: 5 m/s
Belt Widths: From 450–1800 mm

Twin Pole V-Plough

- Cleans the inside/clean side of return belt
- Floating design self-adjusts as blade wears
- UHMWPE blades provide long-life and easy change-out



Specifications:

Maximum belt speed: 6 m/s
Belt Widths: From 900–3000 mm

Heavy-Duty Floating Blade Plough

- Eliminates conveyor damage and belt mistracking caused by debris lodging in the tail pulley or take-up
- Floating blade self-adjusts as blades wear, eliminating the need for manual adjustment
- Fail-safe fixed frame so as the blade wears, the frame will never touch the belt
- Deflecting shields prevent rocks and debris rebounding over plough
- Available in stainless steel with FRAS approved blades for use in underground environments
- Cleans the inside/clean side of the belt



Specifications:

Belt Widths: From 900–3000 mm

YOUR ISSUE: ROLLER LIFE AND WEIGHT OUR SOLUTION: CORETECH® NYLON AND HDPE ROLLERS

CoreTech® Tackles Common Issues

Life. CoreTech® rollers offer the best combination of structural strength coupled with the requirements of mining, which include corrosion resistance, abrasion resistance, and very low surface friction.

Corrosion. When moisture, salt, or other corrosive materials are present, CoreTech provides an excellent alternative to steel rollers. CoreTech rollers provide the same ratings as steel rollers, with no loss of functional performance, and much longer life.

Weight. CoreTech rollers are approximately 40 percent lighter than equivalent steel rolls and as the rollers get longer in the larger diameter steel rolls, that weight reduction gets closer to 50 percent. CoreTech rollers require only one individual to lift,

carry, and place the roller, increasing productivity while keeping workers safe.

Power Consumption. CoreTech rollers have lower running friction values, which, depending on the application, can decrease power bills by up to 10 percent a year. Less power is used during start-up and while in operation, contributing to lower electrical consumption.

Noise. CoreTech rollers create far less noise than steel rollers. The estimated noise contribution of CoreTech rollers is +/- 10 dB below the noise contribution of metal rollers. This noise variation can mean the difference between functioning below the maximum decibel levels and violating ordinances and compromising worker safety.

FLEXCO® CORETECH® ROLLERS

Field-Proven Seal Design

Rock Shield – The rock shield is pressed tight on the shaft and is stationary when the roller is in operation. This is the first line of defense and prevents larger material from damaging the seal.

Centrifugal Seal – The key to the CoreTech® sealing arrangement, the centrifugal seal rotates with the roller and is specifically designed to create a vortex with forces up to 9X gravity. This action expels moisture and fines that may pass the rock shield.

Deep Groove Ball Bearing – A last line of defense, all CoreTech rollers use deep groove, factory lubricated and sealed for life ball bearings. The bearing selection ensures all CoreTech rollers meet the required application ratings and protect the bearings from premature failure due to corrosion or spalling.

Bearing Housing – The bearing housing is fused to the roller tube in a way that guarantees there is no path for moisture or dust to enter the roller.

Housing Guard – The smooth surface of the housing guard provides for optimal operation of the centrifugal seal.

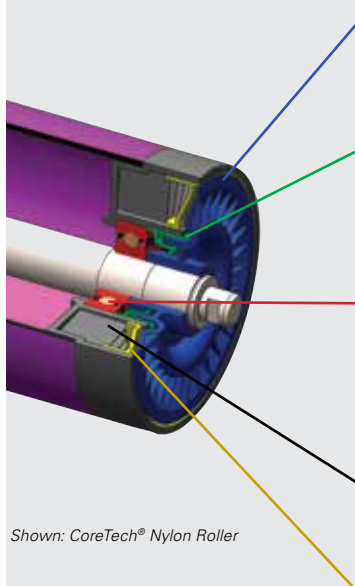

Shown: CoreTech® Nylon Roller

CoreTech® Nylon Rolls – The next generation of troughing and return rolls are made of lightweight, high strength, corrosion and abrasion resistant composite material. Plus belt-friendly construction means that even advanced wear on the shell won't damage the belt.

CoreTech HDPE Rolls – Highly effective workhorses for the dirtiest, most abrasive environments. They are ideal for highly corrosive, acidic environments – including those with sulfuric acid.

Specifications

CoreTech® Roller	Available Diameters	Max Face Width
Nylon	127, 152, 178mm	2750mm
HDPE	127mm	560mm

YOUR ISSUE: SLIPPAGE OUR SOLUTION: PULLEY LAGGING

There are a few factors that you should consider when selecting what lagging will work best for the belt conveyor system in question. These are as follows:

- 1. Conveyor Dynamics** – What is the belt rating (kN/m), belt thickness and pulley diameter?
- 2. Pulley Configuration** – Where on the conveyor is the pulley positioned? Drive, head, tail or bend?
- 3. Environment** – Extreme heat, cold or moisture. Extreme heat or cold can effect adhesion of rubber. Weld on Lagging or Autoclave ready lagging maybe required.
- 4. Fire Resistant Anti-Static** – In some mining and processing areas FRAS Lagging may be required.

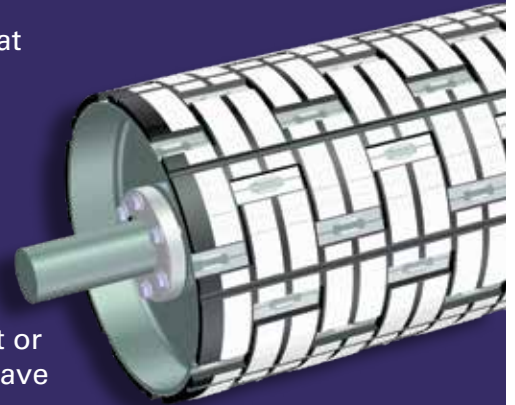

Use the following chart to identify the best Flex-Lag® Pulley Lagging for your needs.

Criteria	Flex-Lag® Rubber			Flex-Lag® Ceramic			Flex-Lag® Weld-On™	
	Light Duty	Plain	Diamond	Diamond Pattern	Medium Ceramic	Full Ceramic	Rubber Diamond	Full Ceramic
Thickness Range Available*	7.5 mm	10 – 25 mm	10 – 30 mm	12 – 30mm	12 – 30 mm	12 – 30mm	15 mm	15 mm
Belt Width*	Any Width	Any Width	Any Width	Any Width	450 – 3000 mm	450 – 3200 mm	450 – 3200 mm	450 – 3200 mm
Minimum Pulley Diameter**	50 mm	300 mm	300 mm	300 mm	300 mm	300 mm	400 mm	400 mm
Dry Friction	Very Good	Excellent	Very Good	Very Good	Excellent	Excellent	Very Good	Excellent
Wet Friction	Average	Average	Good	Very Good	Excellent	Excellent	Good	Excellent
Wet/Muddy Friction	—	Average	Very Good	Very Good	Very Good	Very Good	Very Good	Very Good
Wear Life	Good	Good	Good	Very Good	Excellent	Best	Good	Best
Ease of Installation	Good	Good	Good	Good	Good	Good	Best	Best
Drainage Grooves	No	Yes						
FRAS (Fire Resistant Anti-Static)	No	Available						
Rubber Compound	SBR							
Hardness (Shore A)	68 +/- 3							
Ceramic Compound	—	—	—	Al ₂ O ₃	Al ₂ O ₃	Al ₂ O ₃	—	Al ₂ O ₃
Ceramic Coverage	—	—	—	15%	39%	80%	—	74%
Can be used in an autoclave (with application of uncured rubber)	Yes	Yes	Yes	Yes	Yes	Yes	No	No
Operating Temperature	-15° – 85° C							
COF Values	Ask Your Local Sales Representative							

*Additional thicknesses and widths available as special orders. For weld-on lagging, thickness includes the backing plate.

**Minimum pulley diameters are based on 10-12mm lagging thicknesses.

FLEXCO PULLEY LAGGING

Light-Duty Rubber Lagging

- Specially designed for pulleys with diameters as small as 50 mm.
- Moisture is channeled between small raised buttons that support and grip the belt and deliver superior traction.
- Available in SBR and White Nitrile.
- Can be made in rolls up to 75m long, dependent on lagging thickness.



Belt Width: Any Width

Plain-Pattern Rubber Lagging

- Helps prevent belt slippage in dry environments.
- Provides larger surface contact area relative to other patterned lagging.
- Horizontal grooves channel water and debris while providing a better dynamic interaction with the belt compared to sheet lagging.
- Available with FRAS approved rubber, marked in blue for easy identification on site.



FRAS

Belt Width: Any Width

Diamond-Pattern Rubber Lagging

- Diamond pattern features a bidirectional design for superior water-shedding characteristics.
- Horizontal grooves provide a second method to disperse water and debris off the lagging and prevent hydroplaning.
- Performs well in both dry and wet applications.
- Available with FRAS approved rubber, marked in blue for easy identification on site.
- Available in rolls up to 75m.

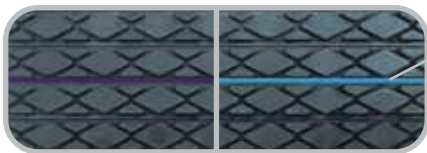

FRAS

Belt Width: Any Width

Diamond Pattern Ceramic Lagging

- 15% tile coverage.
- Large ceramic tile is molded into the diamond section, providing an increased coefficient of friction vs. Diamond-Pattern Rubber.
- Also features a bidirectional design for superior water-shedding characteristics.
- Uses the advantages of a ceramic product at a more affordable cost in light or medium duty applications.
- Available with FRAS approved rubber, marked in blue for easy identification on site.

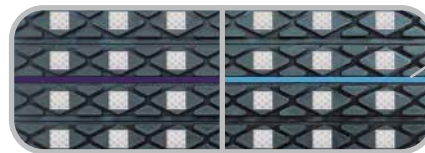

FRAS

Belt Width: Any Width

Medium Ceramic Lagging

- 39% tile coverage.
- Ceramic tiles increase coefficient of friction between the belt and drive pulley in wet or variable conditions.
- Constructed from individual ceramic tiles molded into a high-durometer rubber for excellent abrasion resistance.
- Molded ceramic buttons grip the belt's underside for positive traction.
- Excellent friction for mid-range tension belts.
- Available with FRAS approved rubber, marked in blue for easy identification on site.
- Smooth ceramic available on demand. Also available in 40 metre rolls.



FRAS

Belt Width: from 450 - 3000 mm

Full Ceramic Lagging

- 80% tile coverage.
- Ceramic tiles increase coefficient of friction between the belt and drive pulley in wet or variable conditions.
- Constructed from hundreds of individual ceramic tiles molded into a durable rubber backing with a higher coverage than Medium Ceramic for best-in-class abrasion resistance.
- Molded ceramic buttons grip the belt's underside for positive traction.
- Best for high-tension belts.
- Available with FRAS approved rubber, marked in blue for easy identification on site.
- Smooth ceramic available on demand.

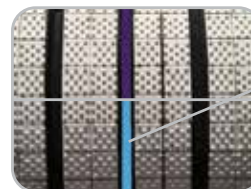

FRAS

Belt Width: from 450 - 3000 mm

Weld-On Ceramic Lagging

- 74% tile coverage.
- Weld-On design allows for quick, in-situ installation.
- Gear-tooth layout protects cleaners on pulley from experiencing "chatter" and premature wear.
- Constructed from hundreds of individual ceramic tiles molded into a durable rubber backing.
- Most consistent performance in dry, wet or muddy applications.
- Molded ceramic buttons grip the belt's underside for positive traction.
- Also available in rubber and FRAS.

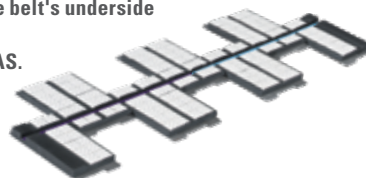

Minimum Pulley Diameter: 400 mm
Belt Width: from 450 - 1800 mm

Flexco Pulley Lagging Adhesives

Flex-Lag adhesives are a two-part cold bonding system designed specifically for use with rubber-to-rubber and rubber-to-metal adhesion. Flex-Lag adhesives are also produced without using chlorofluorocarbons (CFCs). An excellent bond is achieved while using minimal amount of cement and primer thanks to high adhesion during installation and after curing.





QUALITY ASSURANCE PROCESS

 We periodically test our rubber properties, such as tensile strength, elongation, and bonding strength to ensure they remain unchanged and compliant to our specifications.

 We complete an inspection sheet for each production order and monitor the quality of the products.

 We test the chemical composition of our tiles to ensure they remain unchanged to achieve maximum wear resistance and bonding strength.

 We source our rubber from reputable rubber manufacturers with extensive knowledge and after-sales technical support.

 We work with universities to get independent test results to hold ourselves to the highest professional standard.

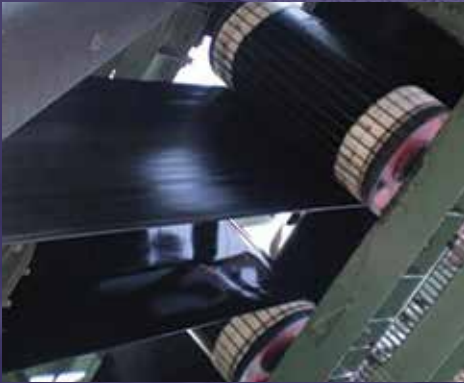

OUR WORK

We're proud of our Australian made lagging. We produce it for Flexco subsidiaries around the world and it's been tested in the harshest global conditions. We have application profiles and a white paper written by chief engineer, Brett Devries on the implication of lagging on conveyor design available on www.flexlag.com, access by scanning the QR code.



FLEXCO SERVICES

Inspection, Installation and Maintenance

Around the world, Flexco has your operation covered. Whether it be with our factory-trained and certified Flexco resources or our trained distributor partners, we're there to ensure you maximise the return on your investment by making sure Flexco's products are properly specified, installed, or maintained.

Ensuring the product is installed correctly and maintained is critical to provide the optimal results our products are engineered to deliver. Flexco takes pride in making sure you have access to the resources that make certain the products exceed your expectations.

Conveyor Assessments

Having a third party review your conveyor system can prove to be an effective way to identify performance, maintenance and safety concerns that can be critical to minimising downtime and maximising your productivity.

Flexco's assessment program allows you to proactively address belt conveyor concerns before they lead to costly repairs and unscheduled downtime. Focusing on issues such as spillage, carryback, belt slippage, and mistracking, Flexco specialists will record their findings and return to your operation with a complete recommendation on the system, identifying immediate needs and suggesting future fixes.



Training

Flexco offers training programs around the world that are flexible to meet your needs and requirements. Our programs range from coming to your site to train a maintenance team to hosting you at one of our Flexco training centres at 10 locations around the world as well as online programs. Our comprehensive Flexco University program delivers the knowledge and skills required to ensure you keep your belts running effectively and efficiently, balancing both classroom and field instruction to deliver a detailed, thorough education program.



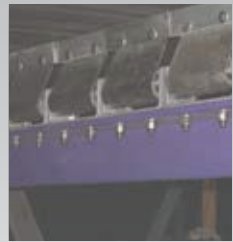
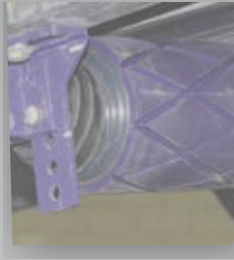

Visit our website or contact your local distributor to learn more.
www.flexco.com.au



Flexco (Aust.) Pty. Ltd • 10 Solent Circuit, Norwest • NSW, Australia, 2153 • Australia
Tel: 612-8818-2000 • Fax: 612-8824-6333 • E-mail: salesau@flexco.com

Visit www.flexco.com for other Flexco locations and products.

©2022 Flexible Steel Lacing Company. 11/29/22. For reorder: X5963



Partners in Productivity