

FGP Food Grade Precleaner

USDA Certified Precleaner Meets Highest Standards for Industrial Baking Applications

The FGP Food Grade Precleaner from Flexco is the most effective food grade cleaner on the market at removing dough, flour, oils, frosting, and other sticky materials from the conveyor belt. And it is easy to install, maintain, and disassembles in a snap for regular cleaning, allergen cleansing, and sanitization. That means your pre-bake or post-bake lines can be up and running again fast. The FGP Precleaner works on any belt from 100mm to 1500mm and the blade is available in white, blue, metal detectable blue, and dual durometer metal detectable blue FDA-approved food grade materials.



Cleaner blades are available in blue, white, dual durometer metal detectable blue, and metal detectable blue



The FGP Precleaner is:

- Made from FDA approved materials
- USDA certified
- Compliant with EU 1935/2004 Food Contact Regulation
- Accepted by Health Canada

Cleaning blade designed to achieve optimal cleaning efficiency in even the most demanding industrial baking applications

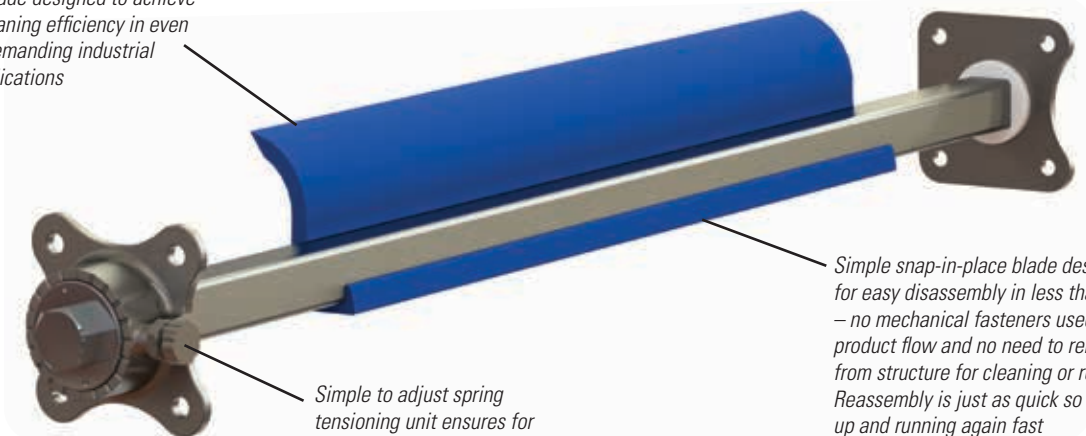

Simple to adjust spring tensioning unit ensures for maximum cleaning benefits

Simple snap-in-place blade design allows for easy disassembly in less than a minute – no mechanical fasteners used in the product flow and no need to remove cleaner from structure for cleaning or replacement. Reassembly is just as quick so your line is up and running again fast

Features and Benefits:

- Minimal hardware so installation, tensioning, and blade replacement are easy.
- Simple design with stainless steel components and food grade materials limit crevices and opportunities for bacteria growth.
- Easily tensioned to minimize blade wear, eliminate belt damage, and maximize cleanability.
- Optional metal detectable blue blade for additional protection against food contamination.
- Dual durometer blade with metal detectable tip for uneven or soft cover belts.
- Available in standard blade widths for belts from 300 mm to 1500 mm. Blades can be cut down to appropriate length.
- Compatible with endless and mechanical splices. Suitable for use on modular belting.



Patents: D776,396 and 0029948222-0001

www.flexco.com

FLEXCO

FGP Food Grade Precleaner

Specifications:

- **Temperature Range**
UHMW:
-29°C to 60°C
Dual Durometer:
(0°C to 60°C)
- **Blade Height**
76 mm
- **Blade Width Range**
102 to 1524 mm
- **Pole/Mounting Material**
304 Stainless Steel
- **Blade Hardness**
UHMW:
63D Shore Hardness
Urethane:
85A Shore Hardness
- **Pulley Diameter Range**
50 to 267 mm
- **Blade Material**
Food-grade UHMW, UHMW
with Stainless Steel, or
Urethane with PVC

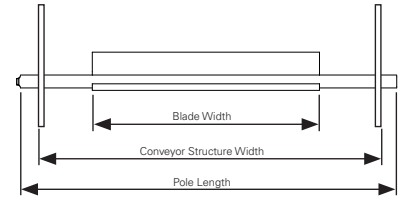

How to choose the correct size blade for your conveyor.

1. Measure your belt width.
2. Choose the Blade Width that corresponds to your belt width.
3. Measure your conveyor width.
4. Verify the Maximum Conveyor Width shown in the selection chart is larger than your conveyor width. If your conveyor width is smaller than the maximum width shown, choose the next larger blade width that accommodates your conveyor width.
5. Blade and/or pole can be cut to users required length. Pole must be 50mm longer than the outside width of conveyor structure at the mounting location.

Pole Lengths				
Pole Length	Standard Blade Length	Minimum Blade Length	Minimum Conveyor Width at Cleaner Mounting Location	Maximum Conveyor Width at Cleaner Mounting Location
mm	mm	mm	mm	mm
610	305	229	279	556
813	457	229	356	708
965	610	229	508	861
1067	762	457	660	1013
1219	914	457	813	1165
1372	1067	457	965	1318
1524	1219	457	1118	1470
1676	1372	457	1270	1623
1829	1524	457	1422	1775

*Pole length = blade length + 300mm on standard cleaners.

FGP Food Grade Precleaner										
Blade Width	Maximum Conveyor Width	Weight	White Blade		Blue Blade		Blue Metal Detectable Blade		Blue Dual Durometer Blade*	
			Ordering Number	Item Code	Ordering Number	Item Code	Ordering Number	Item Code	Ordering Number	Item Code
305	559	3.0	FGP-W3-12	56009	FGP-BL3-12	56000	FGP-MD3-12	56027	FGP-MDDD3-12	56018
457	711	3.5	FGP-W3-18	56010	FGP-BL3-18	56001	FGP-MD3-18	56028	FGP-MDDD3-18	56019
610	864	3.9	FGP-W3-24	56011	FGP-BL3-24	56002	FGP-MD3-24	56029	FGP-MDDD3-24	56020
762	1016	4.3	FGP-W3-30	56012	FGP-BL3-30	56003	FGP-MD3-30	56030	FGP-MDDD3-30	56021
914	1168	4.8	FGP-W3-36	56013	FGP-BL3-36	56004	FGP-MD3-36	56031	FGP-MDDD3-36	56022
1067	1321	5.2	FGP-W3-42	56014	FGP-BL3-42	56005	FGP-MD3-42	56032	FGP-MDDD3-42	56023
1219	1473	5.6	FGP-W3-48	56015	FGP-BL3-48	56006	FGP-MD3-48	56033	FGP-MDDD3-48	56024
1372	1626	6.0	FGP-W3-54	56016	FGP-BL3-54	56007	FGP-MD3-54	56034	FGP-MDDD3-54	56025
1524	1778	6.4	FGP-W3-60	56017	FGP-BL3-60	56008	FGP-MD3-60	56035	FGP-MDDD3-60	56026

*Dual durometer blade is not compliant with Health Canada or EU 1935/2004.

FGP Optional Mounting Brackets (Bolt or Weld)			
Description	Ordering Number	Item Code	
1 Frame Mount	FGP-MOUNT-FRAME	56585	
2 Flange Bearing Mount	FGP-MOUNT-FLANGE-BEARING	56586	
3 Base Bearing Mount	FGP-MOUNT-BASE-BEARING	56587	
4 Two-Piece Mount	FGP-MOUNT-TWO-PIECE	56588	

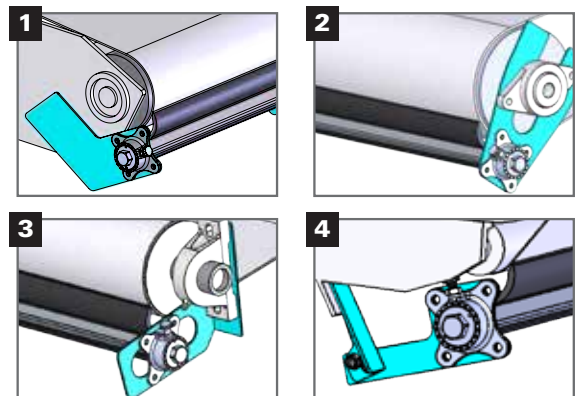

Authorised Distributor: