

# 900 Series Belt Cutter

## Instructions

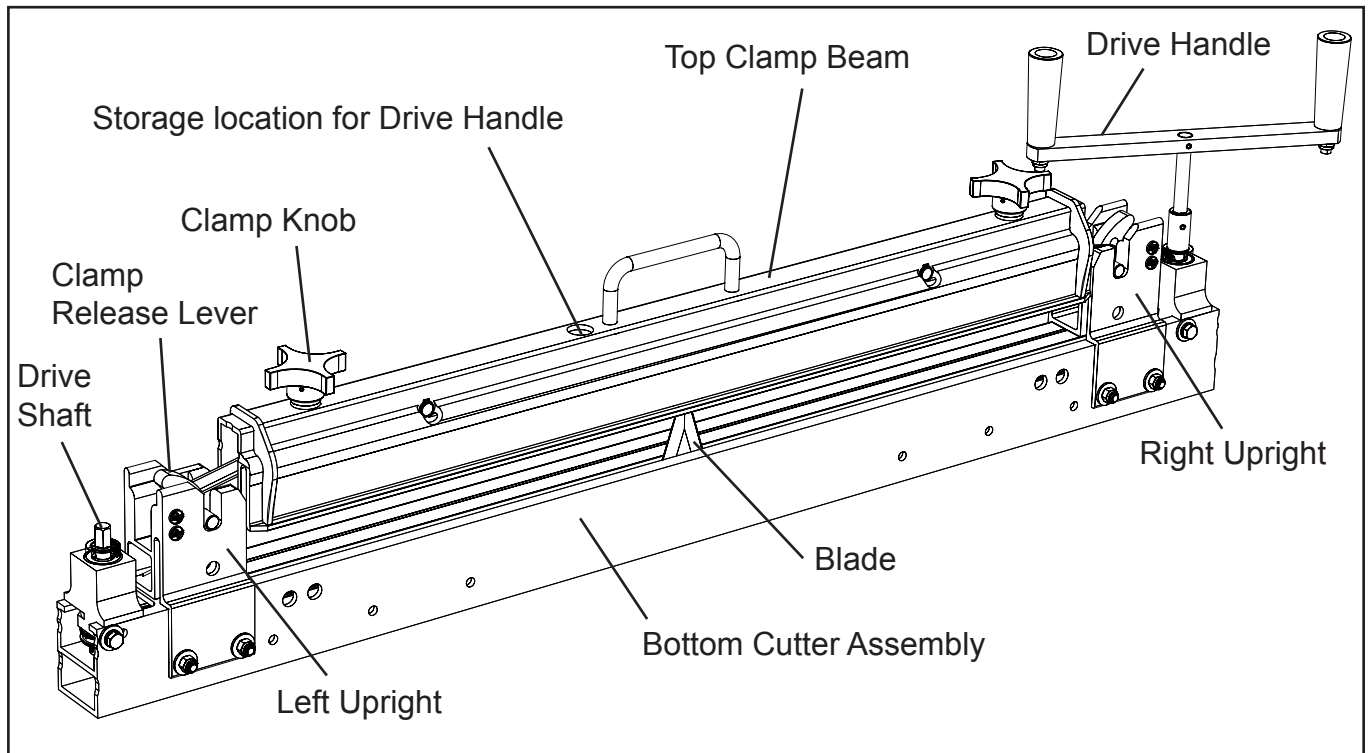

1. Square belt using center line method (Fig. 1).

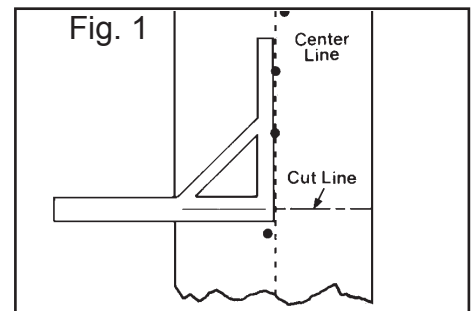

2. If belt clamp is fully tightened down, release pressure by turning belt clamp knobs counterclockwise slightly (Fig. 2).

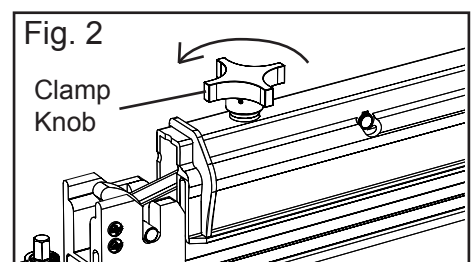

3. Remove top belt clamp assembly. Push down clamp release levers and pull top clamp beam off cutter (Fig. 3).

**CAUTION:**

\*Avoid contact with serrated belt grips on top beam.

\*Avoid contact with cutter blade if exposed.

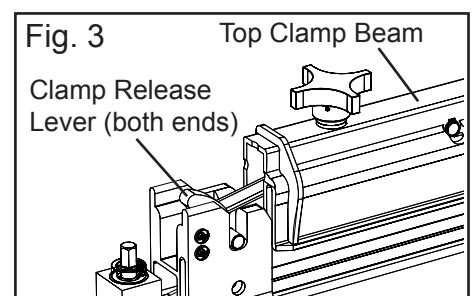

4. Remove drive handle from storage location and install on drive shaft (Fig. 4).

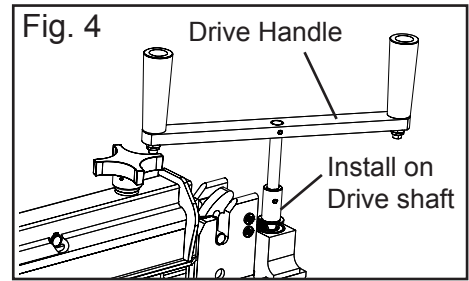

5. Turn drive handle to move the blade to the end of the cutter opposite the end you will be operating from. Ensure blade is in the guarded upright.

6. Position bottom cutter assembly under belt.

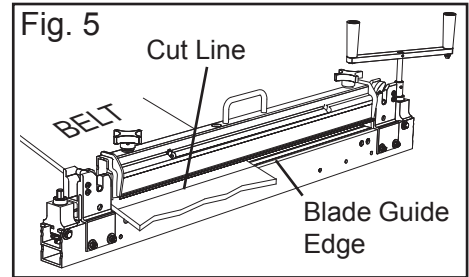

7. Re-install top clamp beam. NOTE: Align "Right" label on clamp assembly with matching label on right upright.

8. Position belt against end of cutter, opposite the blade.

9. Align marked cut line with the blade guide edge (Fig. 5).

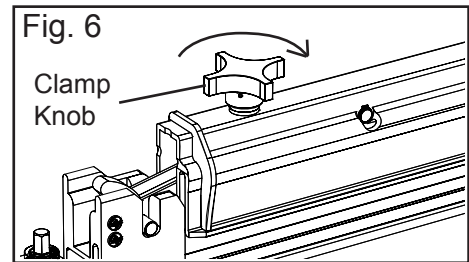

10. Tighten belt clamp knobs evenly until uniform tension is achieved across full belt width (Fig. 6).

11. Turn drive handle until cut is complete. Ensure blade is fully enclosed in the guarded upright.

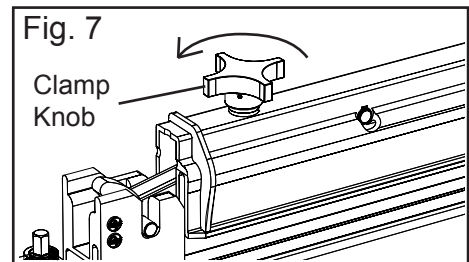

12. Loosen belt clamp knobs to release tension (Fig. 7).

13. Release top clamp beam by depressing clamp release levers (Fig. 8).

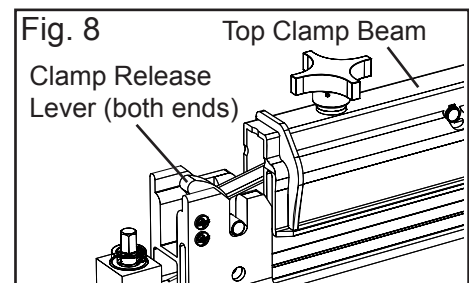

**CAUTION:**

- \* Avoid contact with serrated belt grips on top beam.
- \* Avoid contact with cutter blade if exposed.

14. Remove cutter from work area.

15. Reassemble belt clamp assembly to cutter with drive handle positioned in the storage area (Fig. 9).

