

Novitool® Aero® Splice Press Safety and Operation Manual

Aero 325, 625, 925, 1225, 1525, 1835, and 2135



 **WARNING**

IMPROPER OR UNSAFE use of this tool can result in serious bodily injury! This manual contains important information about product function and safety. Please read and understand this manual BEFORE operating the tool. Please keep this manual available for other users and owners before they use the tool. This manual should be stored in a safe place.

Patents: www.flexco.com/patents

Table of Contents

Main Components.....	3
Description.....	4
Preheat Function	4
Machine Specifications	5
Transport Case.....	7
General Safety Rules.....	7
Press Lifting and Rigging Guidelines.....	9
Operation of the Aero® Press	10
Instructions for Use with Belt Templates	21
Press Options	26
Recipes	27
Technical Assistance	30
Aero® Press End Plate Removal and Reassembly	31
Electrical Diagrams of Power Supply Cables.....	43
Electrical Schematics	45
Diagnostics.....	60
Maintenance.....	61
WEE	62
CE Declaration.....	63

Main Components Aero[®] Splice Press

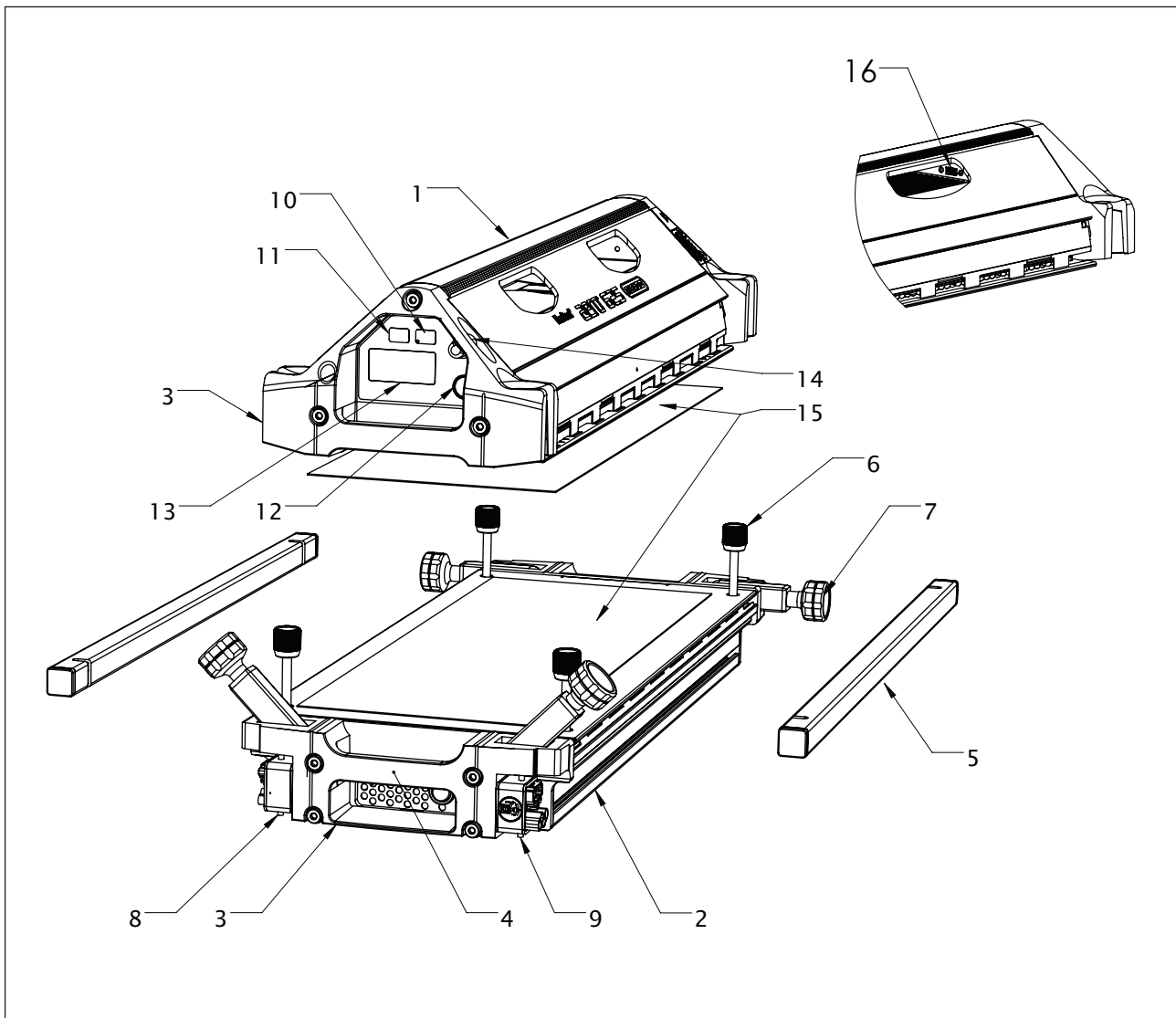

- | | | | |
|----------------------|--------------------------------------|-----------------------------------|---------------------------------|
| 1. Top Press Beam | 5. Clamp Bars (2) | 9. Main Power Cable Connector | 13. Display Screen |
| 2. Bottom Press Beam | 6. Clamp Bar Studs and Thumbnuts (4) | 10. Start Button (Green) | 14. Selector Knob |
| 3. End Plates | 7. Press Connector Bolts (4) | 11. Stop Button (Amber) | 15. Silicone Release Cloths (2) |
| 4. Handle | 8. Umbilical Power Cable Connector | 12. Pressure Relief Button (Blue) | 16. USB Port |

Description

The Novitool® Aero® is the premier, state-of-the-art splice press for splicing thermoplastic conveyor belts (e.g. PVC, Polyurethane), with the following features:

- Press is compatible with multiple power sources. See pages 5 and 6 for specifics.
- Top and bottom temperatures can be set independently up to max. 200 °C (392 °F)
- Splice pressure is applied by an internal compressor, max 28 psi (2 bar)
- Forced air cooling technology in both top and bottom beams
- Internal electronic controls
- Internal splice value recipe database
- Preheat function

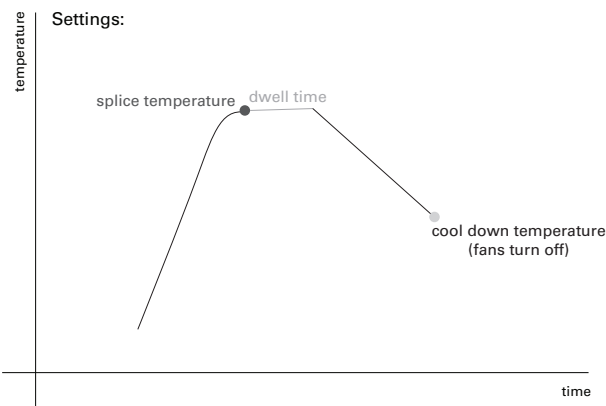

Understanding Preheat Function

If belt is relatively thick, a problem might occur where the outside of the belt is at the splicing temperature too long, waiting for the inside to reach the required temperature. Melted material might flow away or discolor and fabrics might shrink. To avoid this problem, the preheat option can be used. This option heats the belt up (outside and inside) to a temperature just below the melting temperature. After the preheat stage, the inside splice temperature can be reached much quicker, minimizing the risk for unwanted flow of material, discoloring or shrinkage.

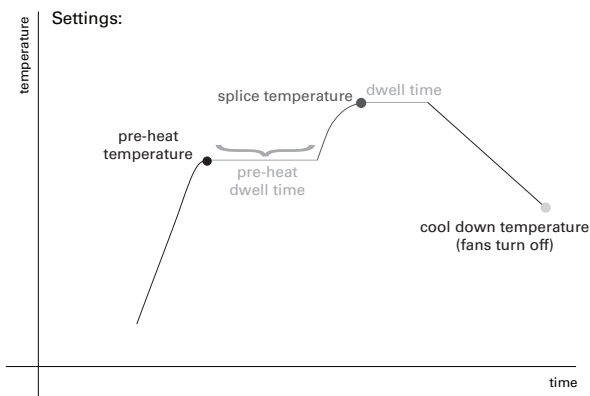

Aero[®] 325, 625, 925, and 1225

Aero[®] Tool Specifications					
Specifications	Country	Aero [®] 325	Aero [®] 625	Aero [®] 925	Aero [®] 1225
Effective splice length	N/A	325 mm/12.8"	625 mm/24.6"	925 mm/36.4"	1225 mm/48.2"
Effective splice width	N/A	150 mm/6"	150 mm/6"	150 mm/6"	150 mm/6"
Upper weight	N/A	11.5 kg/25 lbs.	18.23 kg/40.2 lbs	24.6 kg/54.2 lbs	30.4 kg/67 lbs
Lower weight	N/A	13 kg/29 lbs.	20.8 kg/45.8 lbs	26.8 kg/59.1 lbs	33.1 kg/72.9 lbs
Total weight	N/A	24.5 kg/54 lbs.	39.9 kg/87.9 lbs	52.7 kg/116.2 lbs	65.2 kg/143.7 lbs
Overall length	N/A	521 mm/20.5"	825 mm/32.5"	1125 mm/44.3"	1425 mm/56.1"
Height upper beam	N/A	160 mm/6.3"	160 mm/6.3"	160 mm/6.3"	160 mm/6.3"
Height lower beam	N/A	85 mm/3.3"	85 mm/3.3"	85 mm/3.3"	85 mm/3.3"
Overall height	N/A	245 mm/9.6"	245 mm/9.6"	245 mm/9.6"	245 mm/9.6"
Max. splice stack up	N/A	15 mm/0.6"	15 mm/0.6"	15 mm/0.6"	15 mm/0.6"
Max. pressure	N/A	2 bar/28 psi	2 bar/28 psi	2 bar/28 psi	2 bar/28 psi
Max. temperature	N/A	200° C/392° F	200° C/392° F	200° C/392° F	200° C/392° F
Temperature ratings	N/A	-20C to +40C Operating -25C to +50C Storage	-20C to +40C Operating -25C to +50C Storage	-20C to +40C Operating -25C to +50C Storage	-20C to +40C Operating -25C to +50C Storage
Transport dimensions	N/A	35.4" x 16" x 25" 900 mm x 405 mm x 635 mm	47.2" x 16" x 25" 1200 mm x 405 mm x 635 mm	59" x 16" x 25" 1500 mm x 405 mm x 635 mm	71" x 16" x 25" 1800 mm x 405 mm x 635 mm
Cable/Amp Draw					
1ph 110V, 15A	USA	10.0 A	9.1 A	N/A	N/A
1ph 110V, 20A	USA	10.0 A	9.1 A	12.3 A	15.9 A
1ph 110V, 16A	UK	10.0 A	9.1 A	12.3 A	15.9 A
1ph 230V, 10A	AUS	5.5 A	9.6 A	7 A	9.1 A
1ph 230V, 13A	UK	5.5 A	9.6 A	7 A	9.1 A
1ph 230V, 16A	EUR	5.5 A	9.6 A	12.9 A	9.1 A
1ph 230V, 30A	USA	5.5 A	9.6 A	12.9 A	16.7 A
3ph 230V, 20A	USA	5.5 A	8.4 A	11.3 A	14.6 A
3ph 230V, 30A	USA	5.5 A	8.4 A	11.3 A	14.6 A
3ph 400V +N	EUR	3.2 A	4.8 A	6.5 A	8.4 A
3ph 400V no N	EUR	N/A	N/A	N/A	N/A
3ph 460V	USA	N/A	N/A	N/A	N/A

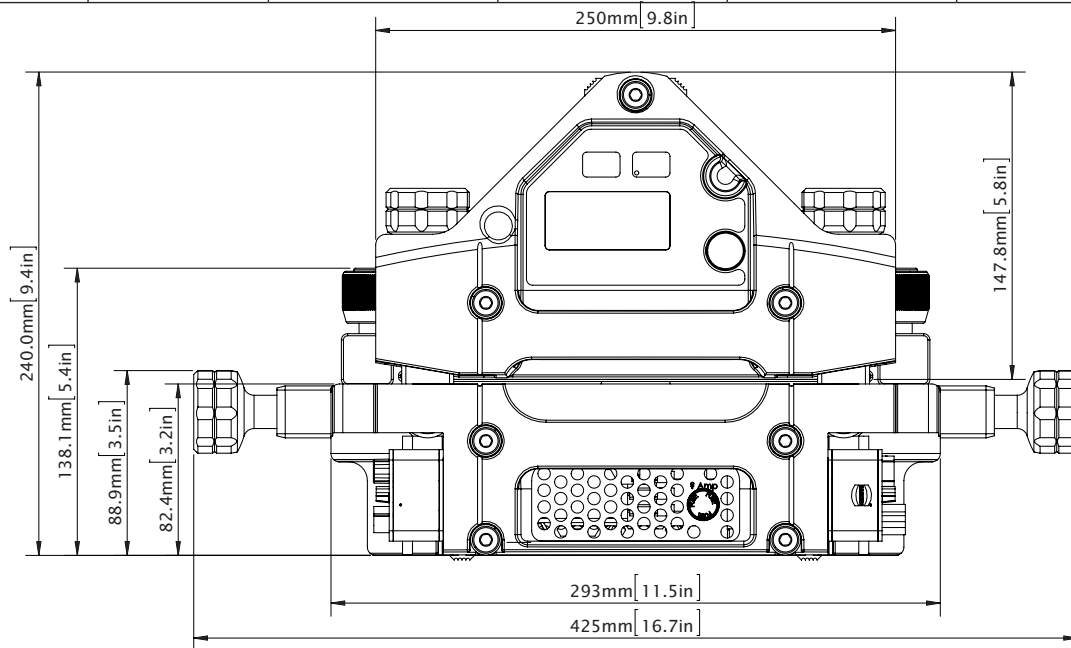

Front view and dimensions of Aero[®] presses, sizes 325-1225.



Aero[®] 1525, 1835, and 2135

Aero [®] Tool Specifications				
Specifications	Country	Aero [®] 1525	Aero [®] 1835	Aero [®] 2135
Effective splice length	N/A	1525 mm / 60"	1835 mm / 72.2"	2135 mm / 84"
Effective splice width	N/A	150 mm / 6"	150 mm / 6"	150 mm / 6"
Upper weight	N/A	43.6 kg/96.2 lbs	50 kg/110.2 lbs	56.6 kg/124.8 lbs
Lower weight	N/A	45.7 kg/100.8 lbs	52.6 kg/115.9 lbs	60 kg/132.3 lbs
Total weight	N/A	91.5 kg/201.6 lbs	105 kg/231.7 lbs	119.4 kg/263.2 lbs
Overall length	N/A	1725 mm / 67.9"	2025 mm / 79.7"	2325 mm / 91.5"
Height upper beam	N/A	185 mm / 7.3"	185 mm / 7.3"	185 mm / 7.3"
Height lower beam	N/A	140 mm / 5.5"	140 mm / 5.5"	140 mm / 5.5"
Overall height	N/A	325 mm / 12.8"	325 mm / 12.8"	325 mm / 12.8"
Max. pressure	N/A	2 bar / 28 psi	2 bar / 28 psi	2 bar / 28 psi
Max. splice stack up	N/A	15 mm/0.6"	15 mm/0.6"	15 mm/0.6"
Max. temperature	N/A	392 °F / 200 °C	392 °F / 200 °C	392 °F / 200 °C
Temperature ratings	N/A	-20C to +40C Operating -25C to +50C Storage	-20C to +40C Operating -25C to +50C Storage	-20C to +40C Operating -25C to +50C Storage
Transport dimensions	N/A	2100 mm x 405 mm x 710 mm 82.7" x 16" x 28"	2450 mm x 405 mm x 710 mm 96.5" x 16" x 28"	2500 mm x 533 mm x 710 mm 98.4" x 21" x 28"
Cable/Amp Draw				
1ph 110V, 15A	USA	N/A	N/A	N/A
1ph 110V, 20A	USA	N/A	N/A	N/A
1ph 110V, 16A	UK	N/A	N/A	N/A
1ph 230V, 10A	AUS	N/A	N/A	N/A
1ph 230V, 13A	UK	11.2 A	N/A	N/A
1ph 230V, 16A	EUR	11.2 A	13.4 A	15.5 A
1ph 230V, 30A	USA	22.1 A	13.4 A	15.5 A
3ph 230V, 20A	USA	11.9 A	13.6 A	15.8 A
3ph 230V, 30A	USA	21.2	13.6 A	15.8
3ph 400V +N	EUR	11.4 A	13.2 A	15.1 A
3ph 400V no N	EUR	8.6 A	10 A	11.4 A
3ph 460V	USA	9.9 A	11.5 A	13 A

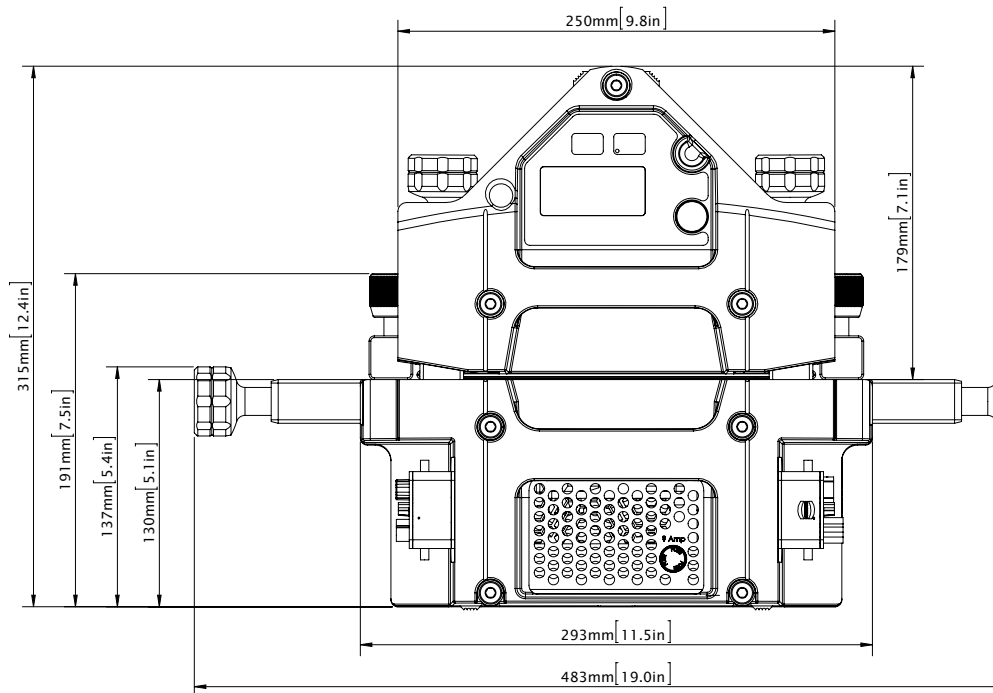

Front view and dimensions of Aero[®] presses, sizes 1525, 1835, and 2135.

Transport Case

1. Aero® presses are supplied with a transport case for both storage and easy transport to jobsites.
2. Aero® transport cases have four wheels and handle.
3. Transport cases can be stacked but need to be secured during transport.

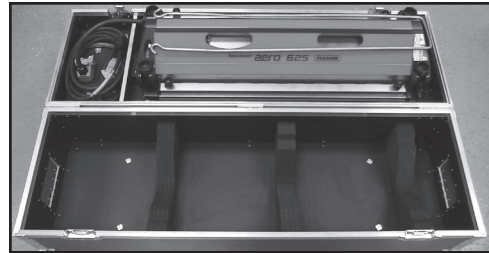
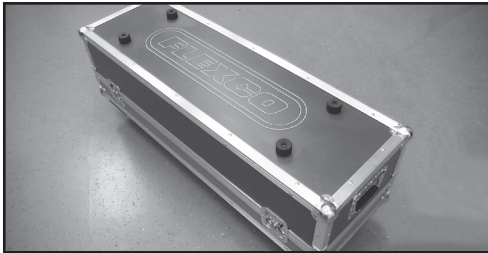

General Safety Rules – Save These Instructions

Signal words:

“DANGER” indicates an imminently hazardous situation which, if not avoided, will result in death or serious injury. This signal word is limited to the most extreme situations.

“WARNING” indicates a potentially hazardous situation which, if not avoided, could result in death or serious injury.

“CAUTION” indicates a potentially hazardous situation which, if not avoided, may result in minor or moderate injury. It may also be used to alert against unsafe practices.

Safety Symbol



This international safety symbol is used to identify and call attention to specific safety matters.

Safety Information

To avoid severe personal injury or property damage, read carefully and understand the following Safety Precautions.

1. WORK AREA

⚠ DANGER



High Voltage!

Do not operate power tools in explosive atmospheres, such as in the presence of flammable liquids, gases, or dust. Power tools create sparks which may ignite the dust or fumes.

⚠ CAUTION

Keep your work area clean and well lit.

2. ELECTRICAL SAFETY

⚠ DANGER

The Aero® is a single insulated machine and needs a multiple wire grounded power cord and grounded power supply system. Do not modify electrical cables provided.

Ensure machine, power cable and power source are not positioned in standing water or exposed to wet conditions.

Do not connect machine to power or operate machine if machine is wet. Machine intended for non-condensing/non-icing conditions. Keep cords in plastic bag when top lid handle is opened to protect from moisture.

NEVER leave power cord plugged into wall while detached from unit as this could lead to a serious electrical danger if it comes in contact with fluids, such as water.



Service shall only be performed by a qualified electrician. Power shall be removed before service. Follow Lock-Out Tag-Out procedures. Observe proper maintenance procedures. Do not modify electrical circuit.



General Safety Rules – Save These Instructions

Never alter or remove safety devices.

Operating press with extension cord will cause a voltage drop.

Operating a press with a generator may compromise the press operation and product reliability.

CAUTION

In the event of static discharge to the Aero 325 press during splice process, the press may enter a safety mode status. The display panel will advise "Warning 1 of 1". The cooling fans will turn on to lower the temperature. After the press has cooled, release the pressure by pressing the blue button. Turn the press "off". Check the splice quality. If splice needs further cooking, turn press "on" and the warning alert will have cleared.

WARNING

Operating press on incorrect voltage can cause serious damage and potential hazards. Available Aero® power cords:

- 110 volt; single phase
- 230 volt; single phase
- 230 volt; three phase
- 400 volt; three phase + neutral
- 400 volt; three phase
- 460 volt; three phase

Do not use outdoors. This machine is designed for indoor use only. The press must be transported in transport case when outdoors.

Inspect machine before each use. Ensure machine and power cable are not damaged. Machine shall not be operated with damaged controllers, power cords, or other mechanical components.

Avoid dropping or severe handling of machine at all times, including during movement in transport case.

If the electrical supply cord is damaged, it must be replaced by a special cord available from the manufacturer or its service agent.

3. PERSONAL SAFETY

WARNING

Use safety equipment. Always wear eye protection, gloves, non-skid safety shoes, and adhere to other safety standards of the facility where operating the press.

Stay alert, watch what you are doing, and use common sense when operating a machine. Do not use machine while tired or under influence of drugs, alcohol, or medication. A moment of inattention while operating machines may result in serious personal injury.

Do not wear loose clothing or jewelry. Keep your hair, clothing, and gloves away from moving parts. Loose clothes, jewelry, or long hair can be caught in moving parts.

When moving in transport case, ensure casters are unlocked and case is latched securely.

Abide by all instructions and warning labels.

This equipment is not to be used by children or persons with reduced physical, sensory or mental capabilities, or lack of experience and knowledge of the equipment.

4. USE AND CARE

WARNING

Read and understand Aero® operations manual before using machine.

Do not store solvents in Aero® transport case.

CAUTION

Only operate Aero® with machine positioned on a level, firm surface.

NEVER use a machine which is defective or operating abnormally. If machine appears to be operating unusually, making strange noises, or otherwise appears defective, stop using it immediately and arrange for repairs.

Do not use machine if switch does not turn it on or off. Any machine that cannot be controlled with a switch is dangerous and must be repaired.

General Safety Rules – Save These Instructions

Check for misalignment or binding of moving parts, breakage of parts, and any other condition that may affect machine operation. If damaged, have machine serviced before using.

In order to maintain air flow, do not cover the air inlets on top, at ends and on sides where air flows through.

Maintain machine in clean condition. Remove any oils, greases, or food product from outside and inside machine.

⚠ CAUTION

The Aero has been optimized for process speed, portability, and ease of use. A resulting affect of the designed portability is that the structure will deflect as internal air pressure is increasing during splice process. The length of press will determine how much deflection will occur at any specific pressure. Beam extrusions were designed with strength to return to their normal state when pressure is relieved; deflection will not be permanent.

Press Lifting and Rigging Guidelines

The following guidelines should be used to lift an Aero press when using equipment to assist:

1. Determine the approximate center of gravity for lifting safety before lifting the press.
2. Always test-lift the press to determine the exact unit balance and stability before hoisting it to full height.
3. Ensure that all lifting equipment is operated by qualified personnel.
4. Ensure the rigging equipment and material have the required capacity for the job and that all items are in good condition.
5. These instructions are recommendations only as other configurations may be more suitable than shown based on rigging equipment used.
6. The upper beam fan inlet holes may be used as lifting locations with straps. Attach two straps through the two furthest outside vent holes in the upper extrusion. Ensure the bottom beam connector bolts are secured.

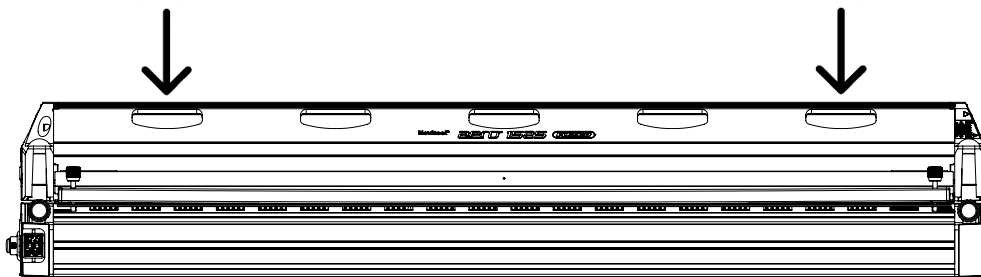











Operation of the Aero® Press

A1

Locate position in facility where appropriate voltage and power receptacles are available to operate the Aero® press.





WARNING! Only use appropriate power.

Depending on the power used, the press might operate in the 'full power' mode, which will have a quicker warm up time, or in the 'reduced power' mode. 'Reduced power' mode will take slightly longer to reach the desired dwell temperature.

Aero® Power Compatibility for 325, 625, 925, 1225, 1525, 1835, and 2135										
Item Code	Power	Country	325	625	925	1225	1525	1835	2135	Plug End
09006	1ph 110V, 15A	USA	F	R	N/A	N/A	N/A	N/A	N/A	
09007	1ph 110V, 20A	USA	F	R	R	R	N/A	N/A	N/A	
09017	1ph 110V, 16A	UK	F	R	R	R	N/A	N/A	N/A	
09364	1ph 110V, 20A		F	R	R	R	N/A	N/A	N/A	N/A
09008	1ph 230V, 10A	AUS	F	F	R	R	N/A	N/A	N/A	
09018	1ph 230V, 13A	UK	F	F	R	R	R	N/A	N/A	
09009	1ph 230V, 16A	EUR	F	F	F	R	R	R	R	
09010	1ph 230V, 30A	USA	F	F	F	F	F	R	R	
09021	1ph 230V, 16A	UK	F	F	F	R	R	R	R	
09022	1ph 230V, 32A	UK	F	F	F	F	F	R	R	
09024	1ph 230V, 20A	UK	F	F	F	R	R	R	R	
09365	1ph 230V, 30A		F	F	F	F	F	R	R	N/A

(F= full power operation, R= reduced power operation)

Operation of the Aero® Press

Aero® Power Compatibility for 325, 625, 925, 1225, 1525, 1835, and 2135										
Item Code	Power	Country	325	625	925	1225	1525	1835	2135	Plug End
09011	3ph 230V, 20A	USA	F	F	F	F	R	R	R	
09020	3ph 230V, 30A	USA	F	F	F	F	F	R	R	
09081	3ph 230V, 18-20A	TW	F	F	F	F	R	R	R	
09366	3ph 230V, 16A		F	F	F	F	R	R	R	N/A
09012	3ph 400V +N	EUR	F	F	F	F	F	F	F	
09013	3ph 400V no N	EUR	N/A	N/A	N/A	N/A	F	F	F	
09014	3ph 460V, 30A	USA	N/A	N/A	N/A	N/A	F	F	F	
09023	3ph 460V, 20A	USA	N/A	N/A	N/A	N/A	F	F	F	
09367	3ph 440V 460V, 30A		N/A	N/A	N/A	N/A	F	F	F	N/A

(F= full power operation, R= reduced power operation)

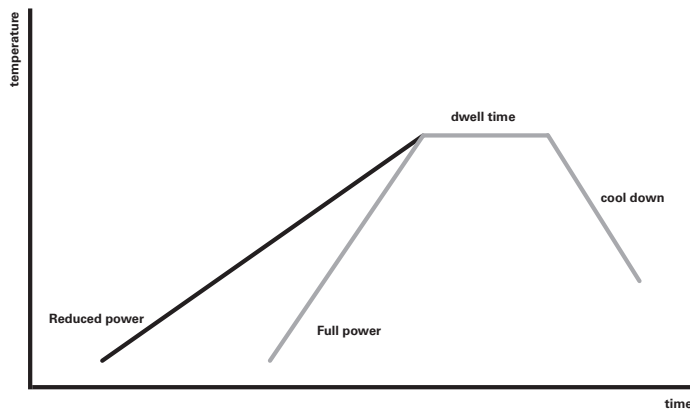

Operation of the Aero® Press

A2

Visually inspect power cable for damage and ensure power cable and plug are correct for applied power source. Power cables are labeled with appropriate voltage and amperage.

a.

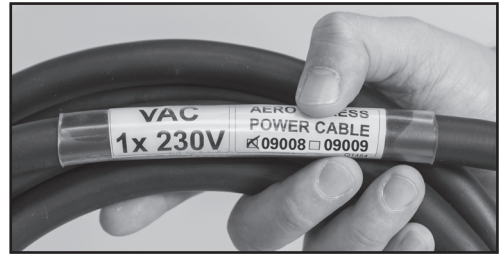

A3

Remove press from transport case in 2 sections:

a. Remove top press beam:

- i. Loosen all four press connector bolts and rotate them down.
- ii. Lift top beam from press, using top or end handles. Depending upon width and weight of the press, you may require assistance from another person.
- iii. Safely store top beam on inside of top cover. Foam inserts allow the beam to be placed either platen side down (a) or platen side up (b).

b. Remove bottom press beam from transport case and locate at splicing location.

iii a.

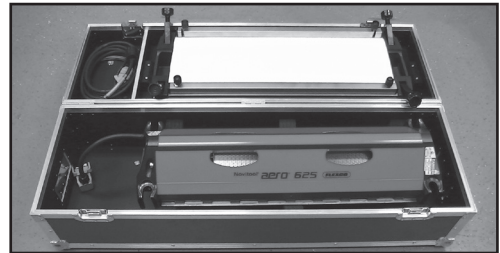

iii b.

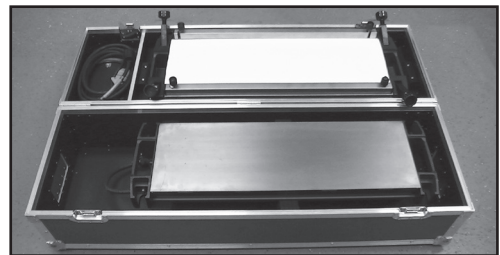

A4

Insert prepared belt ends into the press:

a. Remove clamp bars.

b. Using care, lay clean silicone pad/cloth flat over clean bottom platen. Silicone pads are used to prevent belt material from sticking to press platens. You may decide to use different release material, for a different appearance of the splice (matte or glossy). If belt has a profile on top or bottom, you may use profiled silicone pads in order to get same profile on the splice.

b.



Operation of the Aero® Press

- c. Carefully position prepared belt ends on silicone pad, centering in the splice zone. **NOTE: The splice zone is in the center 150 mm (6") width of the platen. The prepared splice and/or ply separation must be within the heated zone, as material outside the heated zone will not melt. Reference splice zone marks on end plate.** Ensure prepared belt ends are tight together. If installing a finger splice, make sure that finger tips are fully meshed without gaps. To assist with finger alignment and holding, use Aero® Splice Tape (08468) to bottom side of belt.

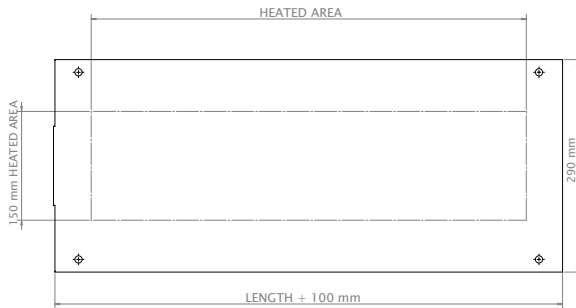

c1.



c2.



- d. If additional material in the form of splice film or foil is needed; apply it to prepared splice.
- e. To install clamp bars, loosen bolts, engage both hooked ends simultaneously and shift to side, ensuring prepared belt ends remain in place. Clamp bars may be left on during the splice cycle. Clamp bars are supplied with a camber to apply even clamping pressure across the belt width. Apply light hand pressure to clamp bar adjacent from bolt. Tighten to moderate resistance. Do NOT overtighten. This will cause a reverse camber and lessen the clamp force in the center.

e.



NOTE: Keep clamp bar sticker side up.



Operation of the Aero® Press

- f. **WARNING:** It is critical to use "bumpers" (same belt material) to fill remaining splice platen surface between the clamp bolts on each end of press. This ensures even pressure and temperature across splice width and avoids overheating or damaging press.

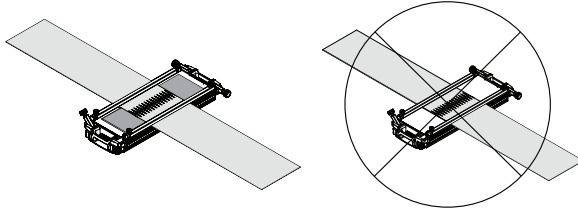

- g. Lay clean silicone pad (or other release material) over prepared splice, using care to avoid wrinkles in silicone pad.

A5

Install top press beam:

- a. Carefully position top press beam; align grooves on end plates to avoid disrupting or possibly separating fingers. Depending upon width and weight of the press, you may require assistance from another person.
- b. Aero® 925-2135 presses are provided with a roller slide fixture to aid in sliding top press beam over clamp bars, across the splice. Ensure clamp bars are secured prior to using roller slider. Put the roller slider against the clamp bar bolts as the starting position and position top beam end close to roller. Push the top beam over until it is in close proximity to the opposite end clamp bar studs. Lift top press beam at the opposite end and remove roller slide fixture. After splicing remove the top beam in reverse order. Make sure the top beam will not drop off the roller slider at the end of the stroke.

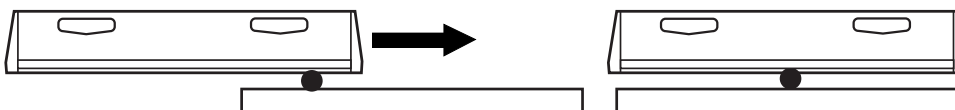
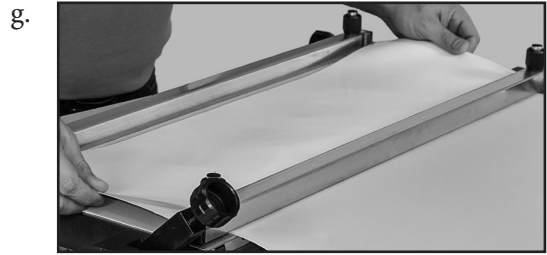
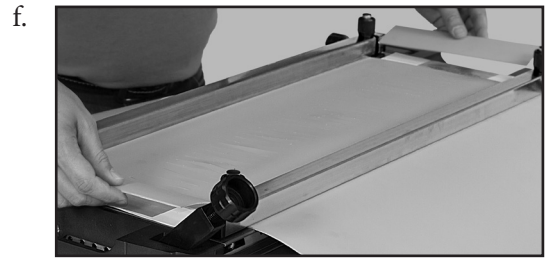

Operation of the Aero® Press

- c. With top beam properly centered above bottom beam, rotate all four press connector bolts up and hand tighten them, ensuring all bolts are seated properly in their spherical recess on top beam.

DANGER: Do not operate any press size with a missing or broken bolt, as this can cause serious physical harm and/or damage to press. If a bolt is missing or broken, replace it with authorized factory parts only. The Aero 2135 press is capable of producing a force up to 54,600 N (12,275 pounds).

WARNING: To ensure proper bolt thread engagement, the prepared splice (including various pads) may not exceed 15 mm (0.6") thick. Do not use a tool to tighten or loosen hand bolts. Over tightening bolts may lead to damage to the press. Finger tight is sufficient for proper operation.

- d. Insert umbilical cable connector into machine base connector and engage latch.

WARNING: Failure to engage latch to lock plug can result in intermittent power supply to press.

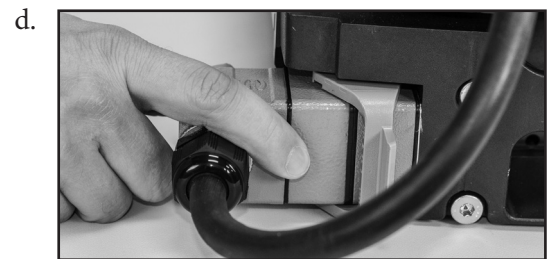

A6

Connect Aero® press to power supply

- a. First connect main power cable to main power cable connector. Engage latch.
- b. Double check to ensure power cable is appropriate for power source you are using. Power cable is labeled with voltage and amperage it is made for.
WARNING: Connecting press to incorrect power can cause serious damage to press.
- c. Insert power cable plug into appropriate wall receptacle.
WARNING: It is important that the power cord is attached to the press first and then to the wall receptacle.
- d. Turn on/off switch to on.
WARNING: Turning the on/off switch to 'off' does not disconnect power from the press.



FLEXCO

Operation of the Aero® Press

A7

Initializing Press: Prior to first time use you must register your press. This will allow Flexco to communicate critical firmware and features in the future.

- a. Screen will show press is locked and requires access code. Go to flexco.com/code to obtain your access code.
- b. Using the selector knob, scroll to “Enter Access Code” and depress knob.
- c. Scroll down, enter access code and enter “Confirm”. Contact Flexco Customer Service if you have difficulties entering the code.

A8

Display: Start Screen

- a. **Initialization screen only shows the first time the press is used.** With future uses the first screen will display for 5 seconds stating “FLEXCO NOVITool, AERO® SPLICE PRESS, www.flexco.com, Gen.3 v.x.xx”. If display stays blank, the power source might be out of order, or the wrong press-cable combination has been made (e.g. a 115V cable on a Aero® 1525 press).
- b. Next, display will show detected power cable and waits for user confirmation. This is an extra check to ensure that the right cable is connected. If the combination is correct, rotate selector knob to select “Correct” and push knob to confirm. Display advises when press will run in reduced power mode.

NOTE: Incorrect cable for wall voltage or amperage can cause serious damage to the press. Please take time to verify wall voltage and amperage matches your power cable.

a.



b.

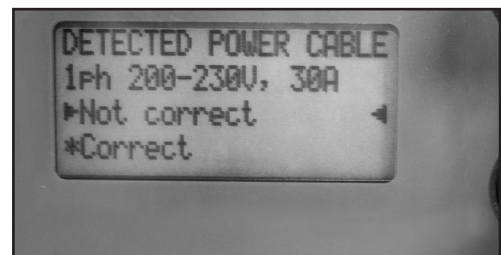

A9

Display: Home Screen

- a. The Home screen shows a number of different set values and selections. Scroll through list by rotating selector knob and select by depressing knob.

Home Screen Choices

- i. Pressure
 - ii. Switch preheat OFF/ON
 - iii. Preheat temperature (if preheat is ON)
 - iv. Preheat dwell time (if preheat is ON)
 - v. Top temperature
 - vi. Bottom temperature
 - vii. Splice dwell time
 - viii. Cool temperature
 - ix. Load Recipe
 - x. Store Recipe
 - xi. Options
- b. If a set value is chosen, all other values disappear. Once chosen, set value can be edited by rotating selector knob right or left; push knob to confirm. After confirmation, Home screen is shown again.
- c. Repeat for all set values you wish to modify. Once complete, the press is ready to start the splice process.
- d. General guidelines for initial press settings:
- i. Pressure: Typically 1.2 bar is sufficient; slightly higher pressure for profiled belt.
 - ii. Preheat: Use of preheat is not required, but it can be helpful if the splice is a thicker stack up (belt and silicone pads). Preheat allows user to soak heat into thicker belt stack up before heating up to splice temperature and reduce splice dwell time.
 - iii. Splice temperatures – to be optimized by trial splices
 1. Approximately 175° C/347° F for PVC
 2. Approximately 160° C/320° F for PU
 - iv. Splice temperature difference top-bottom
 1. Approximately 10° C warmer bottom, if belt has a diamond profile (harder formulation)
 2. Approximately 10° C colder bottom, if belt has a fabric bottom to reduce bleed through
 - v. Splice dwell time: Approximately 30 seconds per 1 mm thickness (including pads), to soak heat into splice.
- e. The OPTIONS and RECIPE choices are discussed on pages 24-27.

Operation of the Aero® Press

A10

START the splice process.

- a. Prior to pushing the green START button, always check:
 - i. Are all four press connector bolts engaged?
 - ii. Are all settings correct?
- b. If yes, push the green START button and automatic splice process will start.



Cycle Start Button

A11

Automatic splice process

- a. Both internal air compressor and heating will begin.
- b. View display output screen to monitor splicing cycle progress. Screen message for different splicing stages:

NOTE: During all phases the temperature display will toggle between set value and actual.

- i. Preheat heat up (if preheat is chosen)
 1. Pressure
 2. Top temperature
 3. Bottom temperature
- ii. Preheat dwell time (if preheat is chosen)
 1. Time
 2. Top temperature
 3. Bottom temperature
- iii. Splicing heat up
 1. Pressure
 2. Top temperature
 3. Bottom temperature
- iv. Splicing dwell time
 1. Time
 2. Top temperature
 3. Bottom temperature
- v. Cool down
 1. Fans start
 2. Top temperature
 3. Bottom temperature

Operation of the Aero® Press

vi. Release Pressure

1. Pressure
2. Cycle time

WARNING: Keep fingers clear of deflected beams during splicing cycle.

STOP: If press needs to be stopped mid-cycle, depress amber stop button.



Stop Button

A12

When splice is complete, an audible noise will occur and display will indicate it is complete. Push blue button on end plate to manually release pressure. When pressure is released, display will return to main screen.

WARNING: Keep fingers clear of deflected beams while pressure deflates.

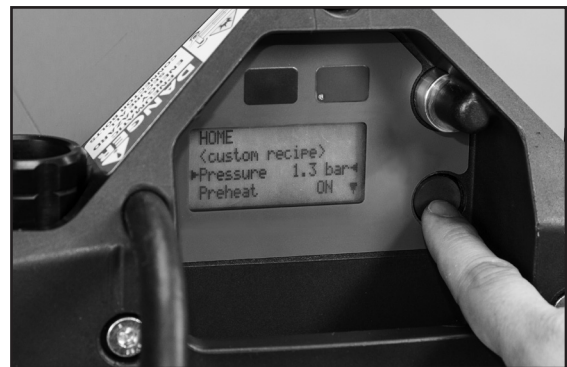

A13

Remove spliced belt from press.

- a. Disconnect umbilical cable.
- b. Loosen the four press connector bolts and rotate bolts outwards.
- c. Remove press top beam lifting vertically until beam clears clamp bar bolts. Depending upon width and weight of press, you may require assistance from another person. Do not place beam with platens facing downward, as this can cause costly platen damage.
WARNING: Platen surfaces may still be warm.
- d. Remove silicone pads and belt.

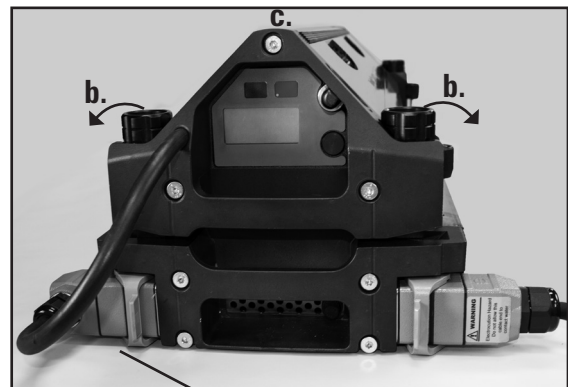

Operation of the Aero® Press

A14

Inspect splice

- a. Inspect top of splice, both in a flat and bent state. Fingers should be fully closed along entire finger, especially at the finger tips. (If not: Consider if temperature is too low.)
- b. Inspect top and bottom of splice for burn/scorch marks. (If it is: Consider if temperature too high, dwell time too long. Consider if you need to add preheat for a thick belt.)
- c. Inspect for limited but consistent “bleed through” on bottom side, if the belt has a fabric bottom cover. Edges and tips of the fingers are closed. (If not: Consider if temperature is too high, or too low.)
- d. Inspect to ensure all fingers are still in place, especially at the belt edges, with little finger shrinkage. (If not: Ensure proper use of bumpers. Consider if temperature was too high, if pressure was too high, or if dwell time was too long.)

a.

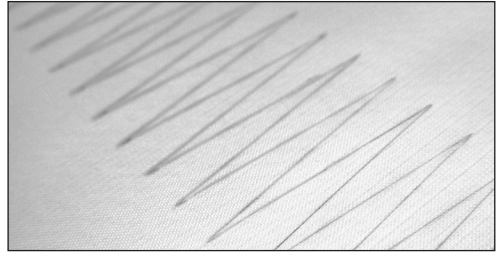

b.



c.

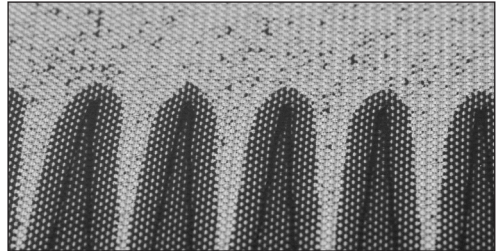

d.



A15

Instructions for use with Belt Templates

Narrow belt splicing will be completed end-to-end (across the length of the press) or in the traditional direction (across the width of the press). The belt template orientation is determined by finger geometry and belt type.

There are two versions of the Aero Splice Press for this type of splicing. If splicing in the traditional direction use 09552 AERO-325. When splicing end-to-end use 09600 AERO-325-END-BELT-CLAMPS. End belt clamps may be retrofitted to 09552 by ordering 09592 AERO-325-END-BELT-CLAMP-KIT.

Contact Customer Service at www.flexco.com to order silicone belt template pads and end belt clamp system retrofit (09592).

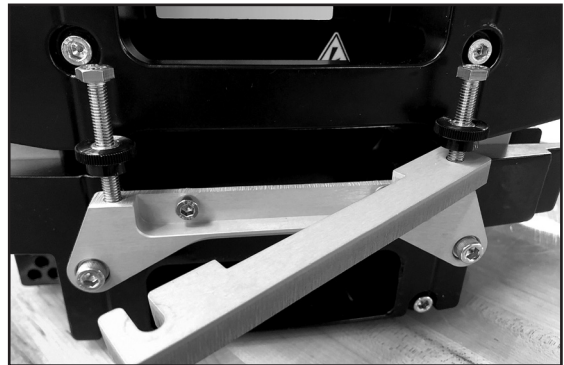

Splice Preparation for End-to-End:

- Position silicone belt template pad on bottom press beam. Belt template has corner cut outs for clamp bar studs.

NOTE: Silicone cloth is not required on bottom platen underneath the belt template.

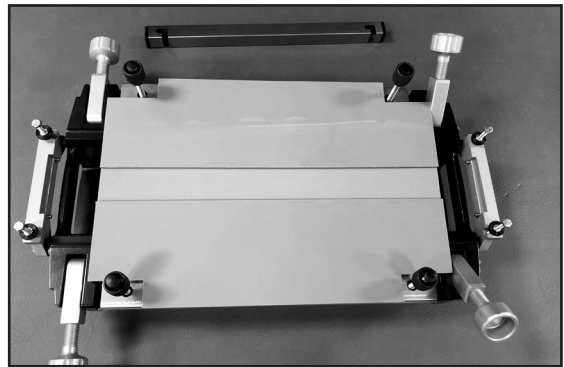

- Open both end belt clamp bars. Place finger punched belt ends in silicone channel of template. Line up fingers in center of press within channel ensuring that the finger tips are fully meshed without gaps between the fingers.



Operation of the Aero® Press

- c. While holding prepared splice in place, latch end belt clamps at press ends and tighten thumbscrews to hold belting in place.

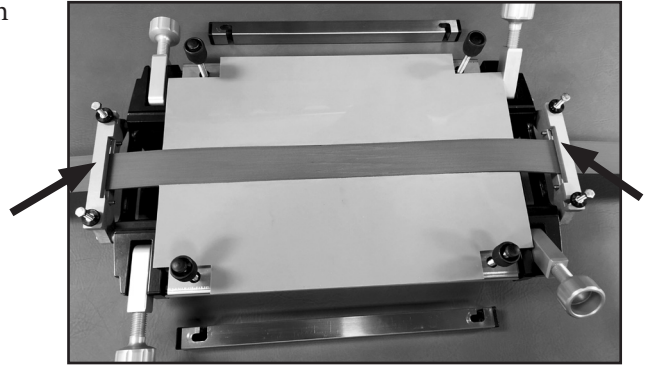

- d. Place the pressure plate over the belt ensuring the pressure plate edges line up with the prepared belt edge (no visible belt should be seen) also be sure that the pressure plate ends fit into the cutouts of both end belt clamps. Once the pressure plate and belt are aligned, install clamp bars the length of the press to ensure the belt template and prepared splice stay in place for an optimal quality splice. Remove the pressure plate.

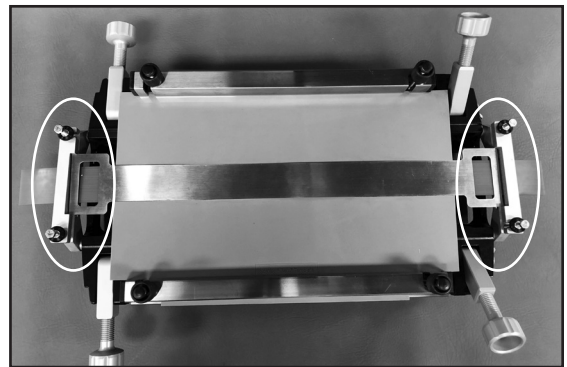

- e. Place silicon cloth over top of prepared belt the length of the press.
Note: silicone spray is not needed.

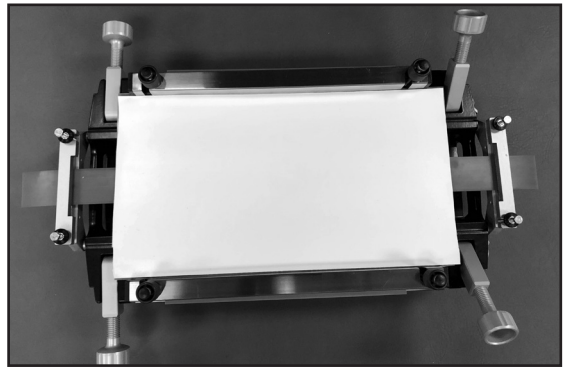

- f. Place pressure plate provided with belt template over prepared splice.

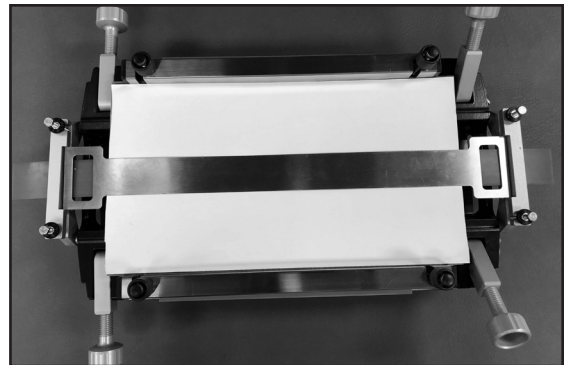

Operation of the Aero® Press

- g. Place top press beam on top of prepared belt and hand tighten all four press connector bolts.

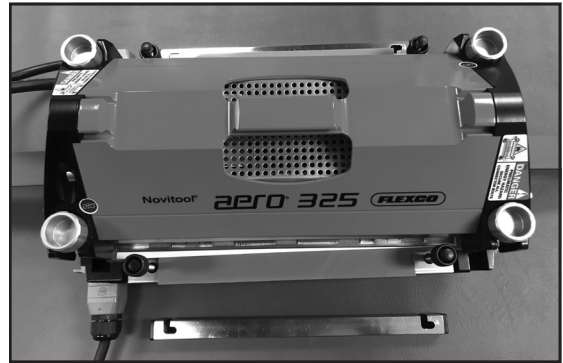

- h. Proceed with Aero press operation instructions starting with section A5 page 15.

- i. Inspect splice

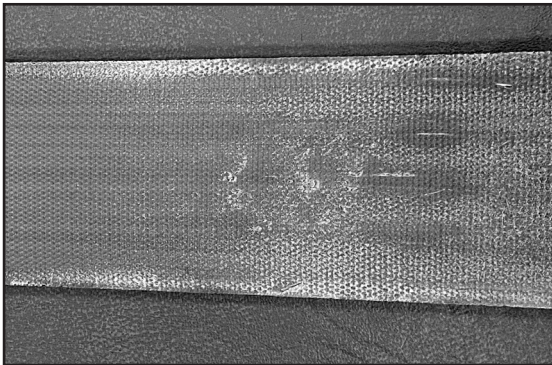

Not enough pressure - bottom

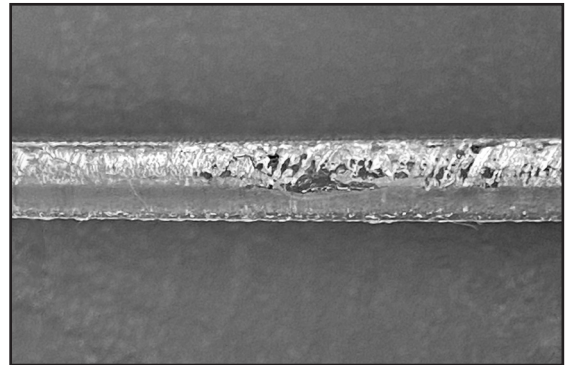

Not enough pressure - edge

- Not enough pressure. For 45 mm belt with thickness less than 4.25 mm use 2 pressure plates.
- Ensure pressure plate fully covers belt in channel. Review step d.

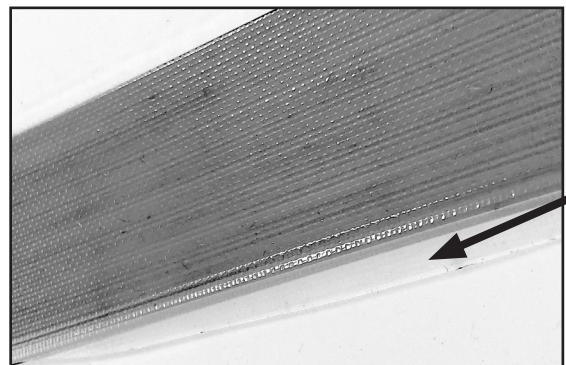

Pressure plate not over belt - overflow

Operation of the Aero® Press

Splice Preparation for Traditional Direction (Across width of Platen):

- a. Position silicone belt template pad on bottom press beam. Belt template has corner cut outs for clamp bar studs.

NOTE: Silicone cloth is not required on bottom platen underneath belt template.

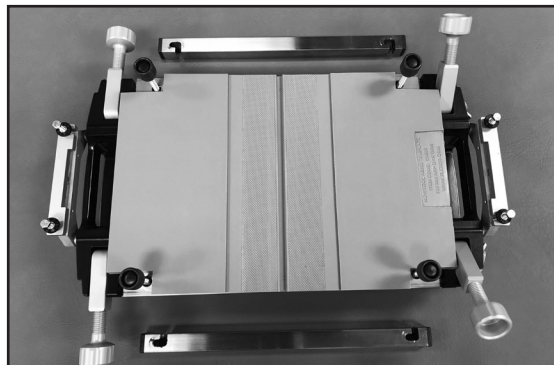

- b. Place finger punched belt ends in silicone channel of template. Line up fingers in center of press within the heat zone ensuring that the finger tips are fully meshed without gaps between the fingers.

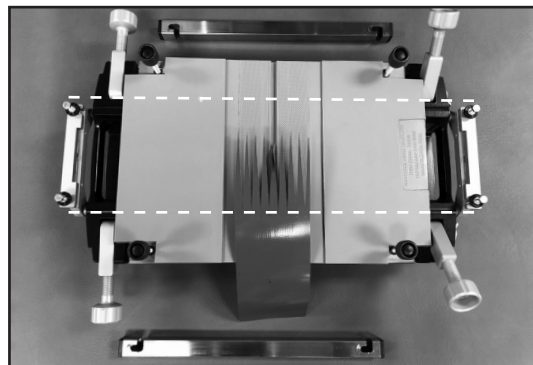

- c. Place metal shims firmly against both edges of the belt. While holding prepared splice in place, install clamp bars across length of press. The clamp bars hold the belt template, prepared belt, and shims in place.

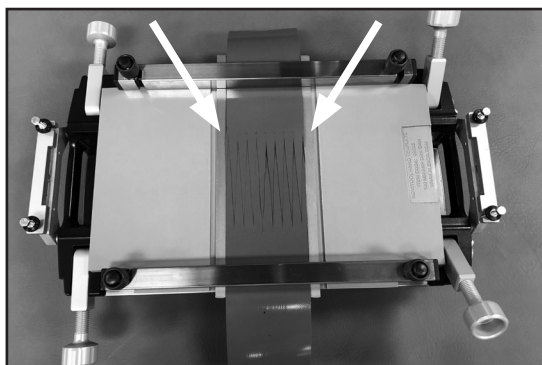

Operation of the Aero® Press

d. Place silicon cloth over top of prepared belt the length of the press.

Note: silicone spray is not needed.

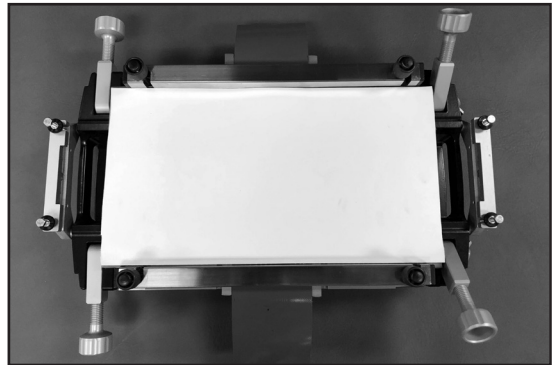

e. Place top press beam on top of prepared belt and hand tighten all four press connector bolts.

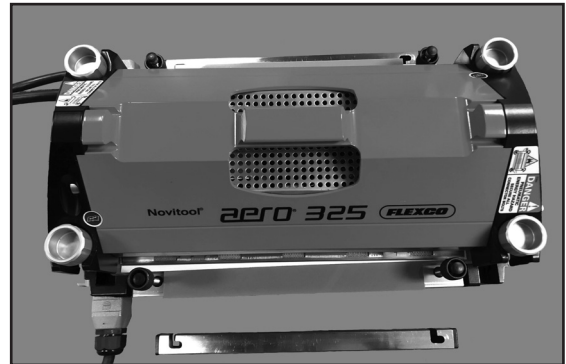

f. Proceed with Aero press operation instructions starting with section A5 page 15.

Contact Flexco at www.flexco.com for additional belt template options.

Options

Within the Options menu the following settings are available:

- a) Temperature (C/F)
- b) Pressure (bar/psi)
- c) Sound (on/off)
- d) Date/Time
- e) Languages
- f) Import Recipes
- g) Restore Recipes
- h) Clear All Recipes
- i) Export Recipes
- j) Export Data Log
- k) Administration Menu
- l) Back to HOME

To access these options, scroll to the appropriate text and depress the button. To return to the main menu, scroll to the bottom text and select 'Back to HOME'.

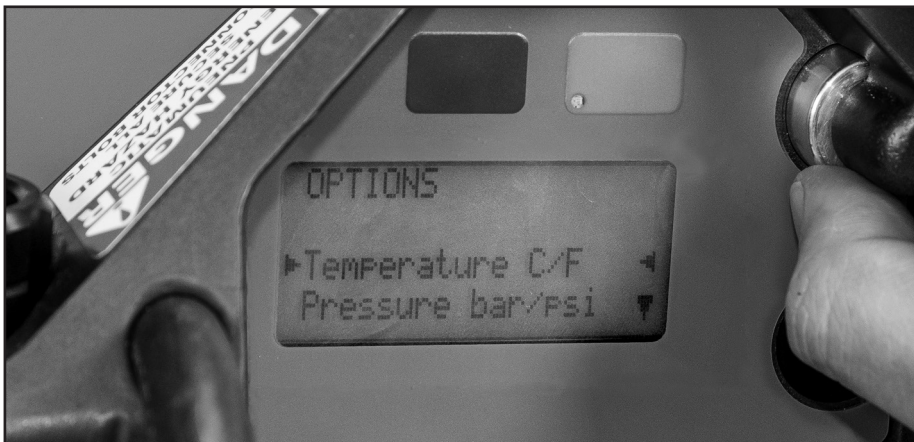

Recipes

Visit www.flexco.com for detailed instructions and Recipe Management Tool updates.

C1

Aero® Recipes

The Aero is capable of storing recipes for future use. Recipes are stored in ‘Groups’, which allow you to organize your splice recipes.

- **Group 0 Recipes:** Up to 99 recipes can be manually input into the press using the selector knob. The next available recipe number will automatically be assigned. Group 0 recipes are editable on the press only.
- **Groups 1-10:** Using the Aero Recipe Management Tool, you can enter up to 99 recipes per group on a computer, save the files on the USB flash drive, and load the recipes into your press. Group 0 and Group 1-10 recipes can be downloaded from the press onto a USB flash drive.

C2

Saving Recipes at the Press

- Scroll down display list with selector knob and select “Store Recipe” by depressing selector knob.
- Enter a “Recipe Name” with a maximum of 15 alphanumeric characters. Depress selector knob and select “SEL” becomes edit “EDIT”. Rotate selector knob to letters/numbers for naming. Depress selector knob to save character. Rotate knob to the right to the next field to continue with naming of recipe. When naming complete, scroll to right to move arrows to bottom line of display. With arrows pointing to “Done” depress selector knob.
- “Save Custom Recipe” select “Cancel” or “Confirm”. Select “Confirm” and recipe is saved and recipe name appears with splice settings.



C3

Saving Recipes on Aero® Recipe Management Tool

1. Insert USB flash drive in external computer.
2. Create a file folder to hold the Aero Recipe Management Tool. This will be the same location that the .csv file that is created for transport to your press will be saved.
3. Open the ARMTx.x.xlsm file.
4. Instructions for inputting or modifying recipes will be contained within the Aero Recipe Management Tool, including how to export the files to transport via the USB flash drive to the Aero press.

There are ten (10) folders available for off-line recipe storage: Group 1 – 10. Up to 99 recipes may be stored for each group. Recipes in Group 1 – 10 are editable on an external computer, but not at the press. If a recipe from Group 1 – 10 is edited at the press, it may be saved to Group 0.

When changes are made at an external computer to Group 1 – 10 and then loaded to press, it updates all Group 1-10 recipes.

C4

Loading Recipes from Aero® Recipe Management Tool

- a. Follow instructions on powering up the press, then insert USB flash drive into the USB port in the top of the press.
- b. Display reads USB Device Detected with options to select “Export Data Log”, “Import Recipes”, “Export Recipes”, and “Back”. Scroll to “Import Recipes” and depress selector knob. Select “Cancel or Confirm.” If “Cancel” is selected, it will return to Options menu. If “Confirm” is selected, the display states “Processing”.



Recipes

- c. Once complete display reads “Import complete”. Select “Return” or “Undo”. “Return” brings you back to “Options0 where you can scroll down to “Back to Home”. At end of updating recipes the USB flash drive may be removed.

“Undo” allows you to remove the USB flash drive without making recipe updates.

In addition to internal recipes, third parties, like conveyor belt manufactures might develop splice recipes for their range of belts. These external recipes can in imported into the Aero Recipe Management Tool.

If you have multiple presses at your facilities, you can load Group 1-10 recipes on multiple presses.

C5

Loading a Saved Recipe

- a. Scroll down display list and select “Load Recipe”, depress selector knob.
- b. “Select Group” from created groups 0 Custom or 1-10. 0 Custom are recipes that have been generated and stored directly on the press. “Select Recipe” by number and name. Recipe is loaded.

NOTE: If a recipe is deleted then the number of other stored recipes changes based on next number. Therefore, in internal documentation it is better to reference the name of the recipe than the number, as numbers can change.

If select “Cancel”, it will bring you back to last used recipe.

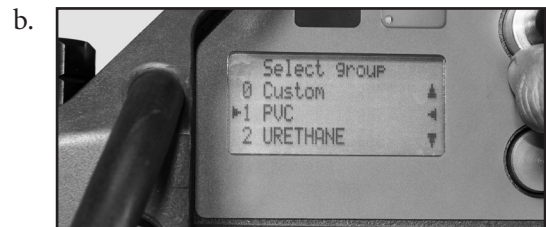

Technical Assistance

Contact Flexco's Customer Service if technical assistance or repair is needed: www.flexco.com

Aero[®] Press End Plate Removal and Reassembly

E1 Tools to Service Press

- 2 mm hex key
- 6 mm hex key
- 7 mm crescent wrench
- Aero[®] splice press instruction manual

E2 End Plate Removal to Access Electrical Tray

Both top and bottom press beams contain an electrical tray with all electrical and pneumatic components. Prior to accessing electrical trays unplug all power cables (power switch alone is not sufficient). Procedure to remove electrical trays are as follows:

Top Beam End Plate Removal To Access Electrical Tray:

1. Locate rear top end plate (end without display screen). Using 6 mm hex key, unscrew 3 bolts located on rear top end plate.

Pull away from extrusion.

2. Disconnect ground wires from end plate.
Remove end plate.



End Plate Removal and Reassembly

3. Disconnect by pulling three connectors straight out inside top beam of press.

NOTE: pull on connectors not wires themselves:

- a. Heater connector (gray): 2 white wires and 1 red wire

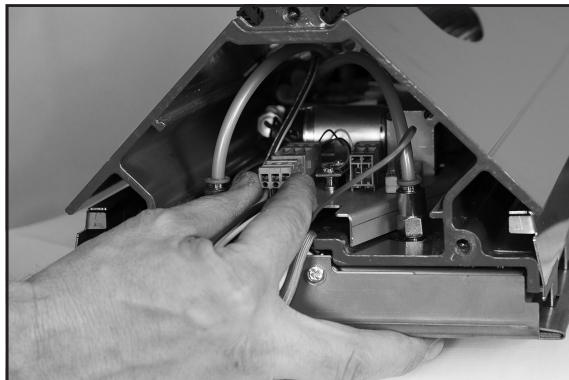

- b. Thermal fuse connector (gray): white wire

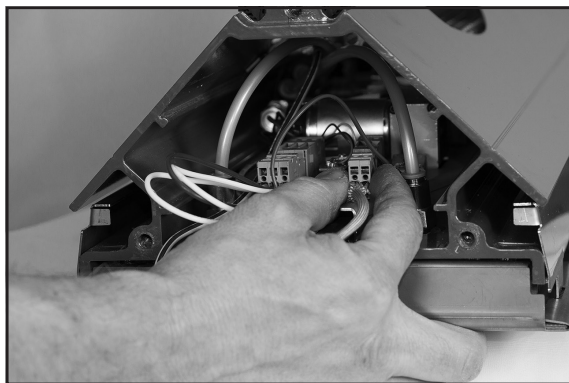

- c. Thermocouple connector (yellow):
2 mm hex key may be used to assist in removal

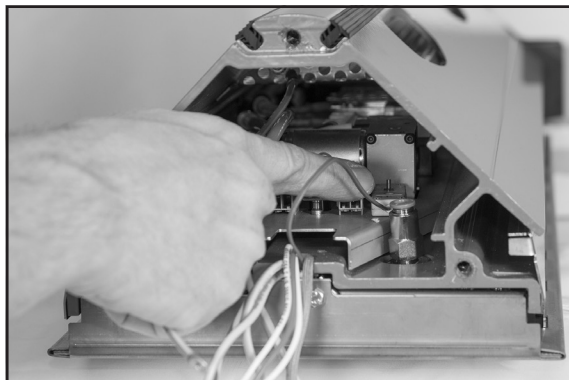

End Plate Removal and Reassembly

4. Disconnect the 2 pneumatic connections. Hold down blue ring of connector and pull hose out.

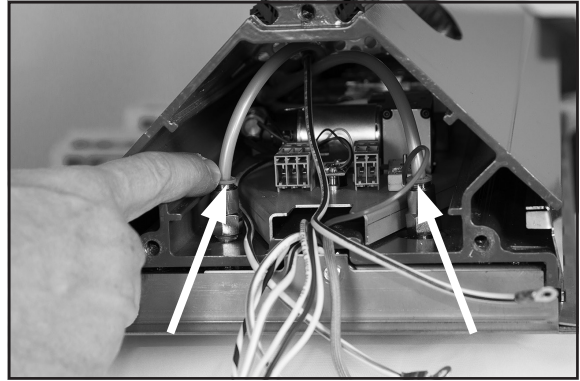

5. Using 6 mm hex key, unscrew 3 screws located on front end plate.



Ensure wires are free to move and not tangled. Then gently pull top end plate to slide electrical tray out of beam.

End Plate Removal and Reassembly

Bottom Beam End Plate Removal to Access Electrical Tray:

1. Locate rear end plate (end without electrical connectors). Using a 6 mm hex key, unscrew 4 screws located on rear bottom end plate.
Pull away from extrusion.

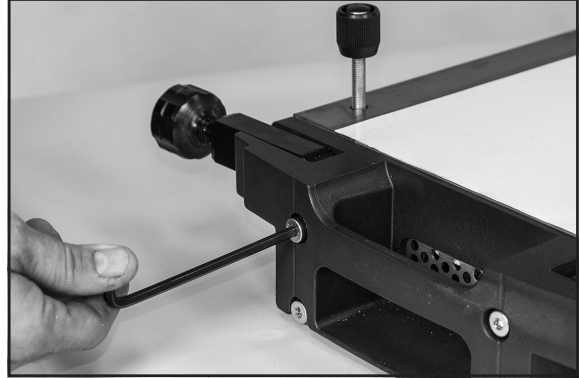

2. Disconnect ground wires from end plate.
Remove end plate.

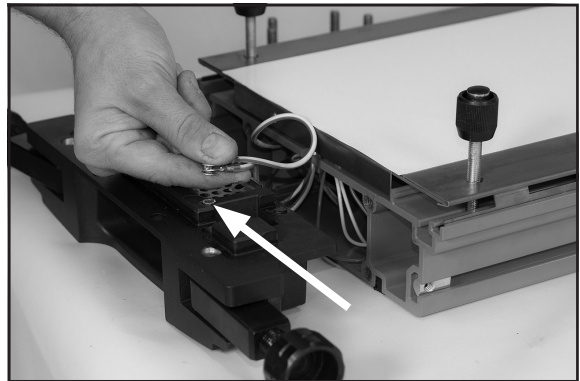

3. Disconnect by pulling three connectors straight out inside top beam of press.
NOTE: pull on connectors not wires themselves:
 - a. Heater connector (gray): 2 white wires and 1 red wire



End Plate Removal and Reassembly

- b. Thermal fuse connector (gray): white wire

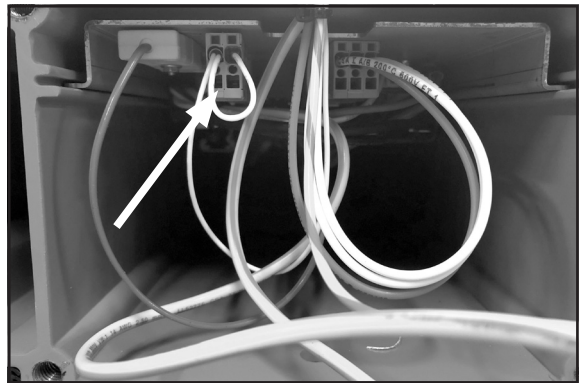

- c. Thermocouple connector (yellow): 2 mm hex key may be used to assist in removal

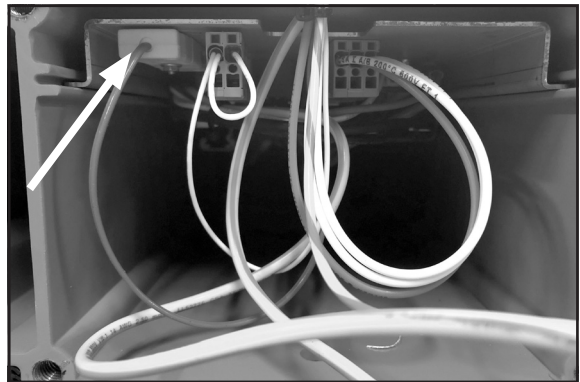

4. Using 6 mm hex key unscrew 4 screws located on front end plate.

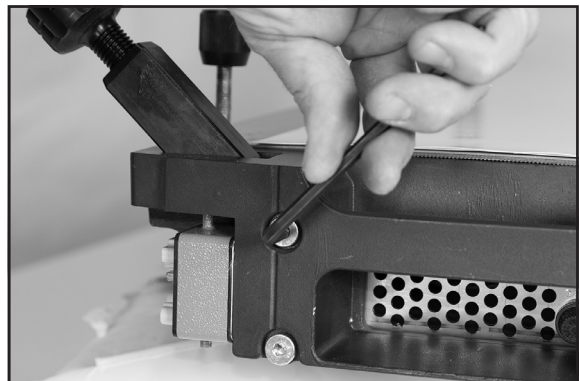

Ensure wires are free to move and not tangled. Then gently pull top end plate to slide electrical tray out of beam.

End Plate Removal and Reassembly

E3 Electrical Tray Contents Top Beam Electrical Tray Contents:

- A. Umbilical cable
- B. Main controller with display and control knob
- C. Press release valve
- D. USB connector
- E. Cooling fans
- F. Compressor
- G. Thermal fuse relay
- H. Power control PCB
- I. Solid state relay
- J. S/P relay

Aero® 625 Top Beam Electrical Tray

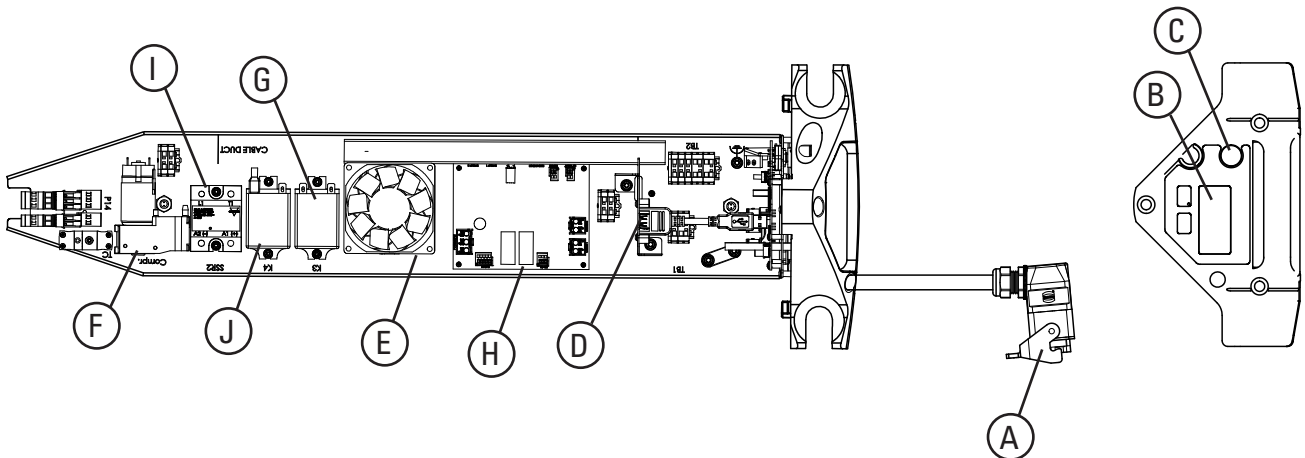

Aero® 1525 Top Beam Electrical Tray

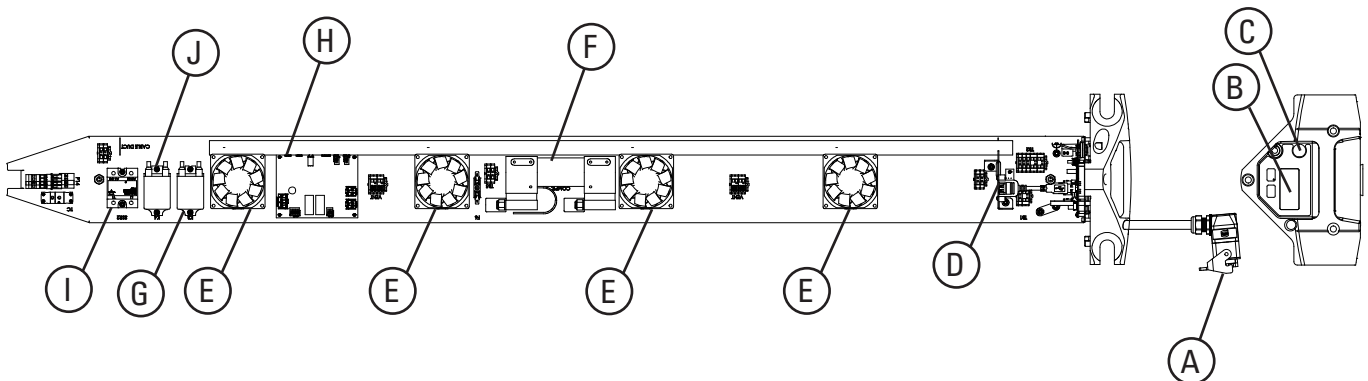

End Plate Removal and Reassembly

Bottom Beam Electrical Tray Contents:

- | | |
|-------------------------------|-------------------------|
| A. Power connection | F. Power controller PCB |
| B. Umbilical cable connection | G. Solid state relay |
| C. Cooling fans | H. S/P relay |
| D. 24VDC power supply | I. Buzzer |
| E. Thermal fuse relay | J. Fuses |

Aero® 625 Bottom Beam Electrical Tray

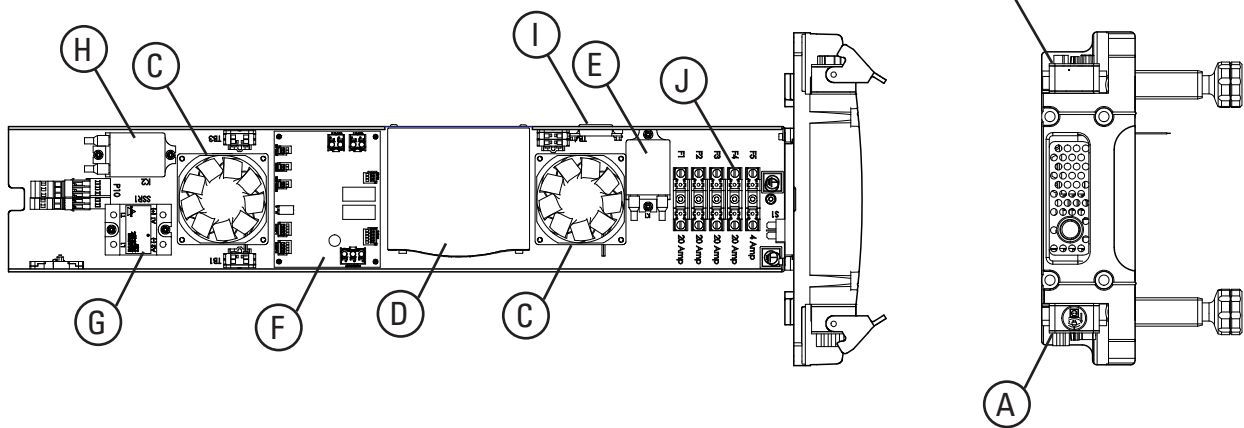

Aero® 1525 Bottom Beam Electrical Tray

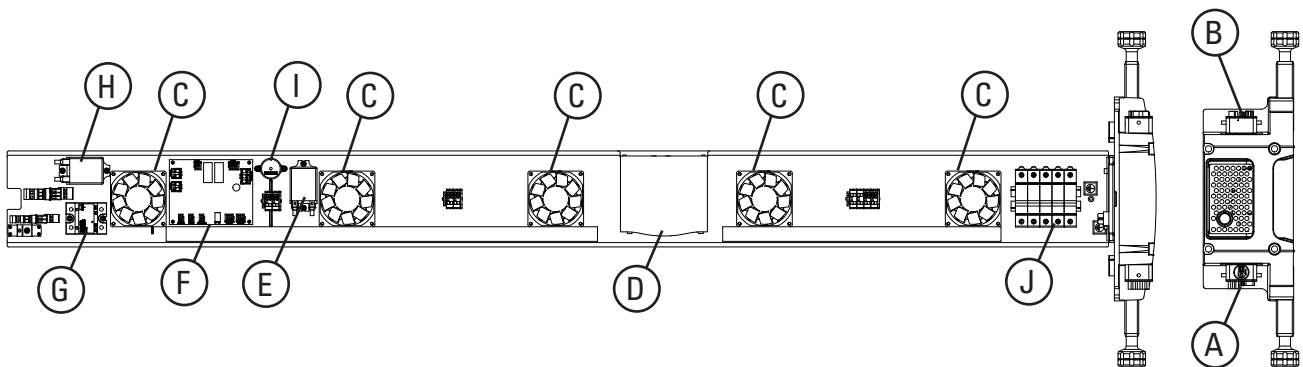

E4

Reassembly of End Plates

Top Beam End Plate Reassembly:

1. Gently slide electrical tray into beam ensuring wires are free to move and not tangled and that there is no binding. The tray should slide in with no resistance and the end plate should fit flush to the extrusion. If there is resistance, check to make sure wires are not catching.

2. Using 6 mm hex key, screw 3 screws located on front of end plate starting with the two lower screws and finalizing with the top screw.



3. At rear of press re-connect the 2 pneumatic connections. Press hose into quick connect fitting.

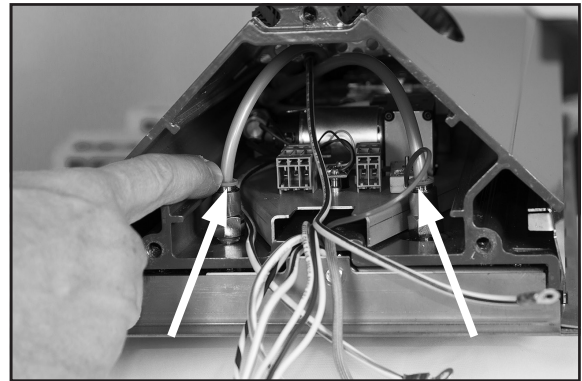

End Plate Removal and Reassembly

4. Reconnect three connectors inside top beam of press:

- a. Heater connector (gray): 2 white wires and 1 red wire

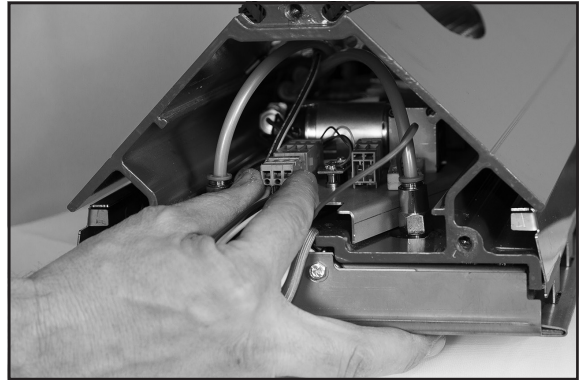

- b. Thermal fuse connector (gray): white wire

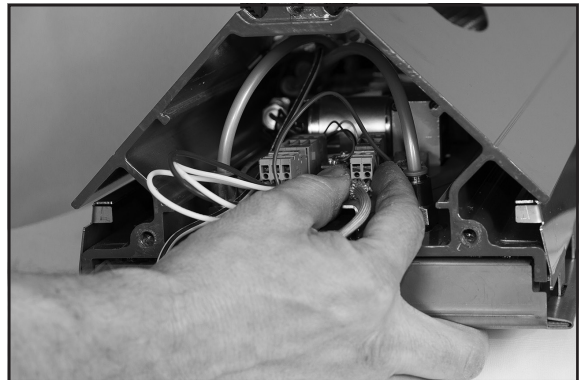

- c. Thermocouple connector (yellow): brown wire.
Match prongs to same size slot (typically + and - up).

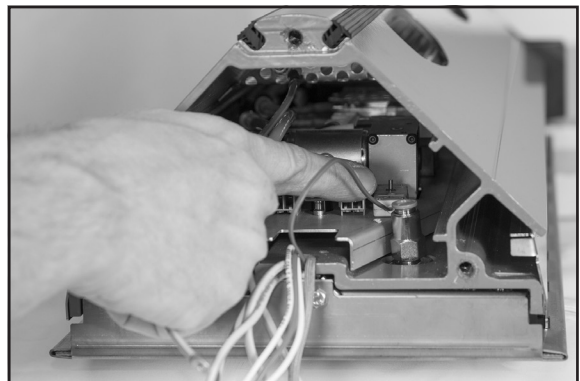

End Plate Removal and Reassembly

5. Reconnect ground wires to end plate ensuring wires are oriented to fit within the extrusion profile.

Position head plate flush with the extrusion. Place wires within slot at end of extrusion to ensure that the wires aren't pinched between the beam and the head plate. If there is resistance a wire may be pinched and must be adjusted.



6. Using 6 mm hex key, screw the rear top end plate starting with the two lower screws and finalizing with the top screw.



End Plate Removal and Reassembly

Bottom Beam End Plate Reassembly:

1. Gently slide electrical tray into beam ensuring wires are free to move and not tangled and that there is no binding. The tray should slide in with no resistance and the end plate should fit flush to the extrusion. If there is resistance, check to make sure wires are not catching. Check the bottom of the press to ensure that the air intake perforated plate is not showing.

2. Using 6 mm hex key, screw 4 screws located on front of end plate.

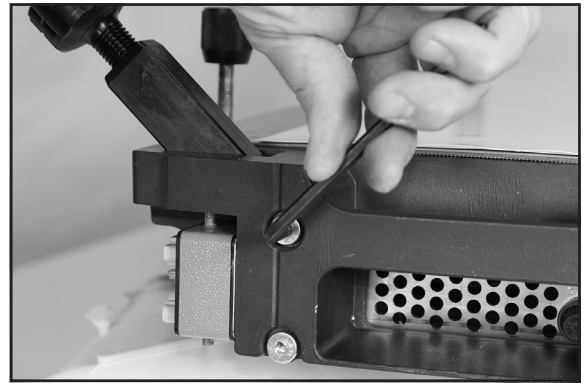

3. Reconnect three connectors inside bottom beam of press:

a. Heater connector (gray): 2 white wires and 1 red wire



b. Thermal fuse connector (gray): white wire

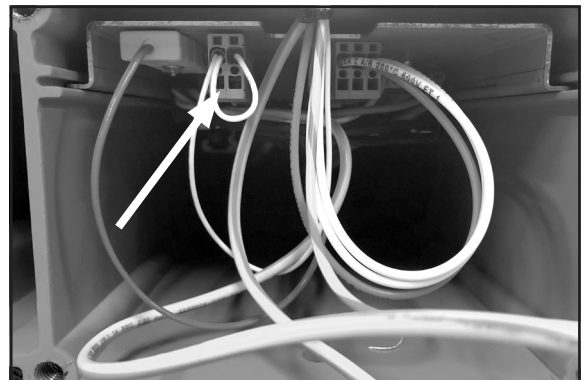

End Plate Removal and Reassembly

- c. Thermocouple connector (yellow); brown wire

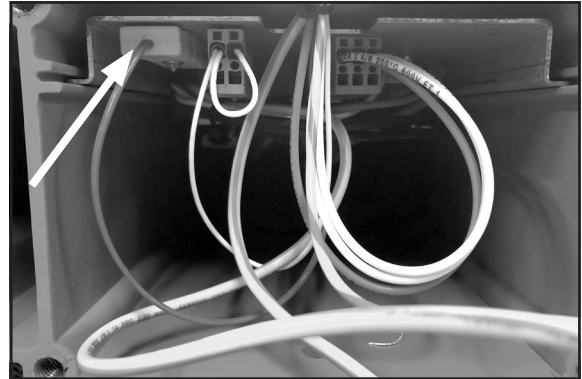

4. Reconnect ground wires to end plate ensuring wires are oriented to fit within the extrusion profile.
Position head plate flush with the extrusion. Place wires within slot at end of extrusion to ensure that the wires aren't pinched between the beam and the head plate. If there is resistance a wire may be pinched and must be adjusted.

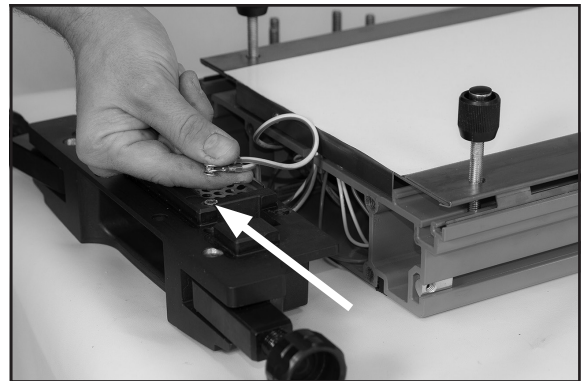

5. Using 6 mm hex key, screw 4 screws located on rear bottom end plate.

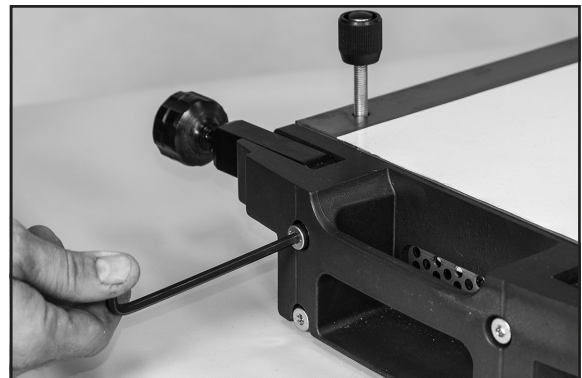

Electrical Diagrams of the Power Supply Cables - Single Phase

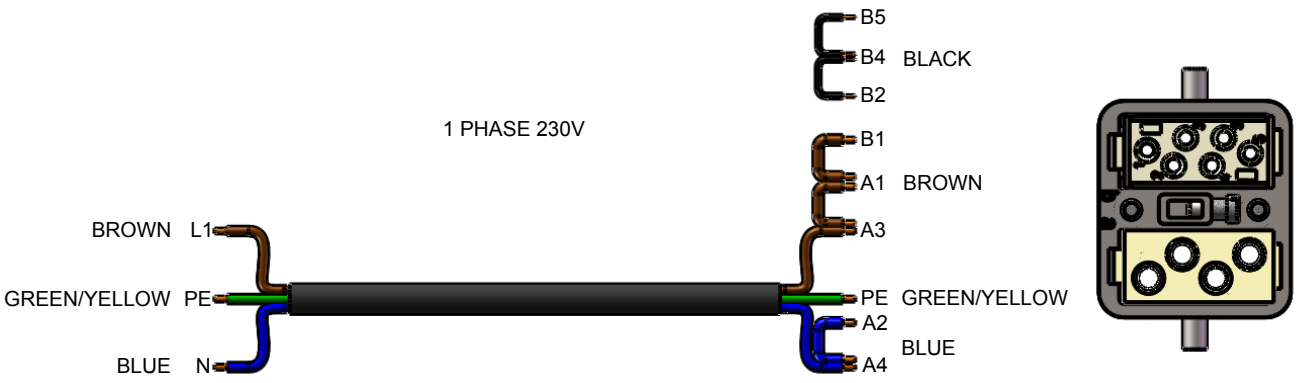
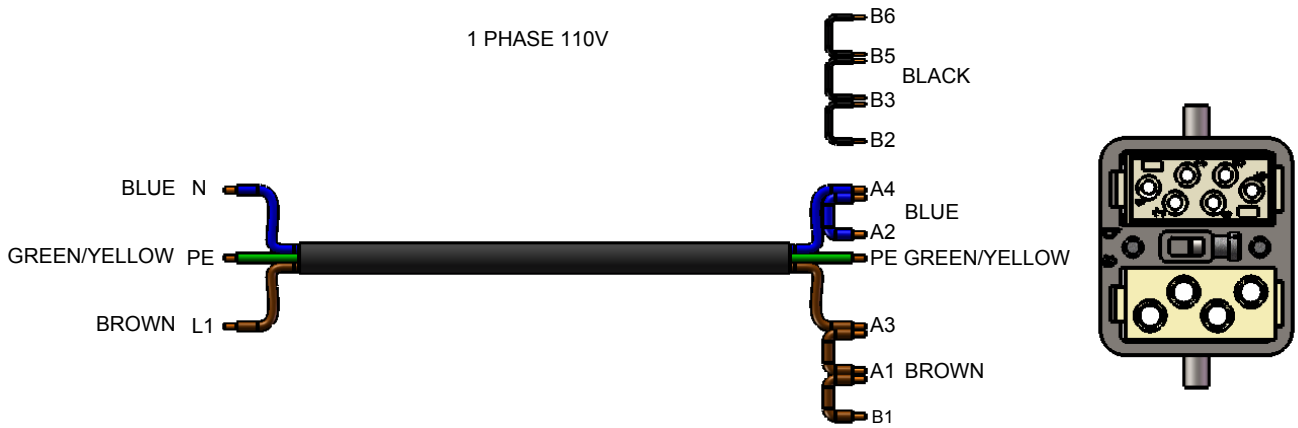

Electrical Diagrams of the Power Supply Cables - 3 Phase

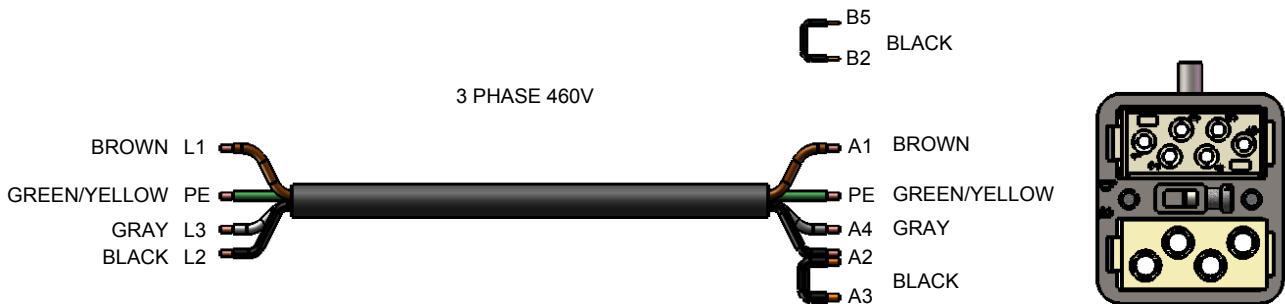
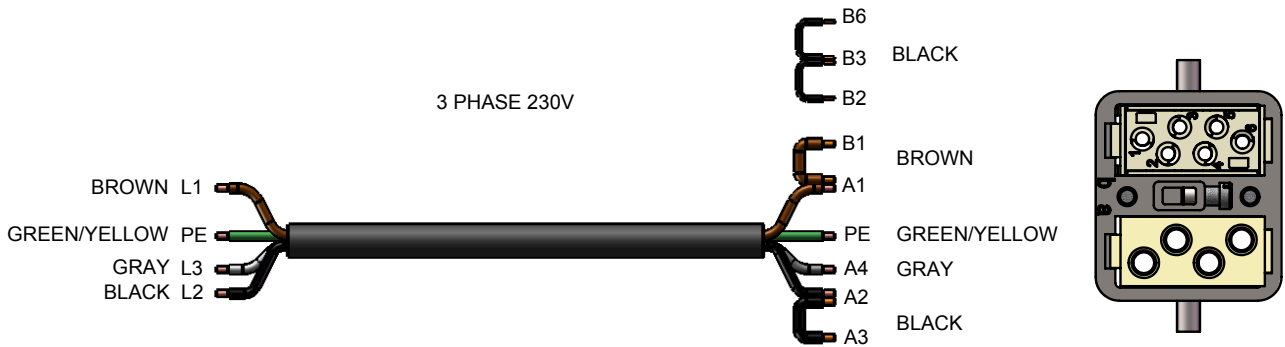

Schematics

Schematics Main Controller 325, 25, 925, 1225, 1525, 1835, 2135

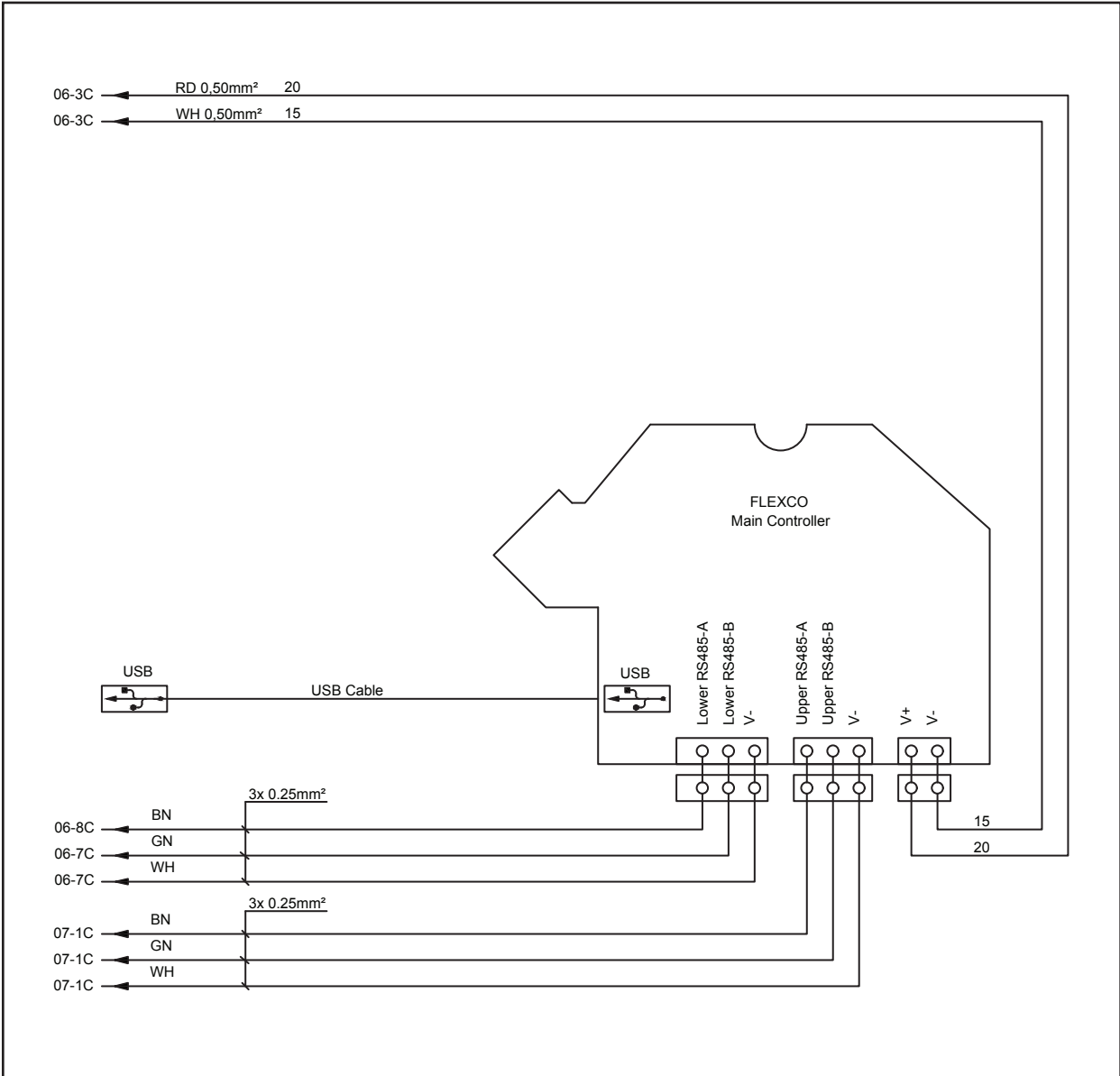

Schematics

Schematics Lower Press 325

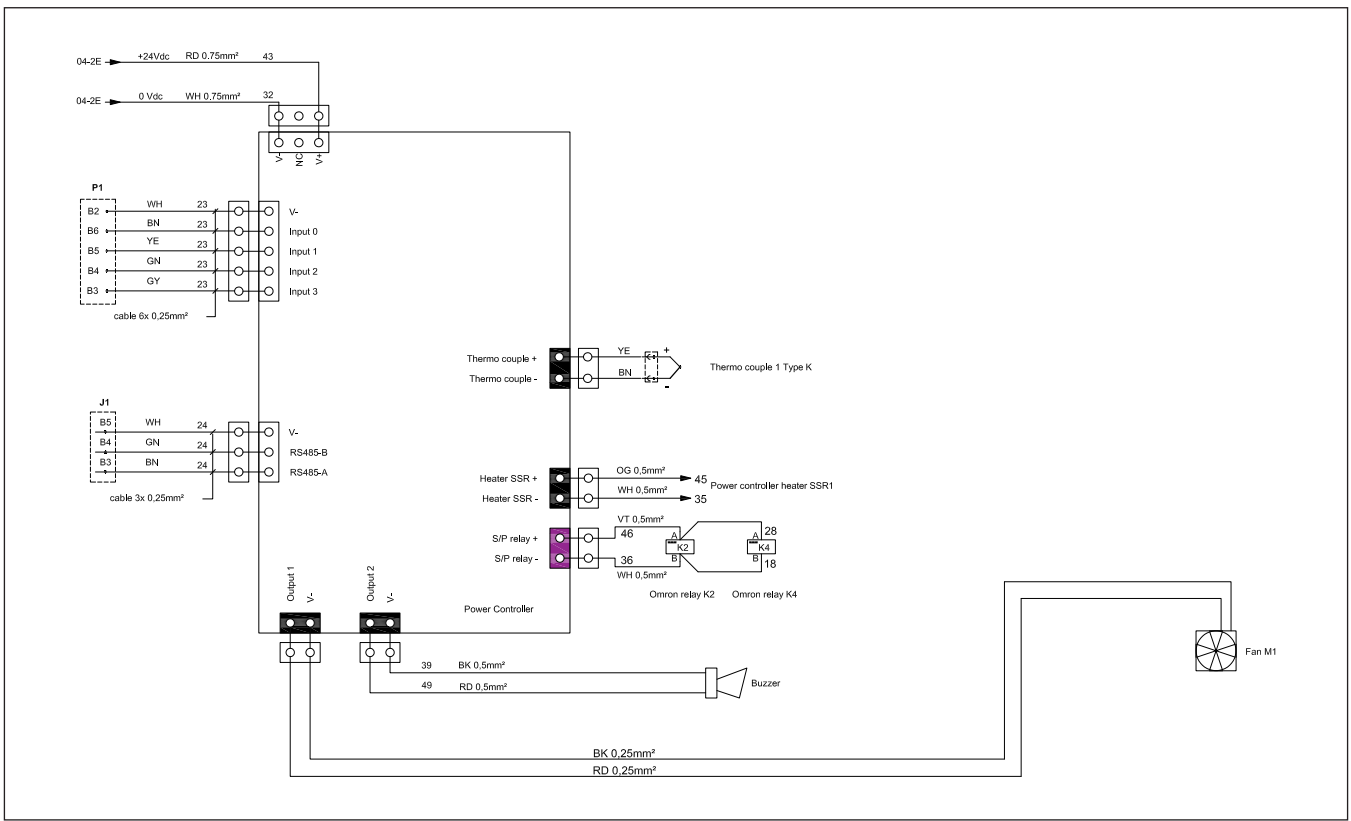
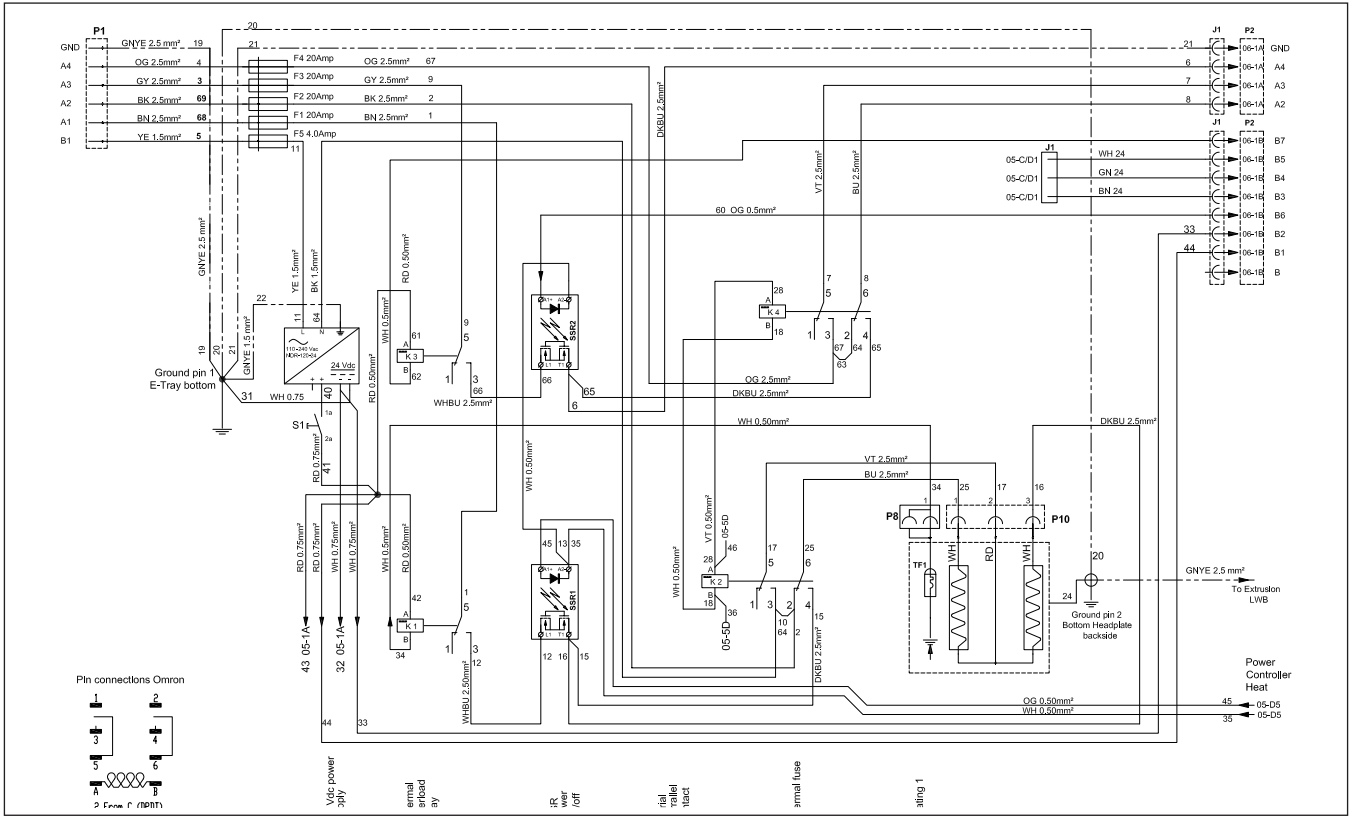

Schematics

Schematics Lower Press 325

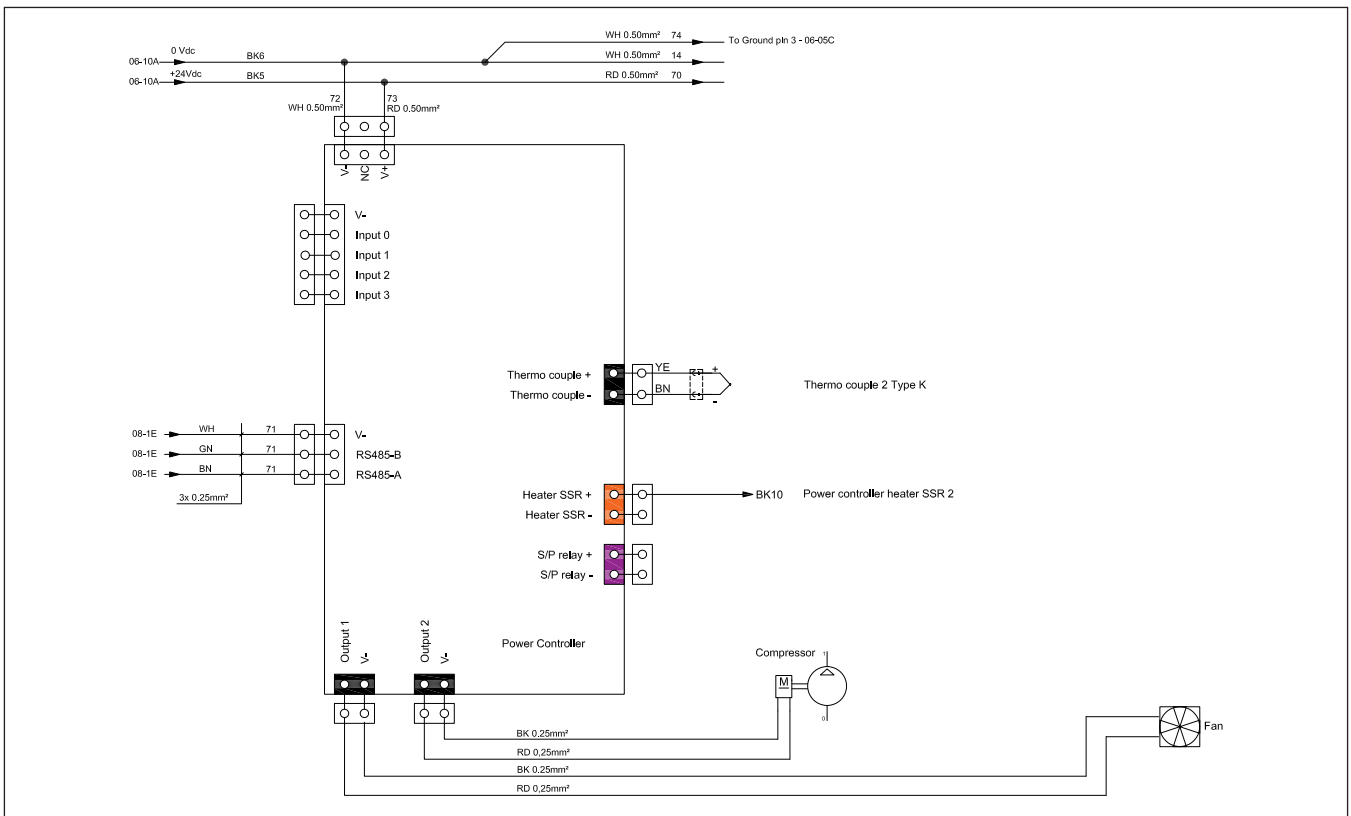
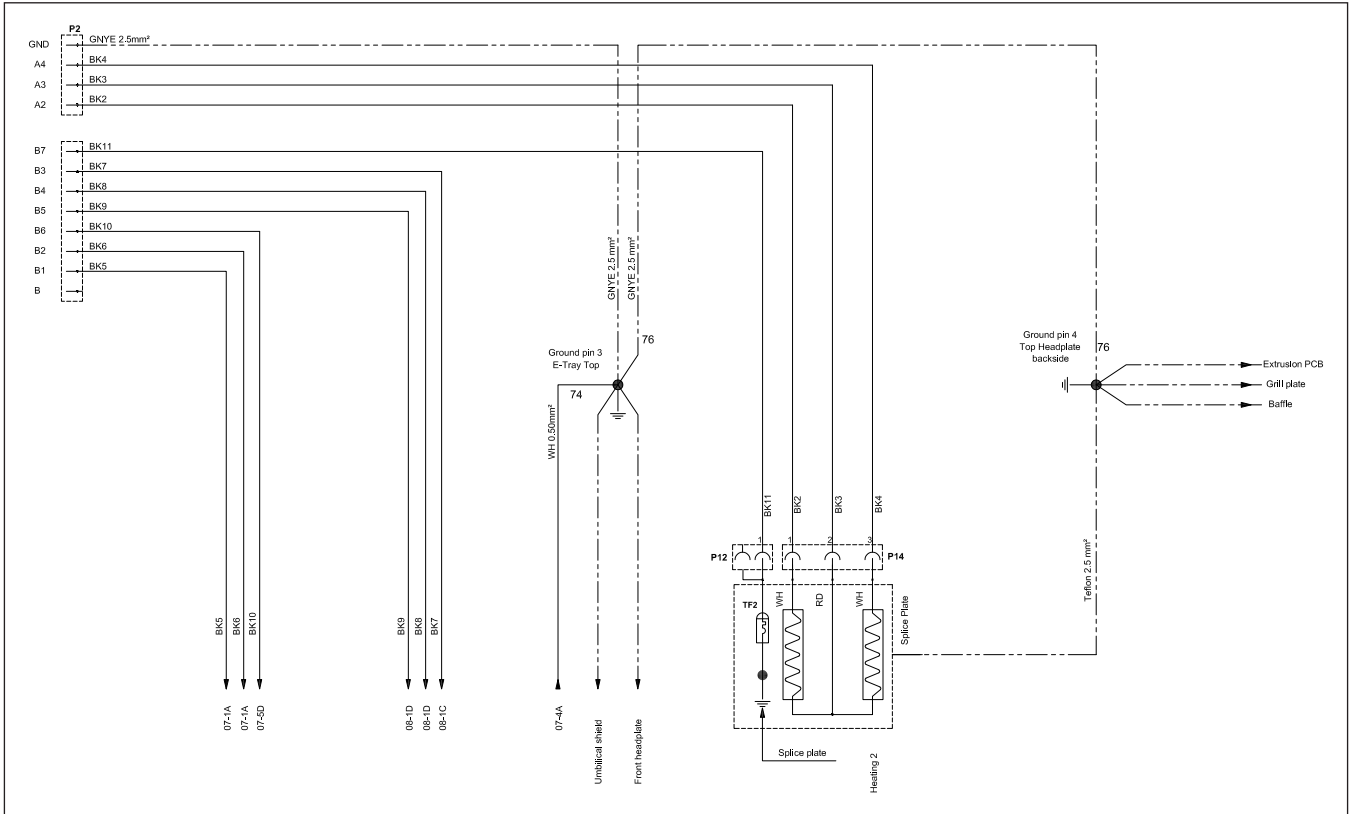

Schematics

Schematics Lower Press 625

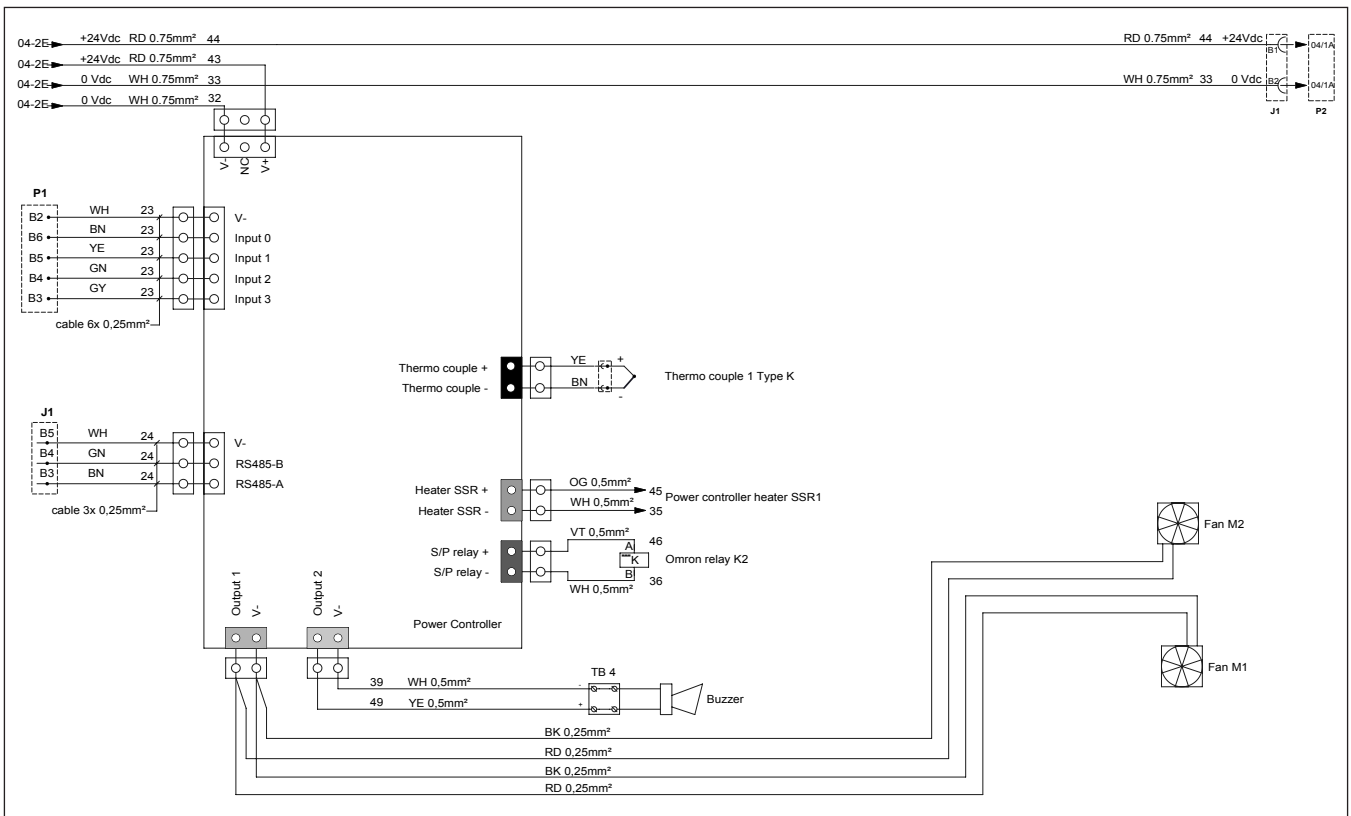
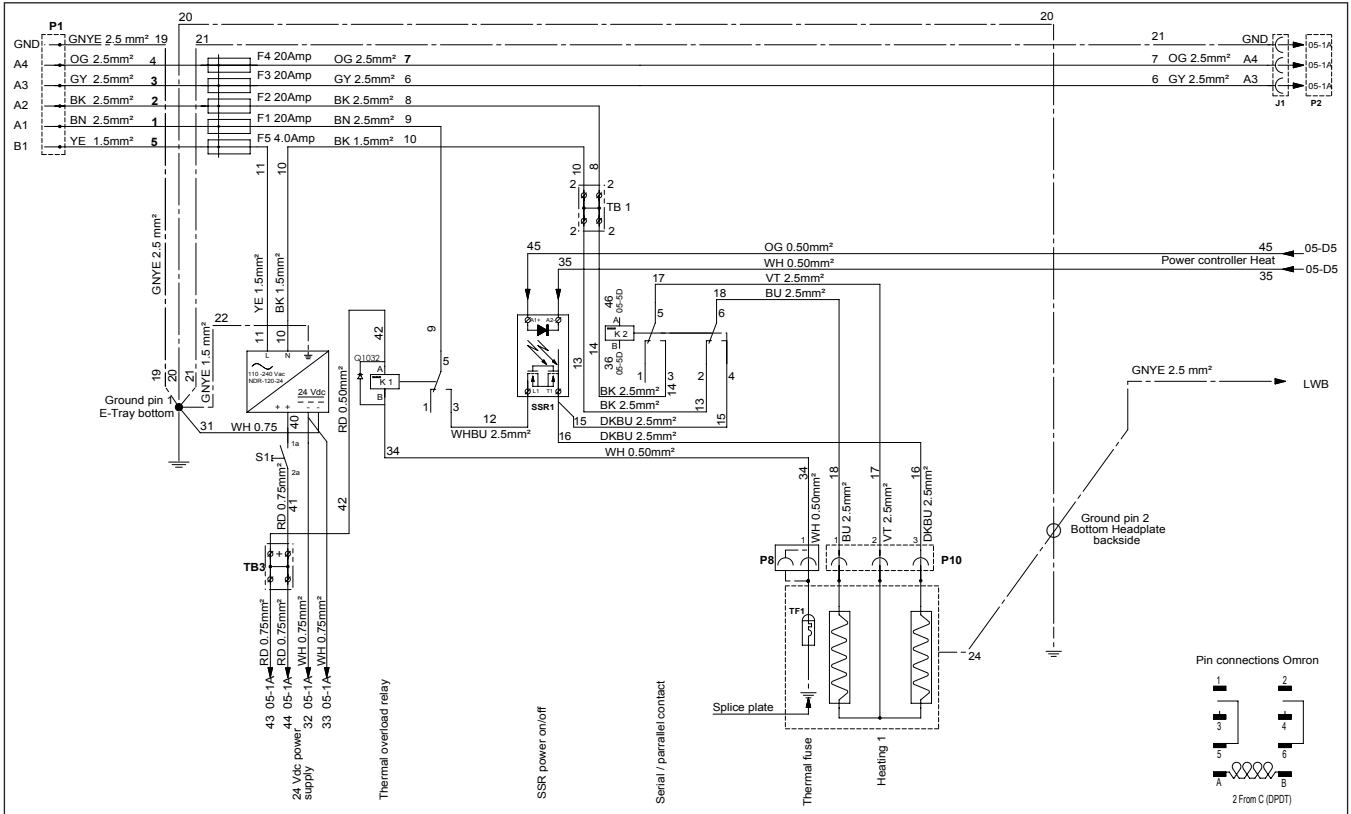

Schematics

Schematics Upper Press 625

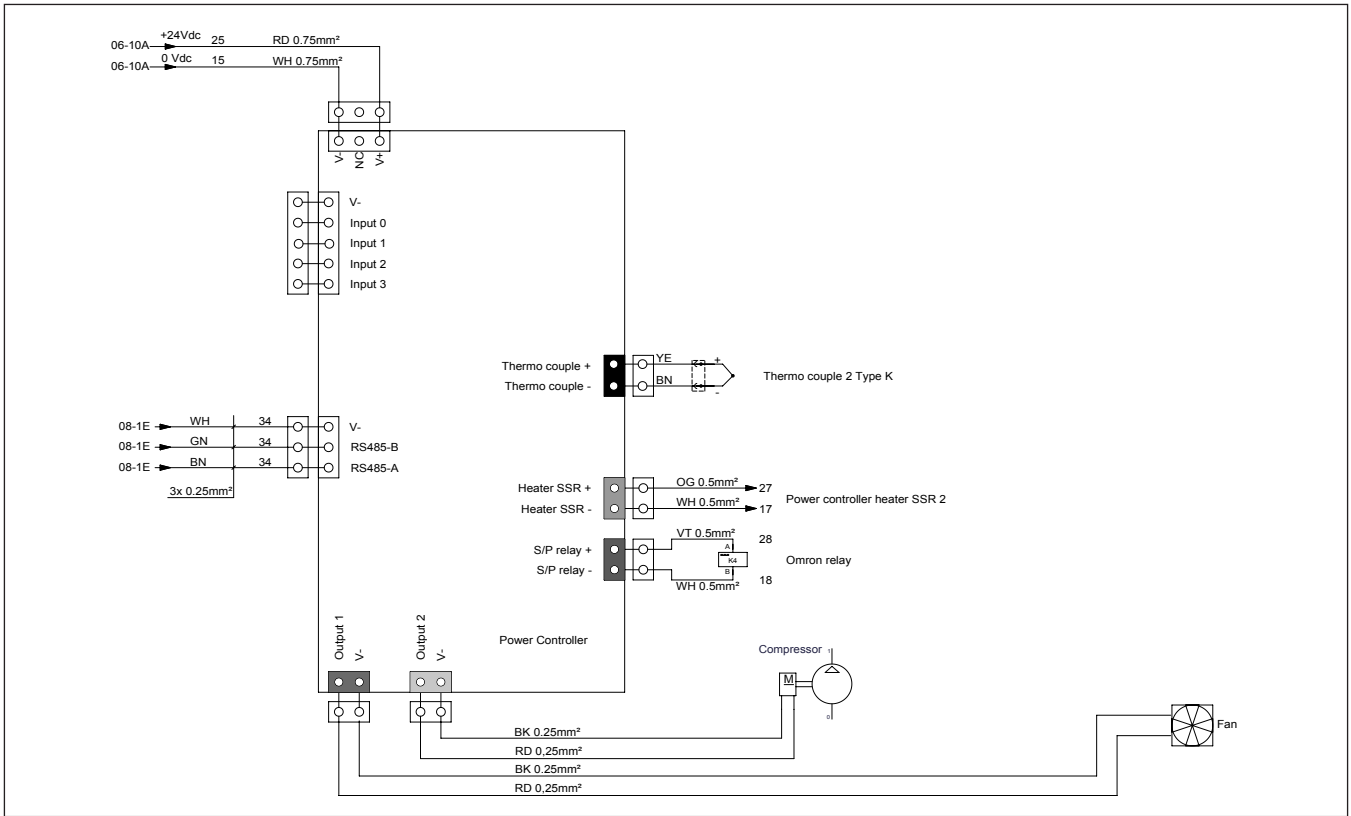
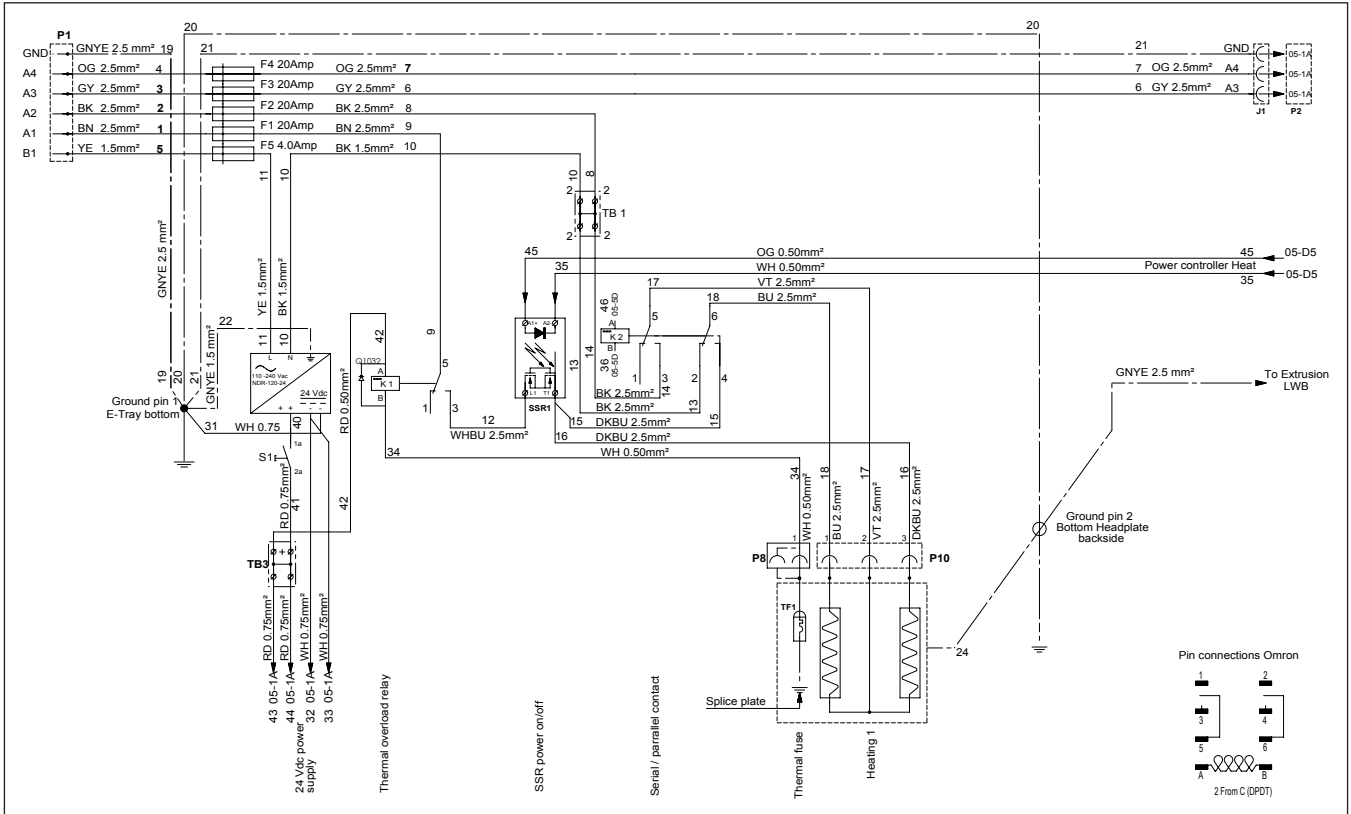

Schematics

Schematics Lower Press 925

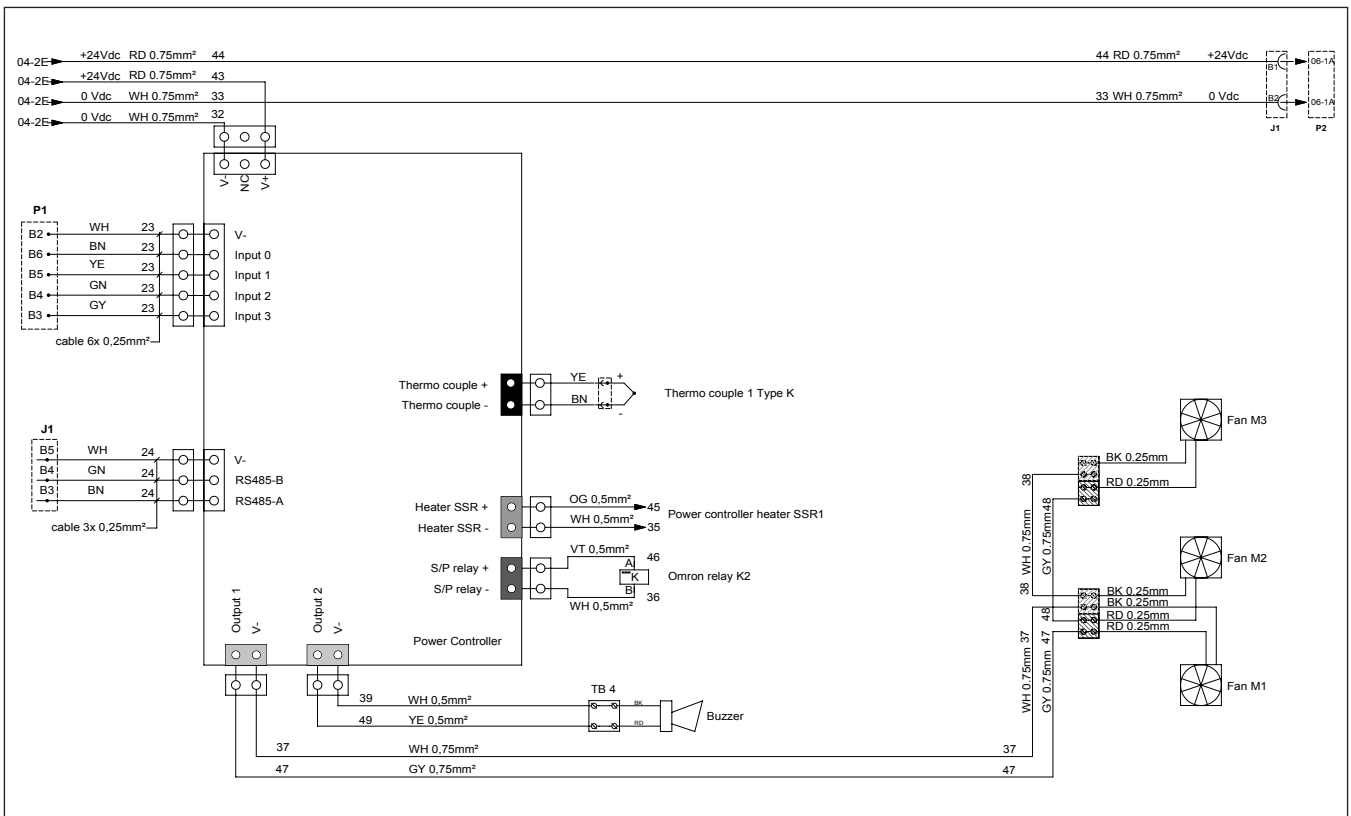
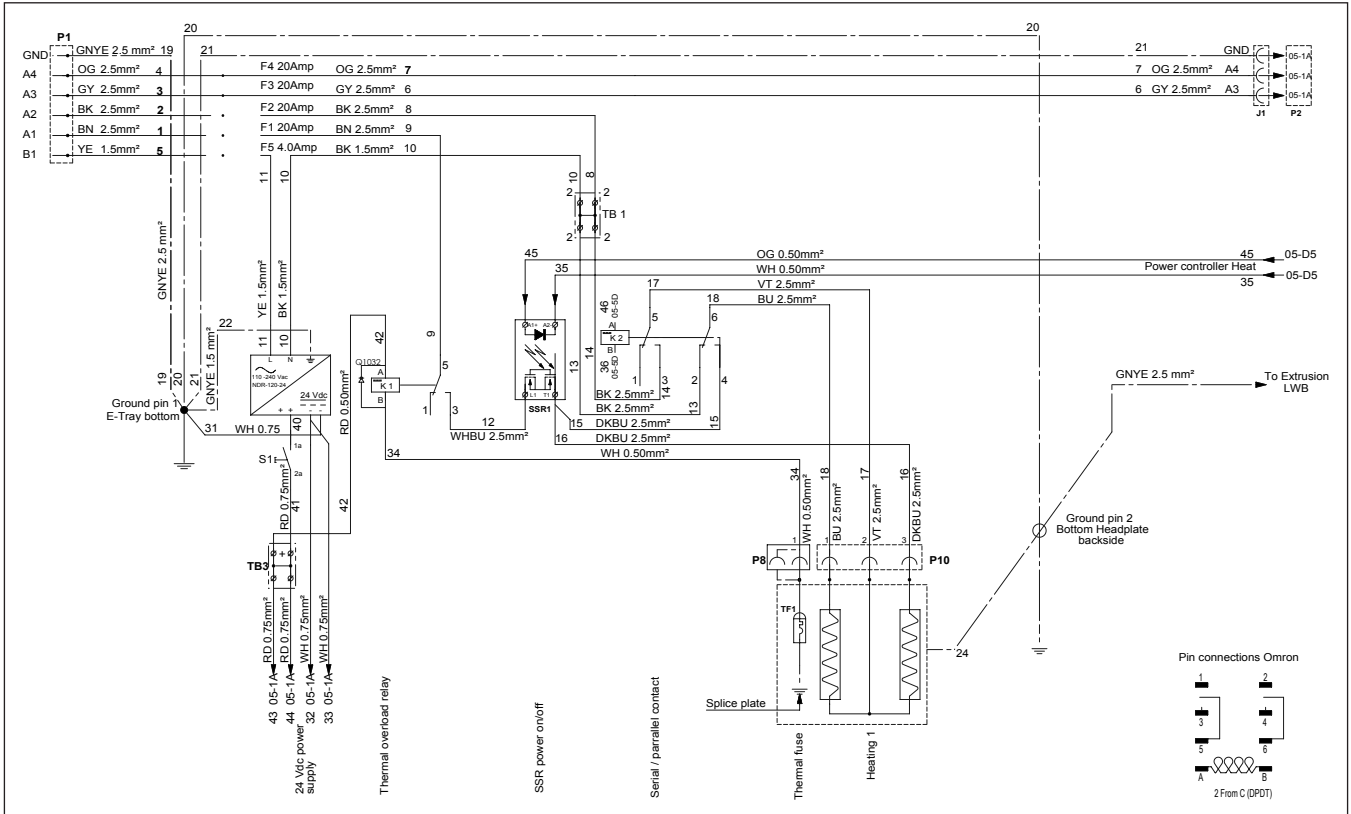

Schematics

Schematics Upper Press 925

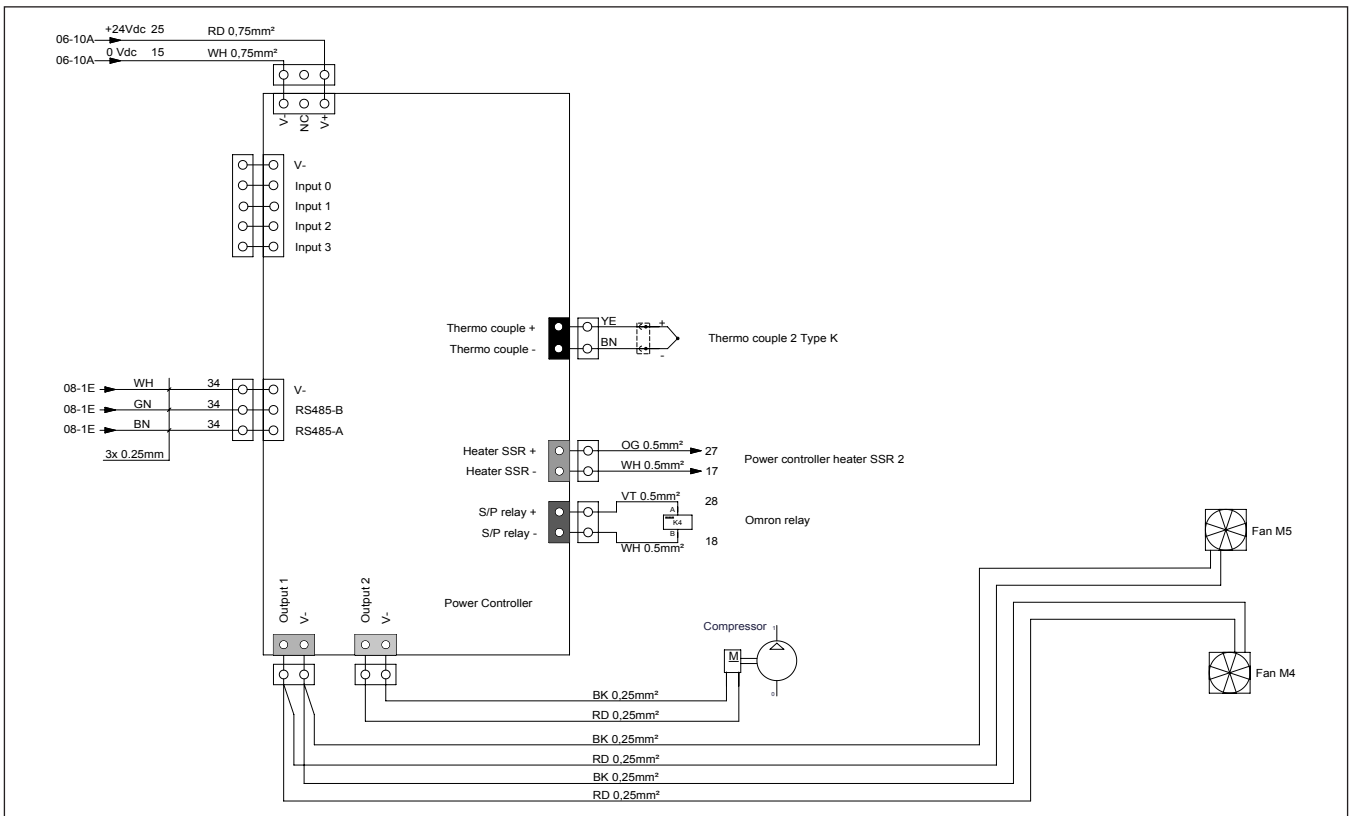
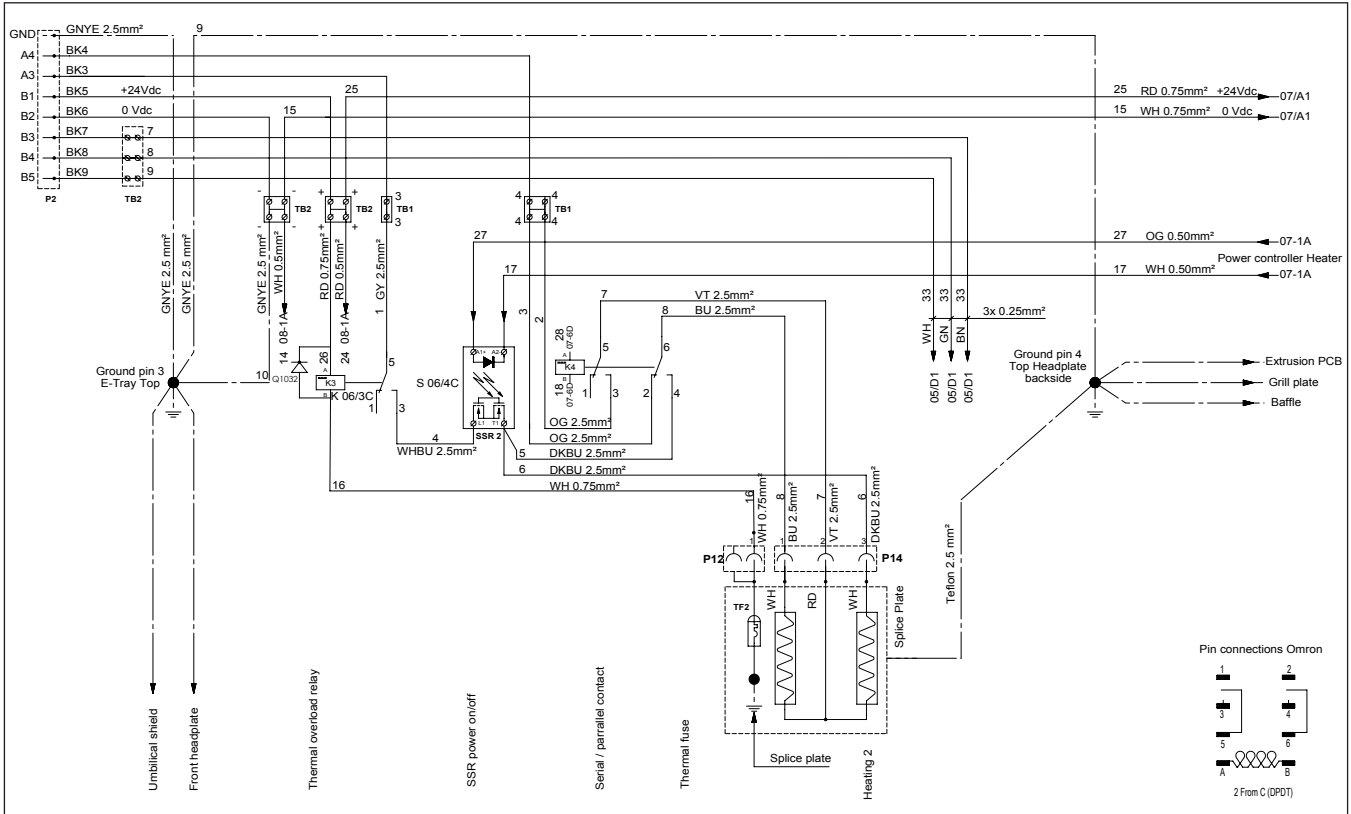

Schematics

Schematics Lower Press 1225

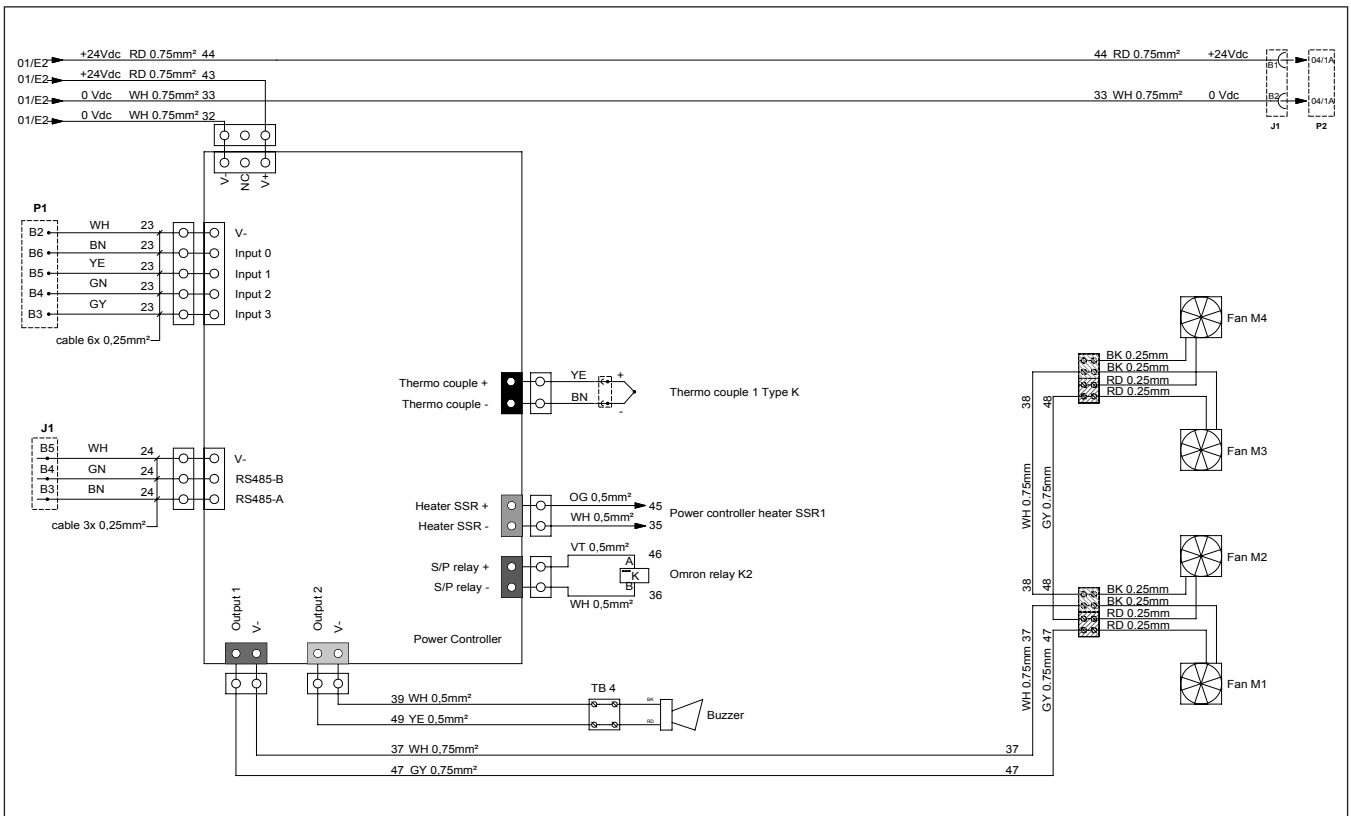
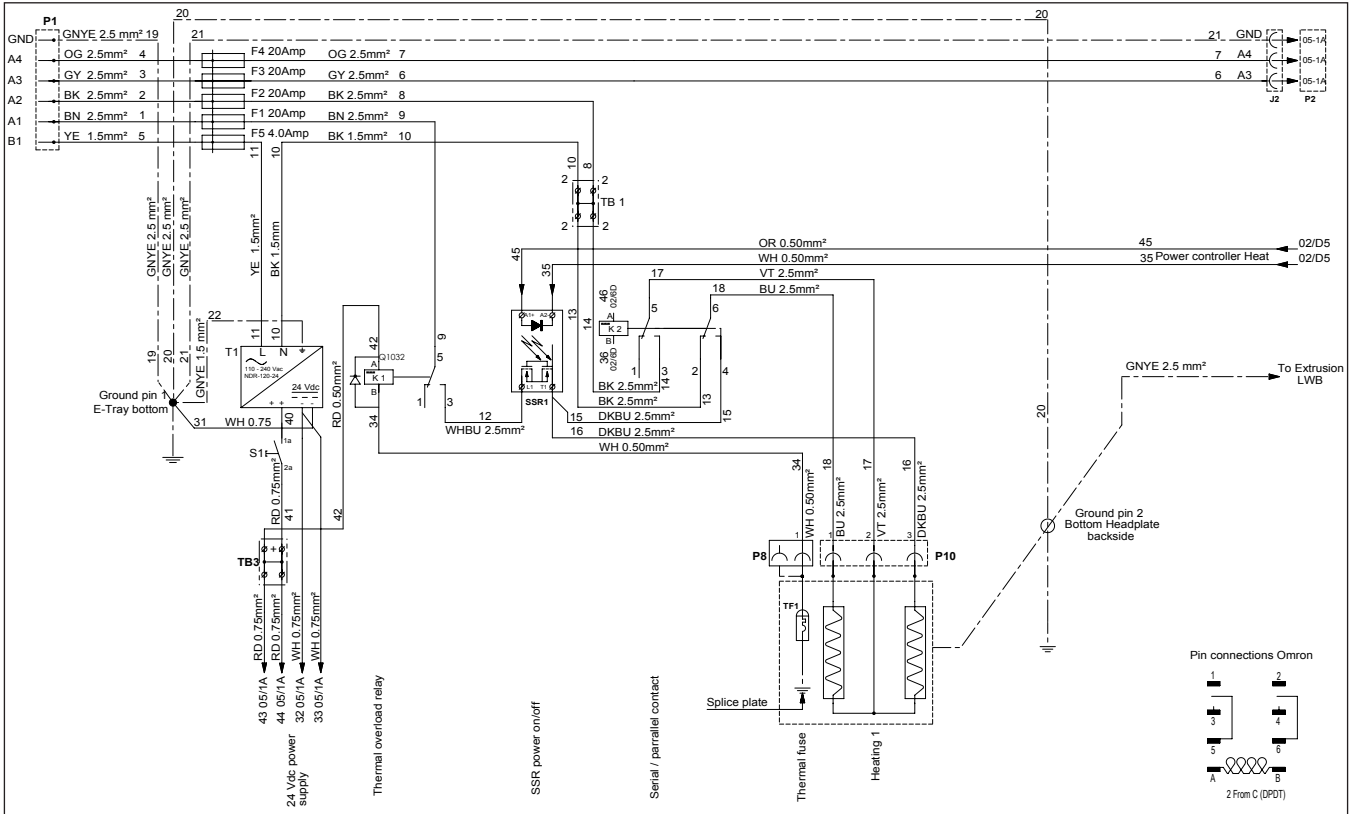

Schematics

Schematics Upper Press 1225

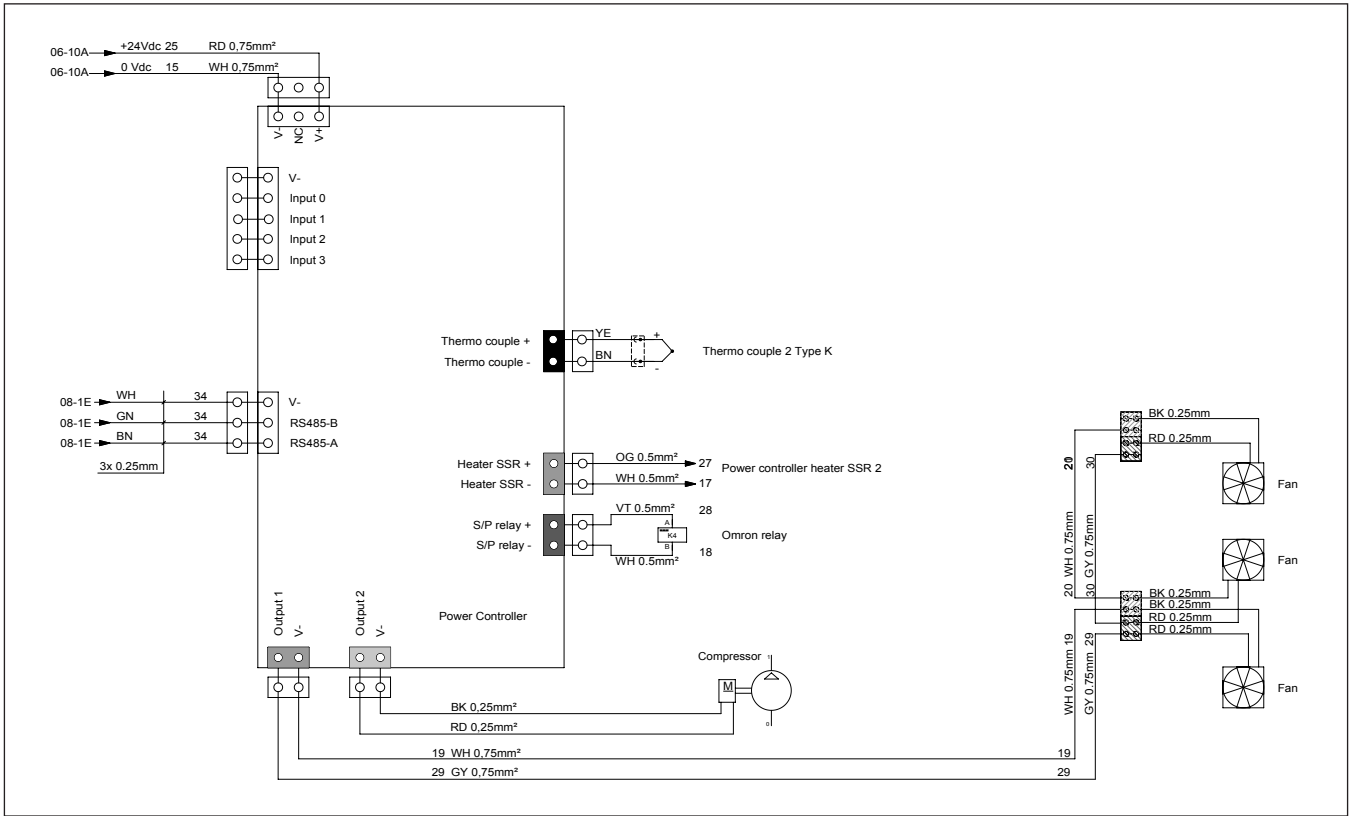
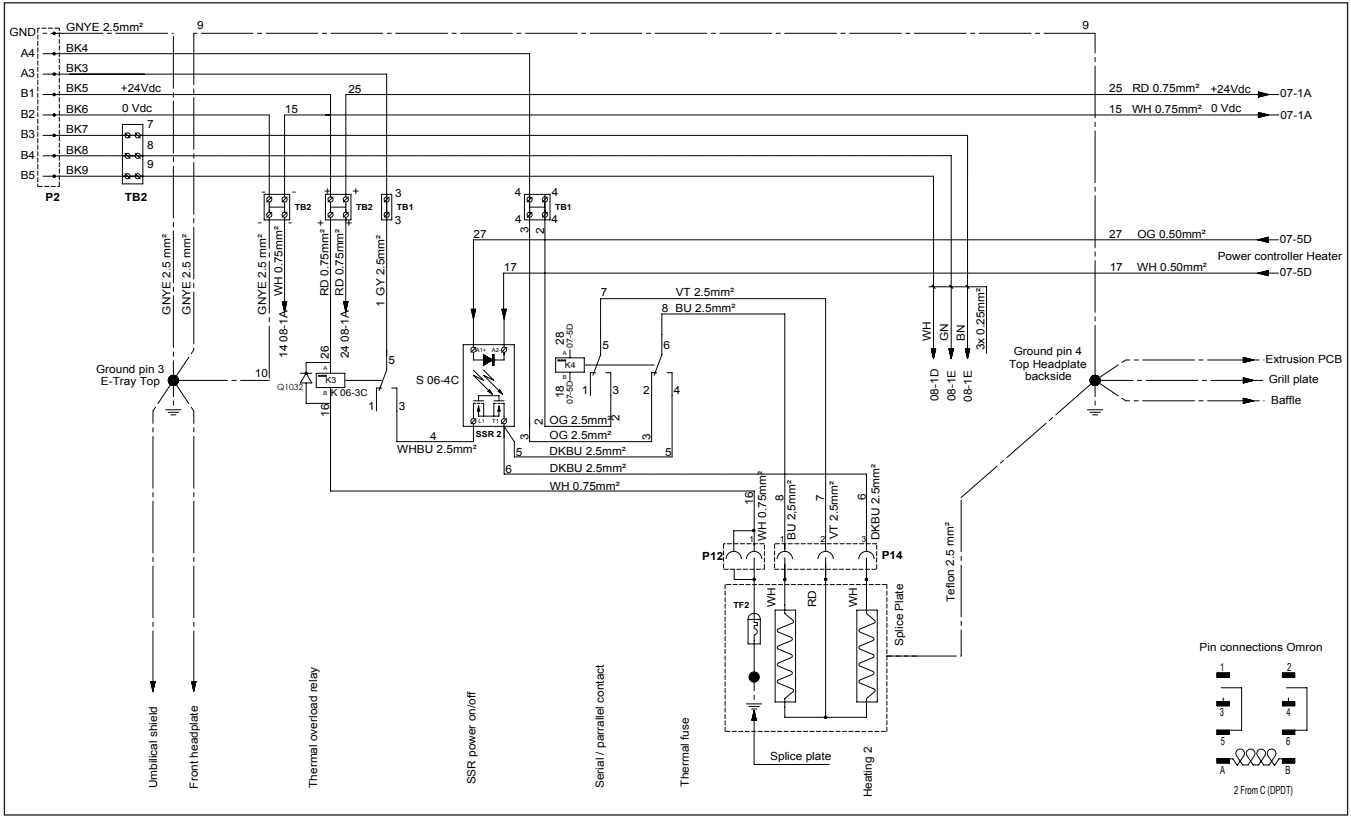

Schematics

Schematics Lower Press 1525

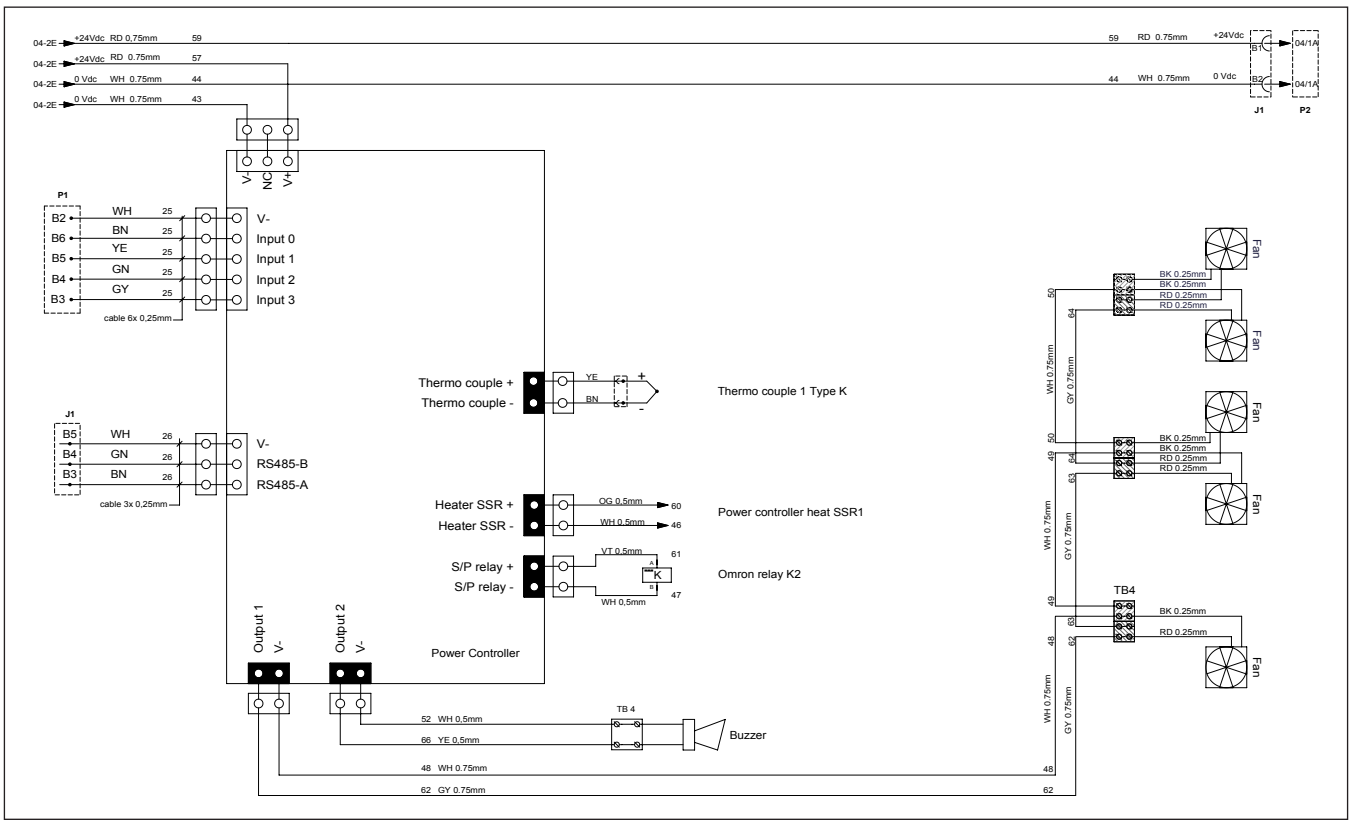
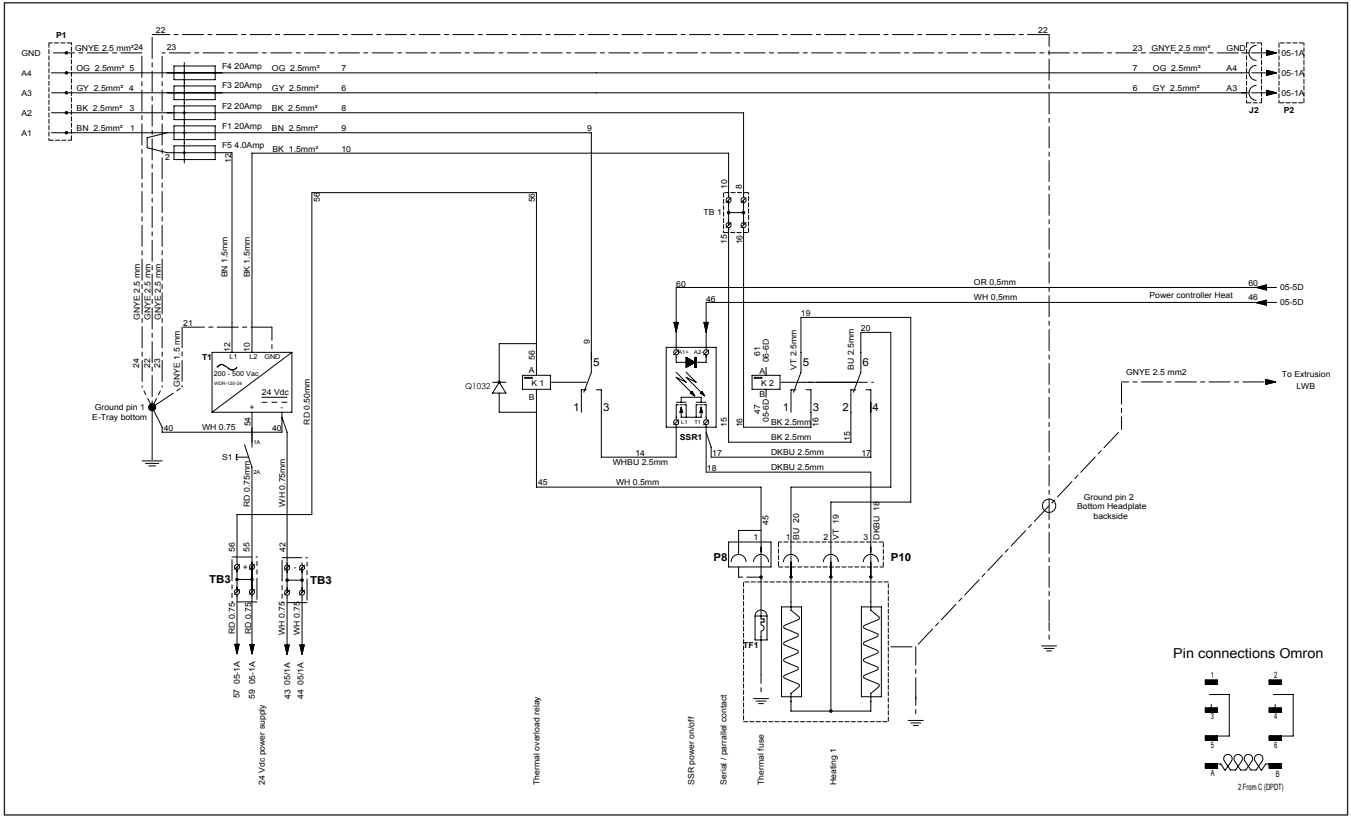

Schematics

Schematics Upper Press 1525

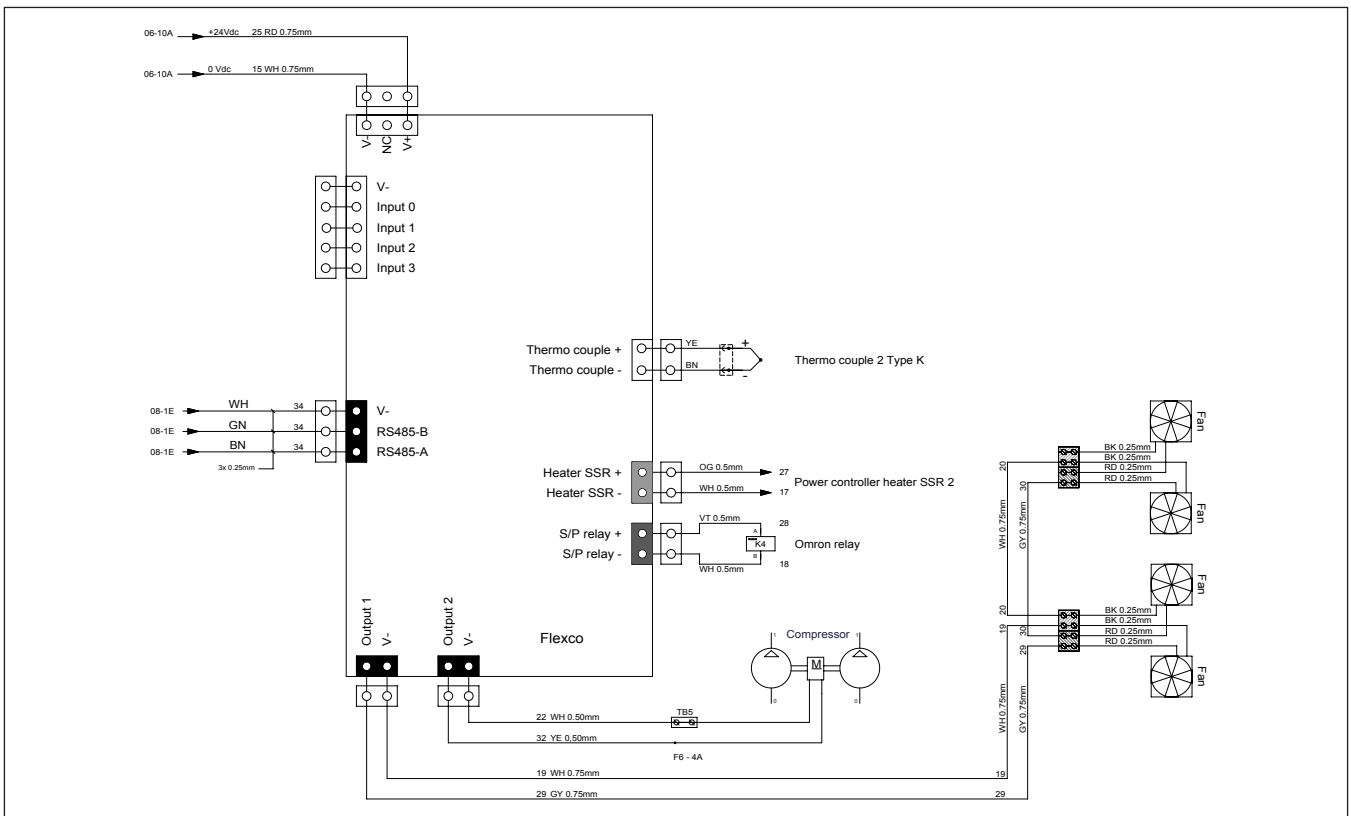
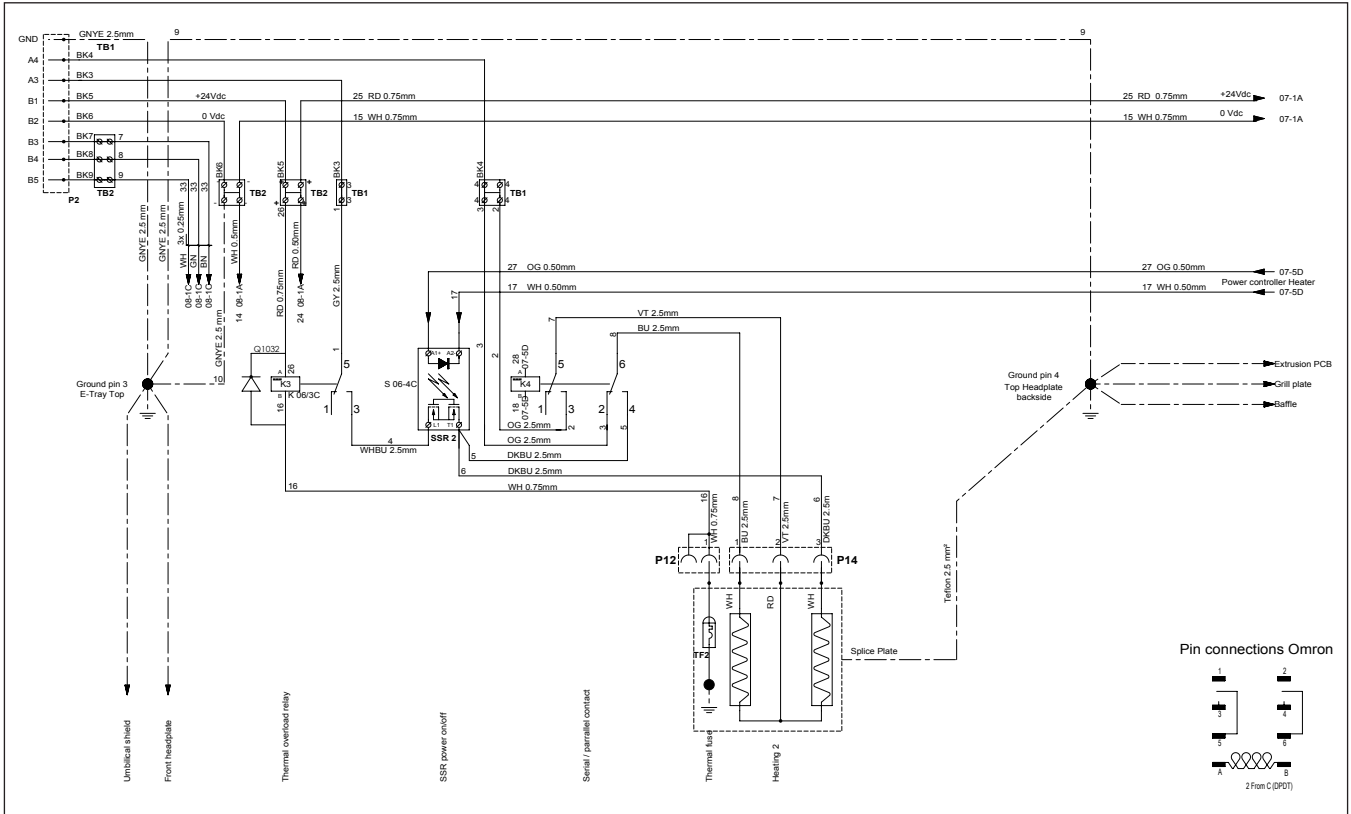

Schematics

Schematics Lower Press 1835

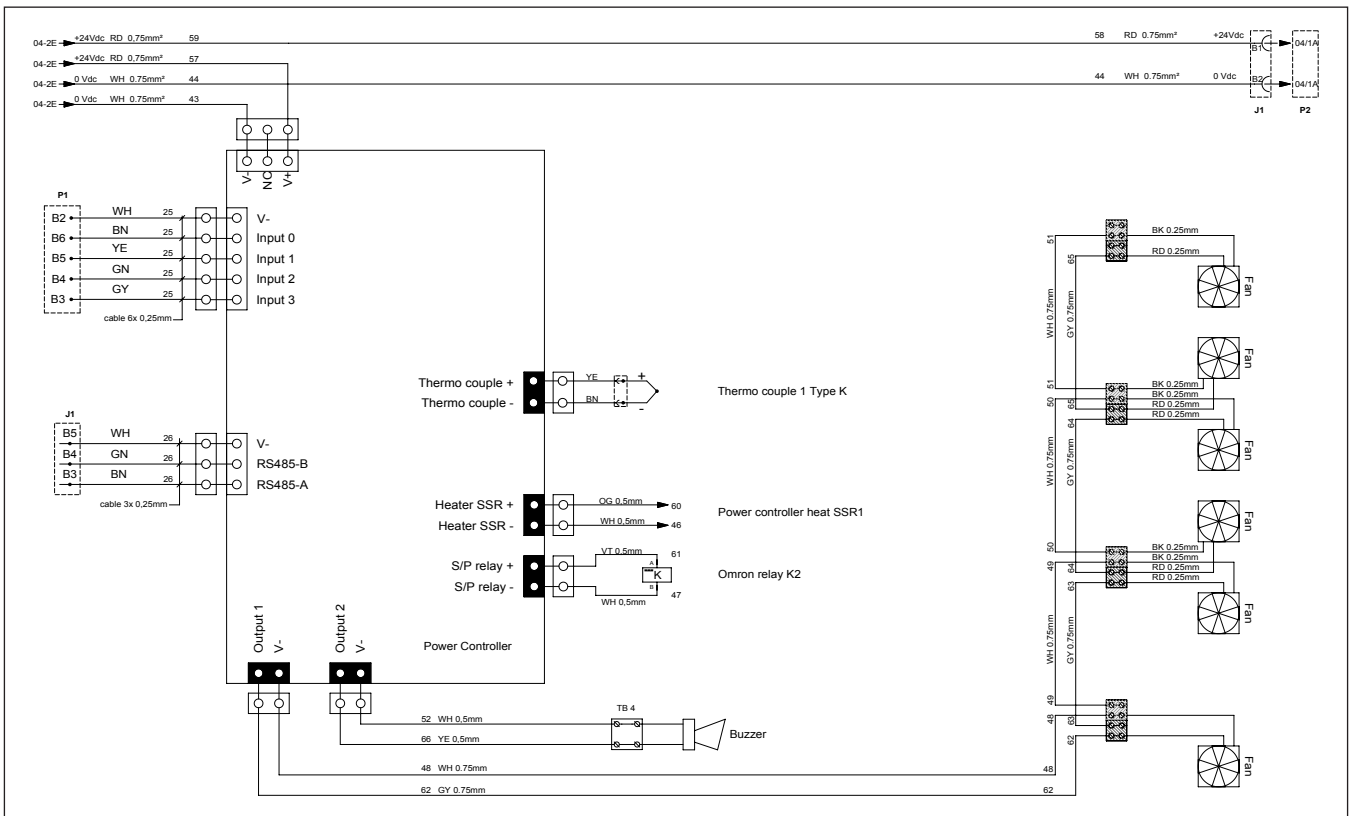
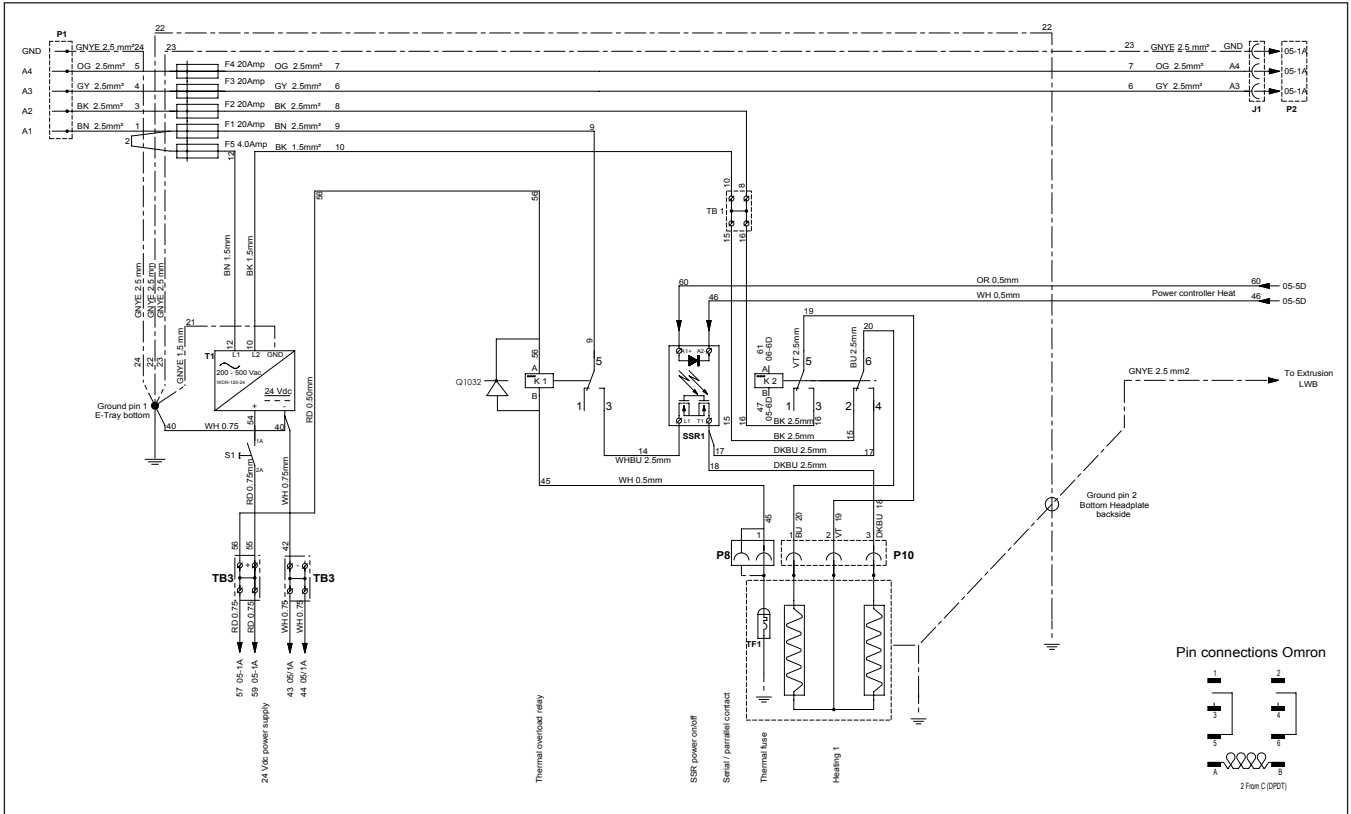

Schematics

Schematics Upper Press 1835

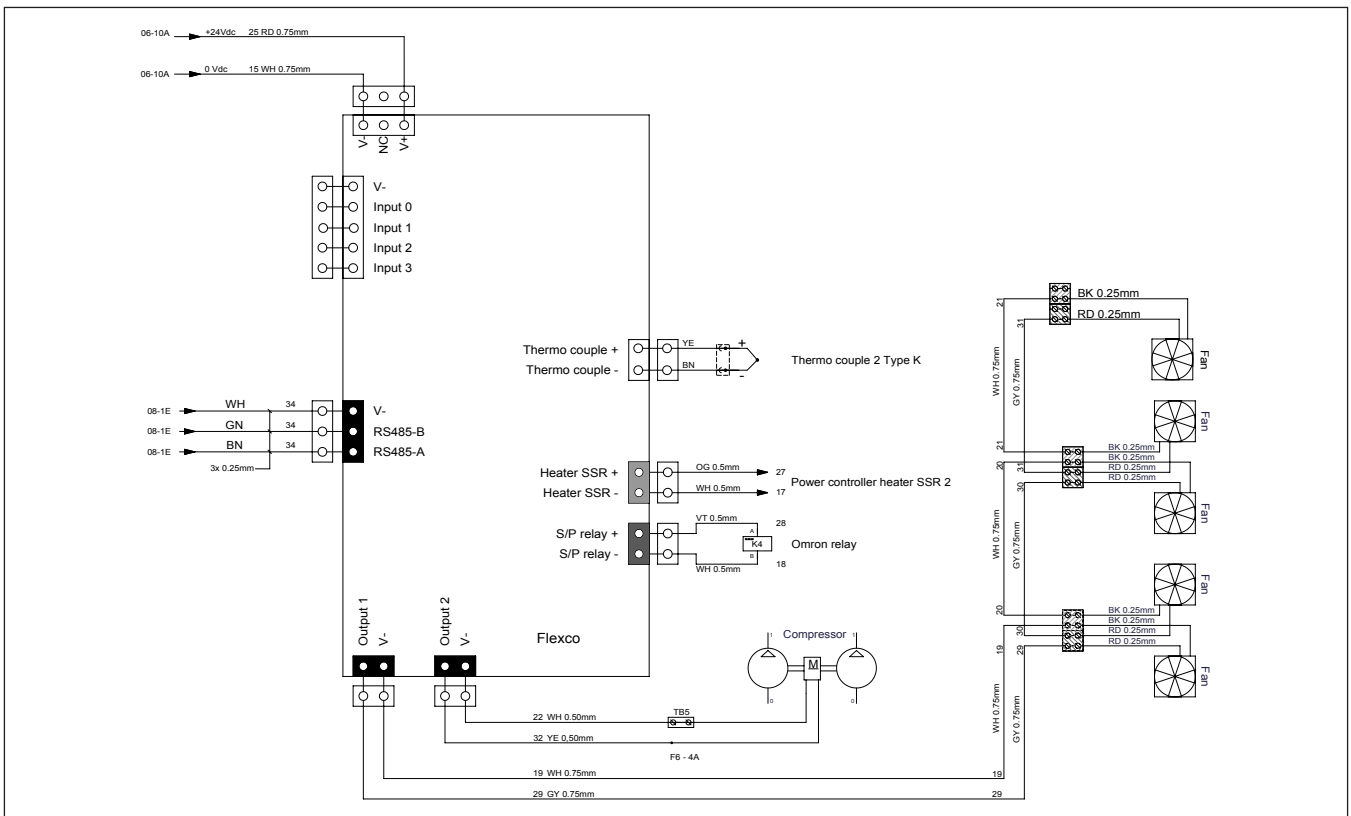
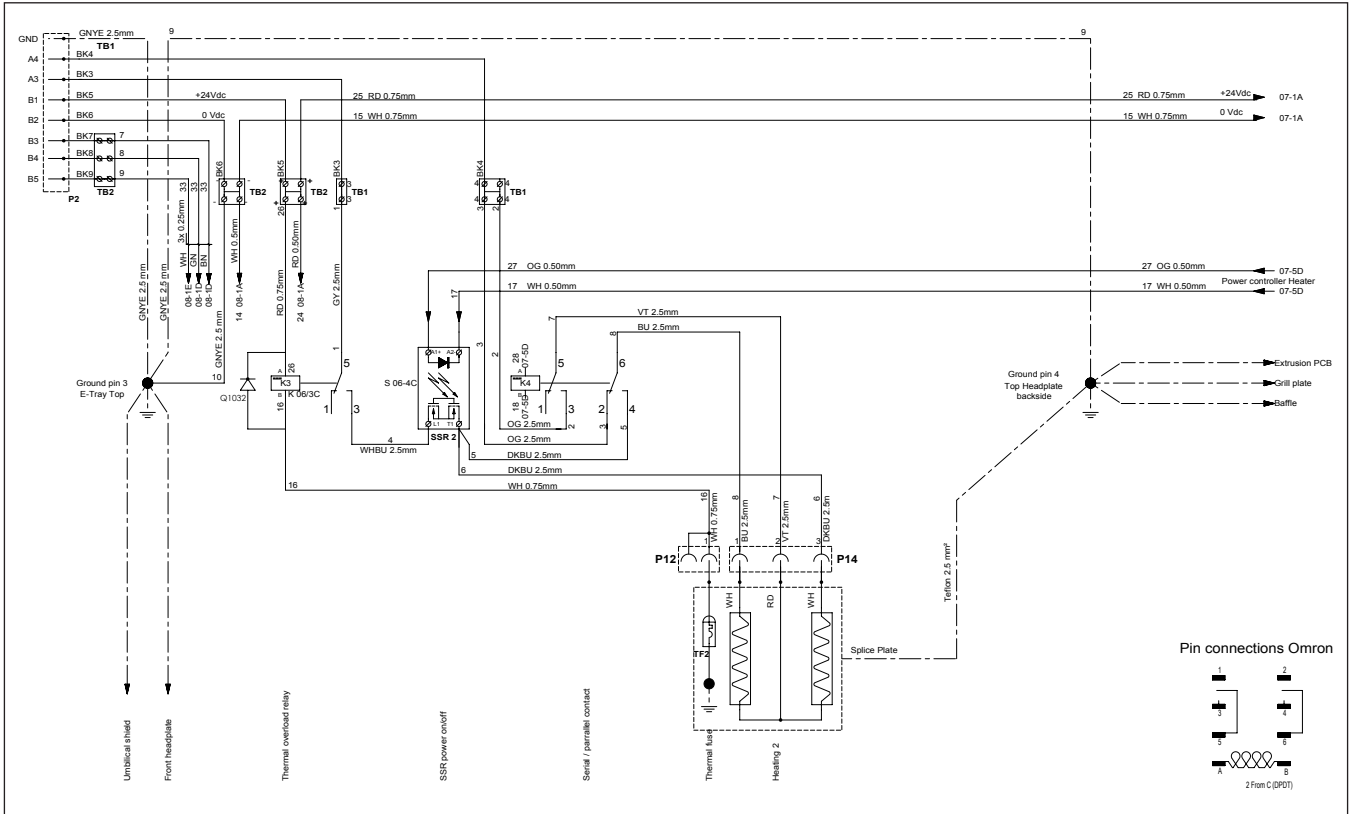

Schematics

Schematics Lower Press 2135

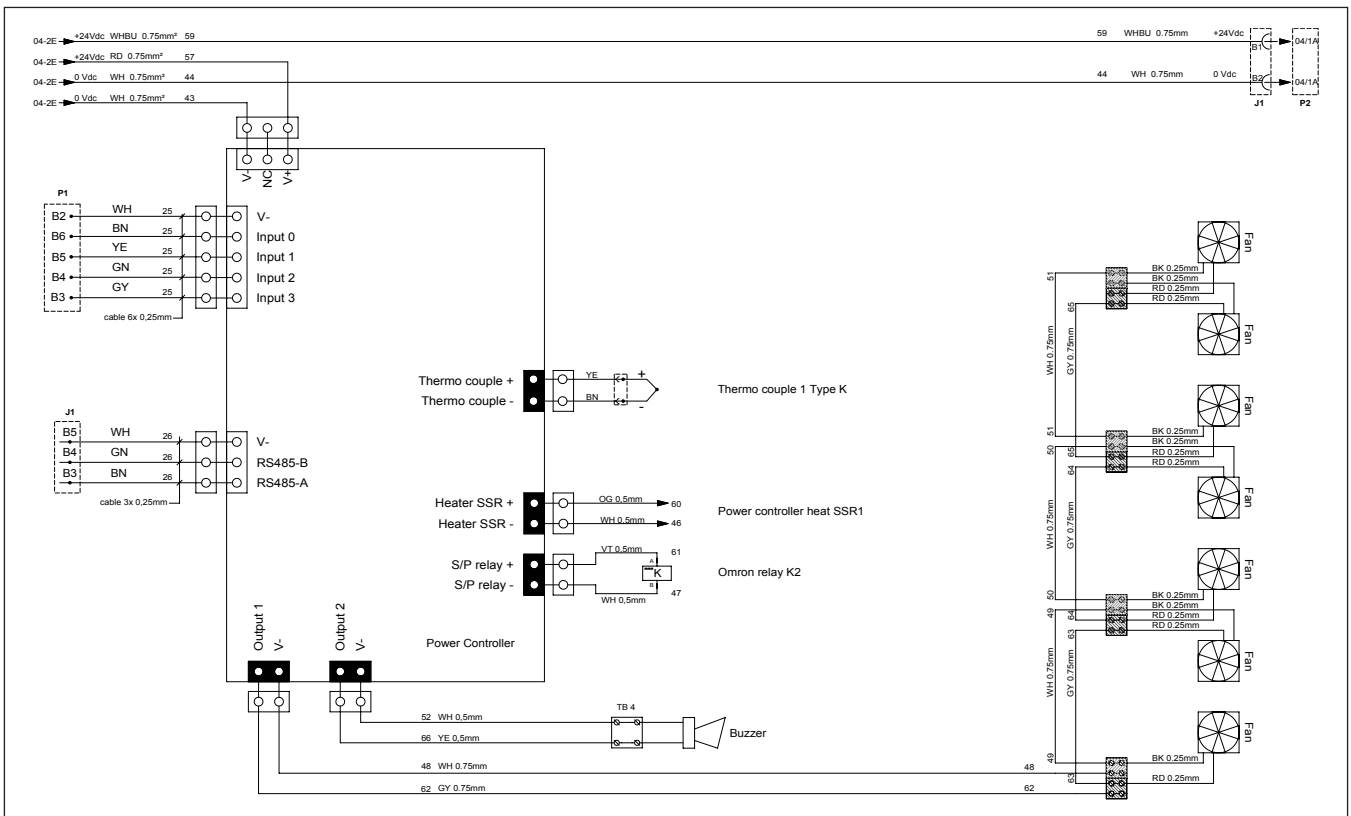
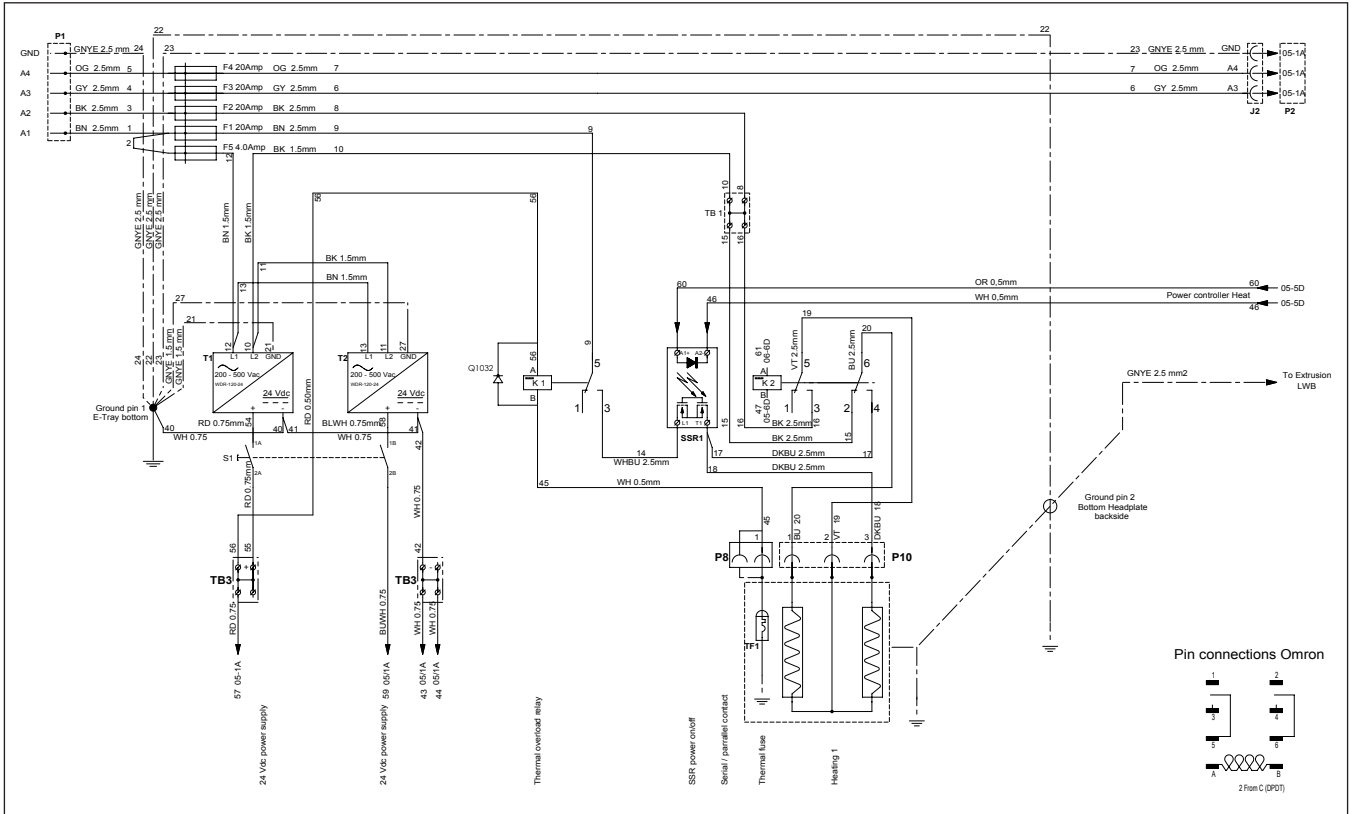

Schematics

Schematics Upper Press 2135

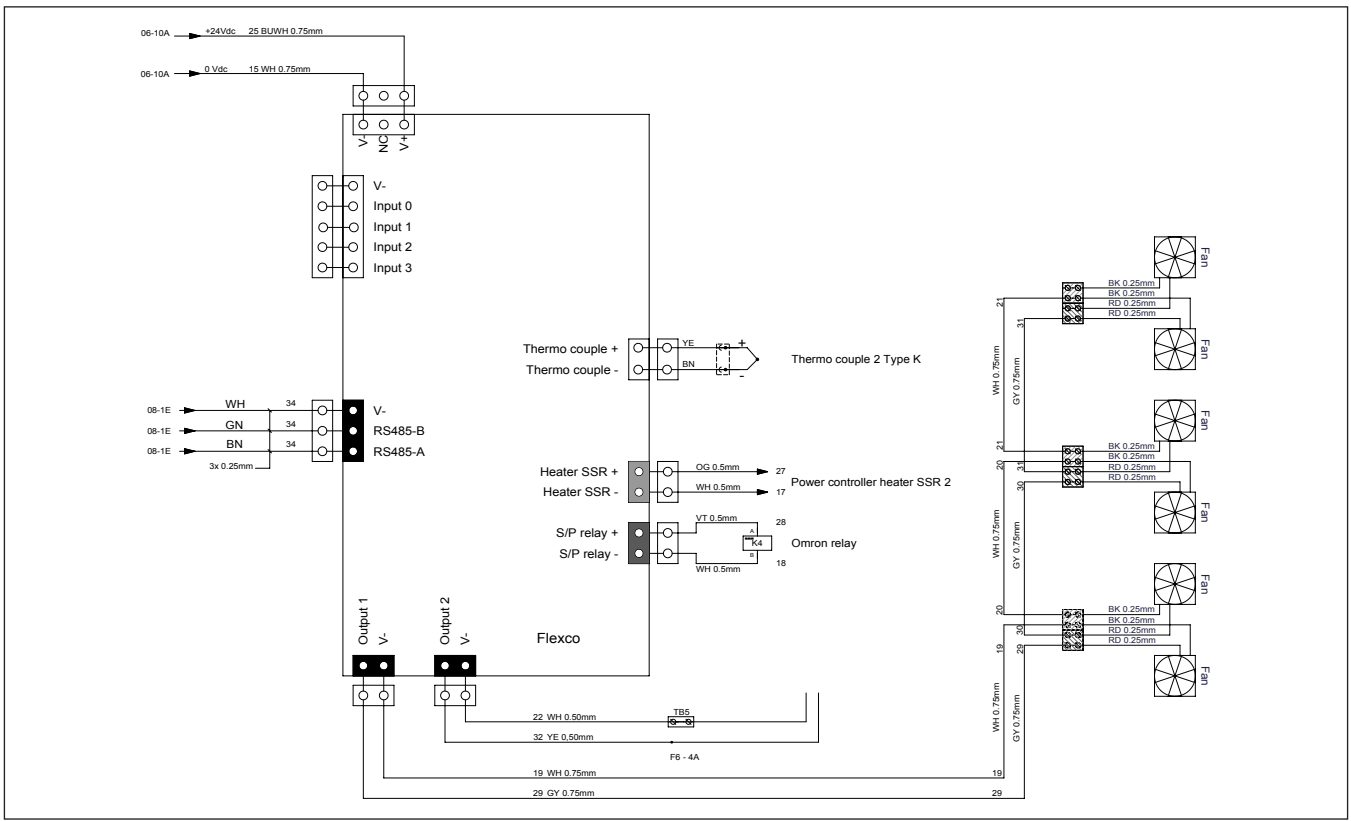
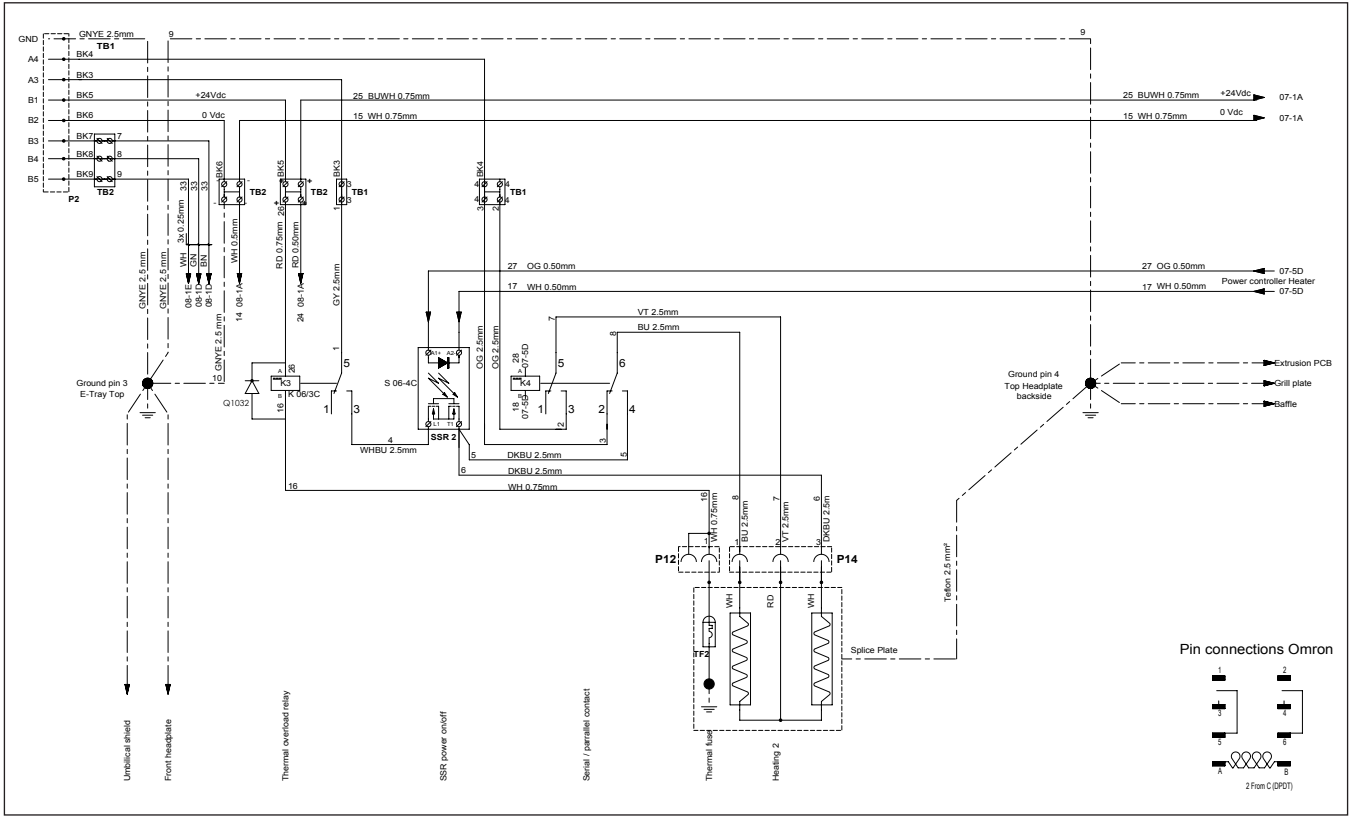

Diagnostics

The Aero® press is programmed to detect some potential errors, which could lead to poor splice results or possibly damage to the press. There are two types of error messages which will be displayed: Warning or Caution. If an error is detected, a message will display on the screen and it is imperative to follow the message.

Warning Messages: These are the more serious potential press errors. The message will advise the potential diagnosis, failure notification and action the operator should take, such as disconnect power. A continual warning beep is sounded until power is disconnected. It is not possible to continue operation of the press, as continued use will lead to a more serious issue. The required action is to arrange for press repair by contacting your local Flexco Customer Service.

Caution Messages: These messages will alert the operator of potential press misuse or unusual cycle activity. The message will advise potential diagnosis, failure notification and action the operator should take, such as, check press connector bolts. A continual warning beep is sounded, which may be turned off by pressing green start button. The operator may continue to operate press in caution state; however, splice results may vary. If the press is used in this state and the problem becomes more serious, the press will then display a Warning Message. Depending on the issue, a potential action may be to arrange for press repair by contacting your local Flexco Customer Service.

Warning example:

Potential Warning Error: Top heating exceeds recipe maximum temperature

Displayed Message	Audible and LED Alarms	Action
Warning ##	Fast Beep	Contact local Flexco Customer Service to coordinate repair.
Process Stopped	No Beeper Reset	
Unexpected Heat	LED Is Red	
Disconnect Power		

Caution example:

Potential Caution Error: Press does not reach recipe maximum pressure in required amount of time

Displayed Message	Audible and LED Alarms	Action
Caution ##	Slow Beep	Press green start button to halt beep. Check to ensure all 4 press connector bolts are secure. Then press green start button to continue splice process.
Processed Paused	LED Is Yellow	
Are clamp bolts tightened?		
Proceed Process?		

Maintenance

H1

Inspection Items

Inspection Task	Every Cycle	Every 100 Cycles	Every 1000 Cycles
Inspect press connector bolt condition and replace if condition is degraded.			X
Inspect platen condition and clean (G2) or replace as needed.	X		
Inspect extrusion and head plates for any signs of fatigue.		X	
Inspect power connector pins for signs of arcing or wear.			X

G2

How to Clean the Platens

To clean the top and bottom platens, place an all-purpose cleaner on a clean cloth and wipe platens. For area requiring further cleaning use a nylon abrasive pad.

H3

Spare Parts List

Item Code	Ordering Number	Description
08650	AERO-COMPRESSOR-SMALL	Compressor 325-1225
08645	AERO-COMPRESSOR-LARGE	Compressor 1525-2135
08604	AMIGO-FRICTION-TAPE-33X25	Tape for clamp bars
09262	BOLT-CLAMP-TOGGLE-AERO-G3	Press connector bolt
09342	T/C-SUBASSY-AERO-G3	Thermocouple
09341	CABLE-UMBILICAL-AERO-G3	Top beam umbilical power cable
09343	FUSE-ASSY-THERMAL-AERO-G3	Thermofuse
09351	FUSE-ASSY-CERAM-FL-0326020.MSP	Main power fuse 325-1225
09374	CARTRIDGE-FUSE-F-20A-RS-3375256	Main power fuse 1525-2135
08700	AERO-FUSE-CERAMIC-4A	Power supply fuse/Large compressor fuse 1525-2135

Contact Flexco's Customer Service if other parts are required: www.flexco.com.

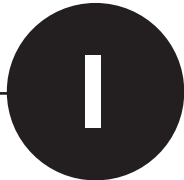

WEEE

Flexco takes WEEE compliance very seriously. This equipment is intended to be repairable in foreseeable circumstances. Should product disposal be required, contact Flexco Europe at 011-49-7428-9406-0 or Flexco UK at 011-44-1274-600-942.

EU DECLARATION OF CONFORMITY

Product: AERO Splice Press

Manufacturer: Flexible Steel Lacing Co. (Flexco)
1995 Oak Industrial Dr. NE
Grand Rapids, Michigan 49505

European office: Flexco Europe
Leidringer Strasse 40-42
D-72348, Rosenfeld Germany
Telephone 49-7428-9406-0

This declaration of conformity is issued under the sole responsibility of the manufacturer.

Object of this declaration:



AERO Splice Press models—
325, 625, 925, 1225, 1525, 1835, 2135
Other colors apply.

The object of the declaration described above is in conformity with the relevant Union harmonization legislation.

Conforms to European Directives:

2006/42/EC
2014/30/EU
2002/95/EC

Machinery Directive
Electromagnetic Compatibility Directive
RoHS Directive – Amended per Directive 2011/65/EU & 2015/863/EU

Harmonized Standards and Technical Specifications applied:

ISO 12100:2010	Safety of machinery—General principle for design—Risk assessment and risk reduction
IEC 60204-1:2005/A1:2008	Safety of machinery—Electrical equipment of machines—Part 1
IEC 61000-6-2:2005	Electromagnetic Compatibility (EMC)—Part 6-2: Generic standards—Immunity for industrial environments
IEC 61000-6-4:2011 ♦	Electromagnetic Compatibility (EMC)—Part 6-4: Generic standards—Emission standard for industrial environments
IEC 61000-3-2:2014	Electromagnetic Compatibility (EMC)—Part 3-2: Limits—Limits for harmonic current emissions (equipment input current \leq 16 A per phase)
IEC 61000-3-3:2013	Electromagnetic Compatibility (EMC)—Part 3-3: Limits—Limitation of voltage changes, voltage fluctuations and flicker in public low-voltage supply systems, for equipment with rated current \leq 16 A per phase and not subject to conditional connection.
EN 50581:2012	Technical documentation for the assessment of electrical and electronic products with respect to the restriction of hazardous substances.

♦--Reference Standard

Signed for and on behalf of:

Flexible Steel Lacing Company (Flexco)

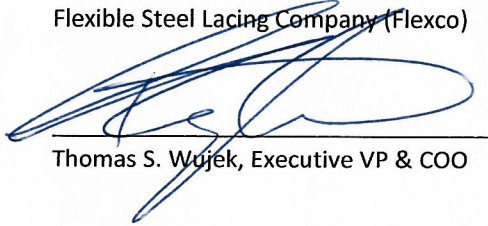
Thomas S. Wujek, Executive VP & COO

February 21, 2020
Date

Visit www.flexco.com for other Flexco locations and products, or to find an authorised distributor.

©2021 Flexible Steel Lacing Company. 01-06-25. X5003

