

Amigo™

Safety and Operation Manual

Amigo 625 and 1000

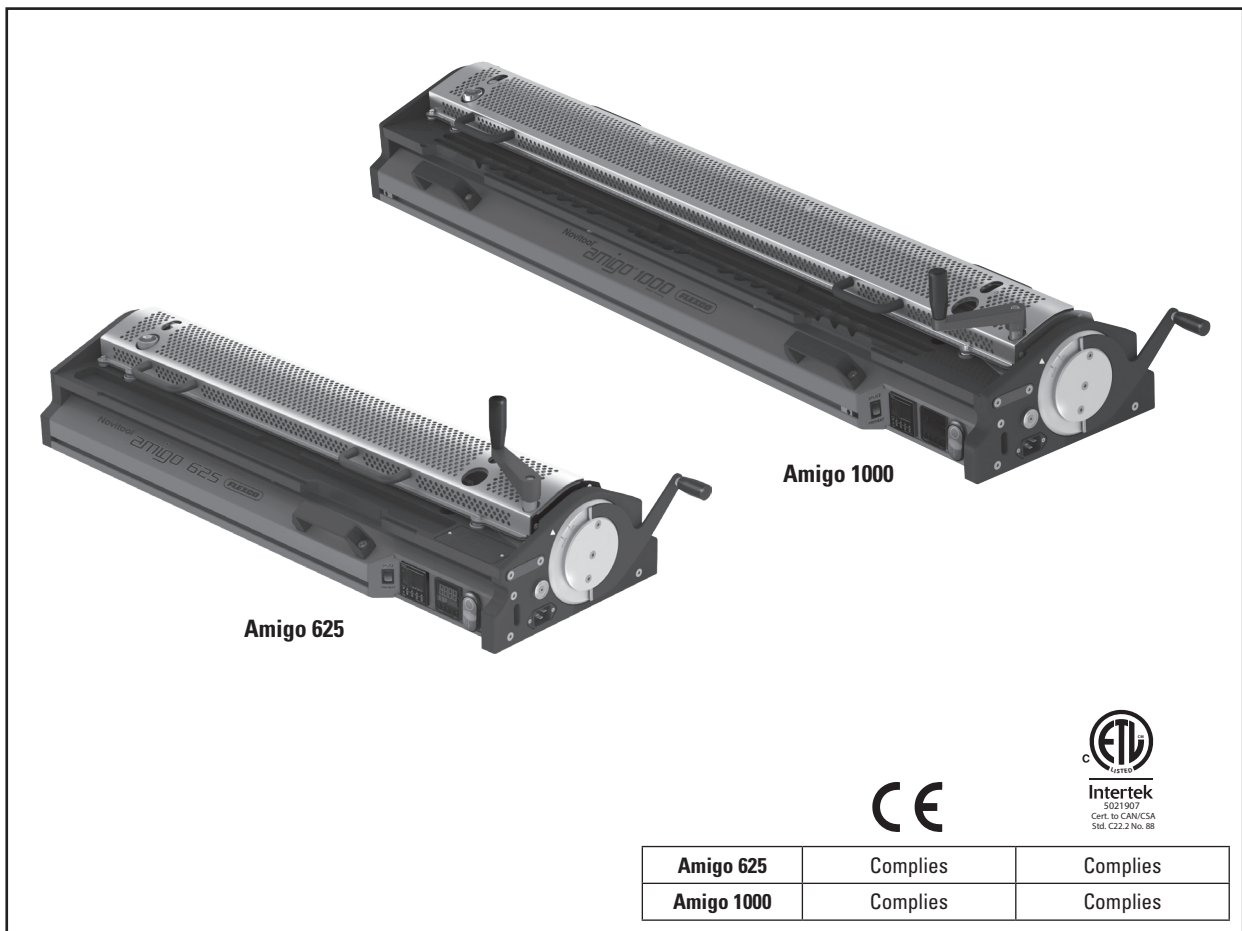

WARNING

IMPROPER OR UNSAFE use of this tool can result in serious bodily injury! This manual contains important information about product function and safety. Please read and understand this manual BEFORE operating the tool. Please keep this manual available for other users and owners before they use the tool. This manual should be stored in a safe place.

Table of Contents

Main Components Amigo™	3
Description.....	4
Machine Specifications	4
General Safety Rules.....	5
Prepare for Use	7
Machine Set Up	8
Platen Stop Set Up.....	10
Prepare Belt Ends for Splicing	14
Prepare for Splice.....	23
Splice	27
Operating Parameters	37
Service and Maintenance.....	38
Troubleshooting.....	48
Schematics.....	50
Replacement Parts.....	52
Belt Template Ordering Information.....	53
Amigo™ Return Side.....	55
Warranty	56

Main Components Amigo™

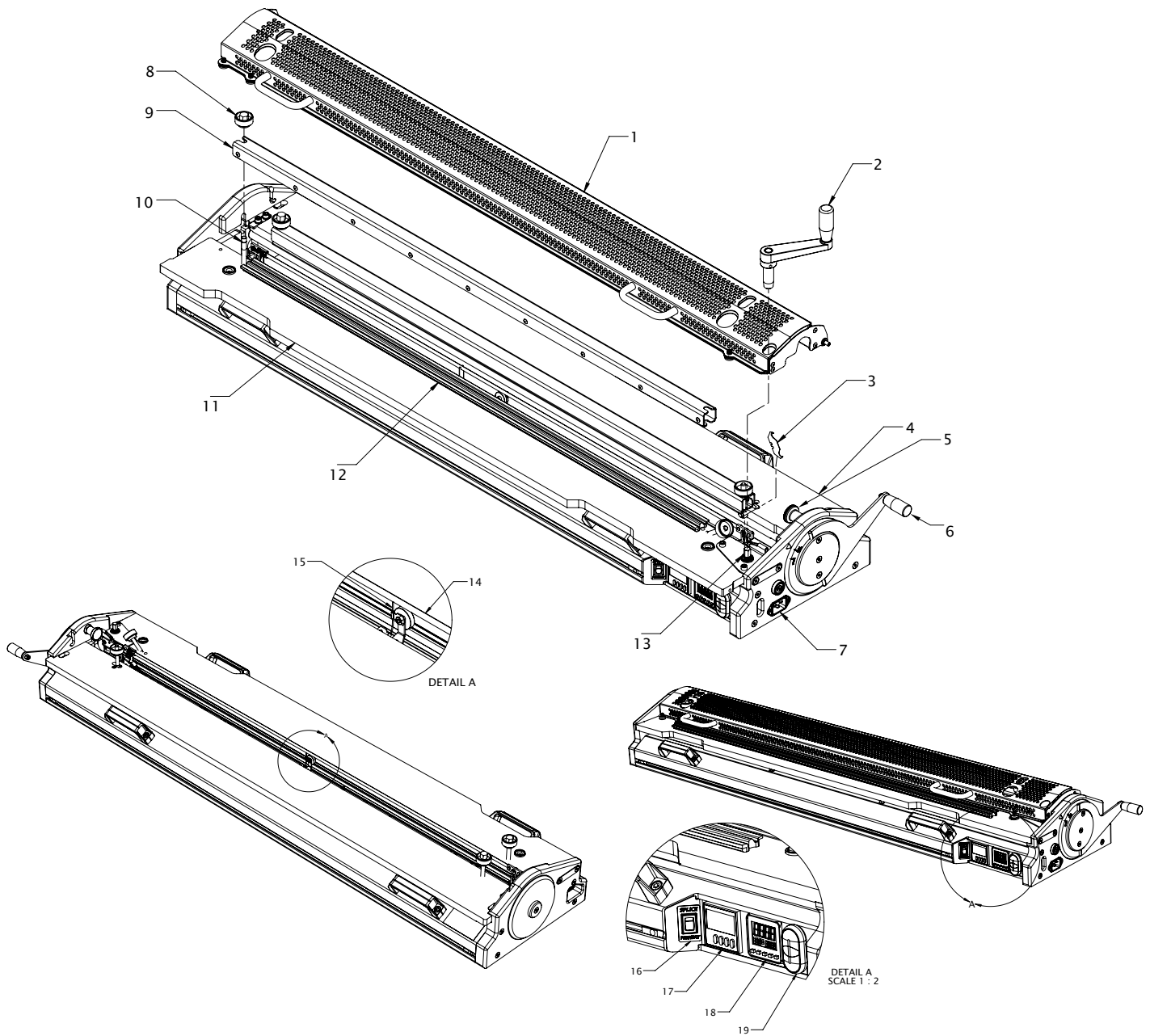

- | | | | |
|-------------------------|--------------------|------------------------|----------------------------|
| 1. Guard | 6. Actuating Lever | 11. Stationary Platen | 16. Heating Mode Switch |
| 2. Cutter Crank | 7. Power Inlet | 12. Belt Template | 17. Timer |
| 3. Cutting Blade | 8. Clamp Thumb Nut | 13. Cutter Drive Shaft | 18. Temperature Controller |
| 4. Movable Platen | 9. Belt Clamp Bar | 14. Emitter | 19. Start/Stop Switch |
| 5. Position Locking Pin | 10. Clamp Stud | 15. Thermocouple | |

Description

The Amigo™ is designed to cut and splice, thermoplastic homogeneous (monolithic) conveyor belts. Belts designed to be tension driven or those requiring a positive drive may be fabricated using this machine.

Belt ends are prepared for splicing using integrated belt cutter. Interchangeable templates ensure accurate cut length and pitch of positive drive belts. Preheating belt ends inside enclosed guarded heat zone ensures quality repeatable splices in a

wide variety of ambient temperatures. Integrated contactless heating allows for controlled melt amounts of belt ends.

Less than one minute of splice heat is often required to ensure a quality splice. Heat source retracts inside unit and quickly cools simultaneously as molten belt ends are spliced together. The Amigo™ is an ideal machine for working on location, as well as in the workshop. A transport case is included for convenient movement to and from job sites.

Machine Specifications

Dimensions

Amigo™ Dimension Information		
Amigo 625	L x W x H, mm (in)	Weight, kg (lb)
Machine	1000 mm (39.4 in) x 315 mm (12.4 in) x 170 mm (6.7 in)	24.5 kg (54 lb)
Transport Case (Includes additional Templates & support equipment)	1210 mm (47.7 in) x 490 mm (19.3 in) x 385 mm (15.2 in)	31 kg (68 lb)
Total		55.5 kg (122 lb)
Amigo 1000	L x W x H, mm (in)	Weight, kg (lb)
Machine	1425 mm (56.1") x 315 mm (12.4") x 170 mm (6.7")	38.5 kg (85 lb)
Transport Case (Includes additional Templates & support equipment)	1700 mm (66.9") x 490 mm (19.3") x 385 mm (15.2")	36.3 kg (80 lb)
Total		74.8 kg (165 lb)

Capacities

- Amigo 625 Maximum belt width: 625 mm (24.5")
- Amigo 1000 Maximum belt width: 1067 mm (42")
- Minimum belt length around press frame: 900 mm (36")
- Maximum belt thickness: 4 mm* (0.157")

*For splicing – **Note!** Belts greater than 4 mm may be spliced but maximum thickness is somewhat dependent on material composition.

Operating Conditions

- Ambient Temperature: -20°C to +40°C (4°F to +104°F)
- Minimum machine temperature: -10°C (14°F)
- Non-condensing/non-icing humidity
- Machine clearance (minimum): 300 mm (12") surrounding machine
- Indoor use only

Storage & Transportation Conditions

- Ambient temperature: -25°C to +65°C (-13°F to 149°F)
- Non-condensing/non-icing humidity

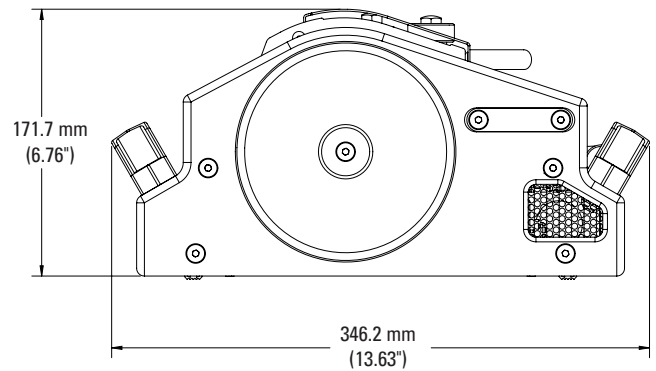

Electrical Characteristics

Amigo 625	1-phase 115 vac 10 amps	1150 Watts
	1-phase 230 vac 5.5 amps	1265 Watts
Amigo 1000	1-phase 115 vac 15 amps	1750 Watts
	1-phase 230 vac 7.5 amps	1750 Watts

General Safety Rules – Save These Instructions

Signal words:

“DANGER” indicates an imminently hazardous situation which, if not avoided, will result in death or serious injury. This signal word is limited to the most extreme situations.

“WARNING” indicates a potentially hazardous situation which, if not avoided, could result in death or serious injury.

“CAUTION” indicates a potentially hazardous situation which, if not avoided, may result in minor or moderate injury. It may also be used to alert against unsafe practices.

Safety Symbol



This international safety symbol is used to identify and call attention to specific safety matters.

Safety Information

To avoid severe personal injury or property damage, read carefully and understand the following Safety Precautions.

1. WORK AREA

DANGER

Do not operate power tools in explosive atmospheres, such as in the presence of flammable liquids, gases, or dust. Power tools create sparks which may ignite the dust or fumes.

CAUTION

Keep your work area clean and well lit. Cluttered benches and dark areas invite accidents.

2. ELECTRICAL SAFETY

DANGER

The Amigo™ is a single insulated machine and needs a multiple wire grounded power cord and grounded power supply system. Do not modify electrical cables provided. Use only approved 20 amp minimum 115 vac, or 15 amp minimum 230 vac protected supply circuit.

Ensure machine, power cable and power source are not positioned in standing water or exposed to wet conditions.

Do not connect machine to power or operate machine if machine is wet.

Service shall only be performed by a qualified electrician. Power shall be removed before service. Stored mechanical energy exists in emitter tensioning system. Follow Lock-Out Tag-Out procedures. Observe proper maintenance procedures. Do not modify electrical circuit.

NOTE—Residual electrical power exists for a time after external power supply is disconnected. DO NOT SERVICE until power supply fully discharges. Wait until controller displays show no power and go dark.

Never contact emitter or supporting components unless power is removed and unit shows no residual power on controllers.

WARNING

Do not use outdoors. This machine is designed for indoor use only.

Inspect machine before each use. Ensure machine and power cable are not damaged. Machine shall not be operated with damaged controllers, switches, emitter or other mechanical components.

Avoid dropping or severe handling of machine at all times, including during movement in transport case.

If the electrical supply cord is damaged, it must be replaced by a special cord available from the manufacturer or its service agent.

3. PERSONAL SAFETY

WARNING

Use safety equipment. Always wear eye protection. Dust mask, non-skid safety shoes, hard hat, or hearing protection must be used for appropriate conditions.

Stay alert, watch what you are doing, and use common sense when operating a machine. Do not use machine while tired or under influence of drugs, alcohol, or medication. A moment of inattention while operating machines may result in serious personal injury.



General Safety Rules – Save These Instructions

Dress properly. Do not wear loose clothing or jewelry. Contain long hair. Keep your hair, clothing, and gloves away from moving parts. Loose clothes, jewelry, or long hair can be caught in moving parts.

Two persons are required to lift and move machine, or to lift machine and case (Amigo 1000).

When moving in transport case, ensure casters are locked and blocked and case is strapped securely.

Abide by all instructions and warning labels. This equipment is not to be used by children or persons with reduced physical, sensory or mental capabilities, or lack of experience and knowledge of the equipment. Children must be supervised and must not play with the appliance.

4. USE AND CARE

WARNING

Read and understand Amigo™ operations manual before using machine.

Cut Hazard. Wear cut resistant gloves. Ensure proper cutting and weld skiving procedures and safety practices are followed.

Severe Burn Hazard. Operate only with emitter guard in place. Premature opening of guard can result in personal injury/burn. Observe proper operating procedures. Guard, clamp beams, emitter, emitter support components, clamp thumb nuts, and other adjacent surfaces are hot during and after operation. Use caution when removing guard and clamp bars.

Do not store solvents in Amigo™ transport case.

CAUTION

Only operate Amigo™ with machine positioned on a level, firm surface.

Disconnect plug from power source before making any adjustments, changing accessories, cutting belt, storing, or transporting machine. Such preventive safety measures reduce risk of starting machine accidentally.

NEVER use a machine which is defective or operating abnormally. If machine appears to be operating unusually, making strange noises, or otherwise appears defective, stop using it immediately and arrange for repairs.

Do not use machine if switch does not turn it on or off. Any machine that cannot be controlled with a switch is dangerous and must be repaired.

Check for misalignment or binding of moving parts, breakage of parts, and any other condition that may affect machine operation. If damaged, have machine serviced before using.

The Amigo™ should not be used to cut and splice materials other than thermoplastic monolithic belting.

Maintain machine in clean condition. Remove any oils, greases, or food product from outside and inside machine.

Do not use power drivers with machine cutter system.

Ensure Timer is changed from PREHEAT to SPLICE time prior to initiating Splice cycle. Failure to comply will result in damaged belt.

Prepare for Use

Parts required for use & storage

- Amigo™ Splice Press
- Transport Case & Tow Handle
- Belt Skiver
- 2 mm Hex Driver
- Cutter Crank Handle
- Belt Templates

Recommended parts

- Cutting Blades (spare)
- Friction Tape
- Emitter (spare)
- Unibar® Cutter

Safety and PPE

- Safety Glasses
- Safety Shoes
- Cut Resistant Gloves
- Other PPE as warranted by conditions

Machine Set Up

A1



Open transport case and lift machine from case. **Caution!** Two persons required to lift and place machine. Position machine on even surface with platens up and level. Do NOT apply power until belt is cut and clamped in preparation for splicing. Ensure power inlet, controls, and cutter crank are accessible.

A2



Rotate actuating lever to its operating position.

Machine Set Up

A3



Remove guard from machine.

A4



Remove belt clamp bars from machine.

Platen Stop Set Up

B1

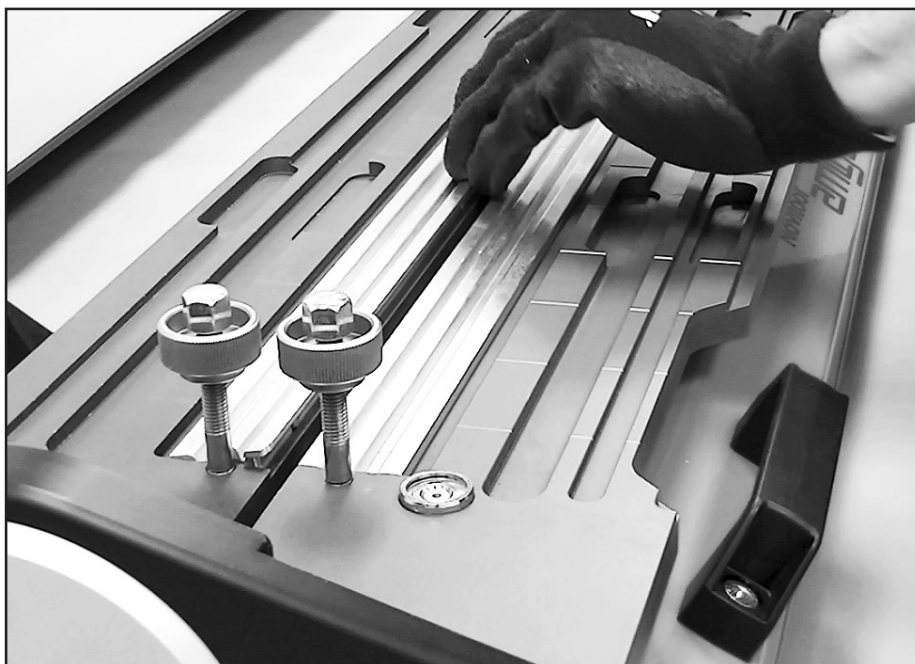

Ensure template and platen receiving slots are clean and debris free. Templates are directional and are keyed to fit in the proper direction. Insert outside edge first, push down on inside edge to secure in place.

B2

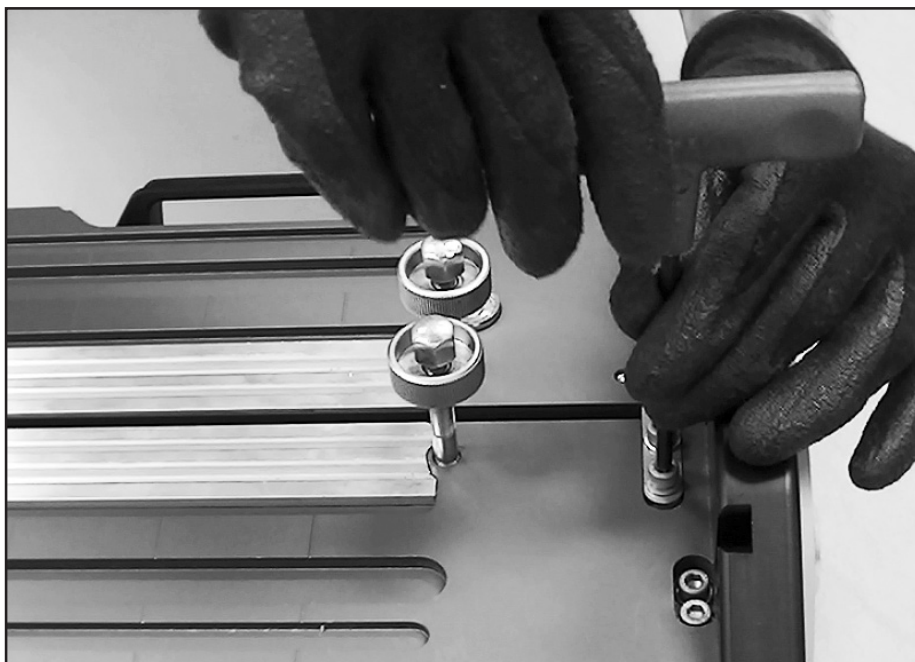

On platen stop plate, loosen two socket head cap screws using a 5 mm hex driver. Repeat for platen stop plate on opposite end of platens.

Platen Stop Set Up

B3



Position belt with drive bars engaged in both templates. Rotate actuating lever loosely between “Cut/Load” and “Splice” positions.

B4



Install and tighten belt clamp bars, ensuring belt drive bars are fully seated in templates.

Platen Stop Set Up

B5



Move platen stop plate to contact fixed platen face. Repeat for platen stop plate on opposite end of platens – move to contact blade holder.

B6



Tighten two socket head cap screws using 5 mm hex driver. Repeat for platen stop plate on opposite end of platens.

Platen Stop Set Up

B7



Remove clamp bars and belt.

Prepare Belt Ends for Splicing

C1

Ensure template and platen receiving slots are clean and debris-free.

C2

Ensure only one template is installed.

Prepare Belt Ends for Splicing

C3

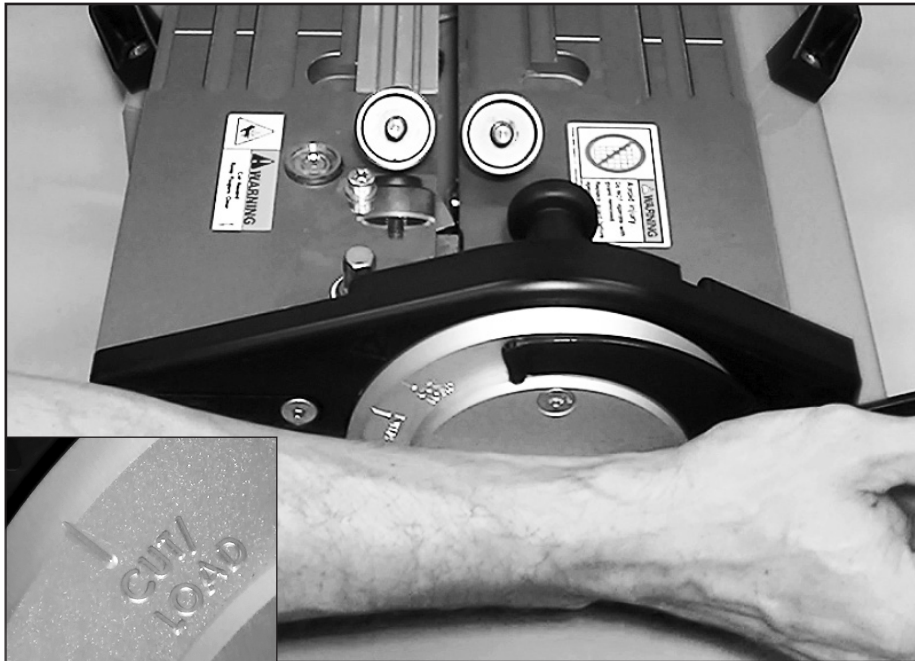

Rotate lever to cut/load position.

C4



Lock in place with locking pin.

Prepare Belt Ends for Splicing

C5

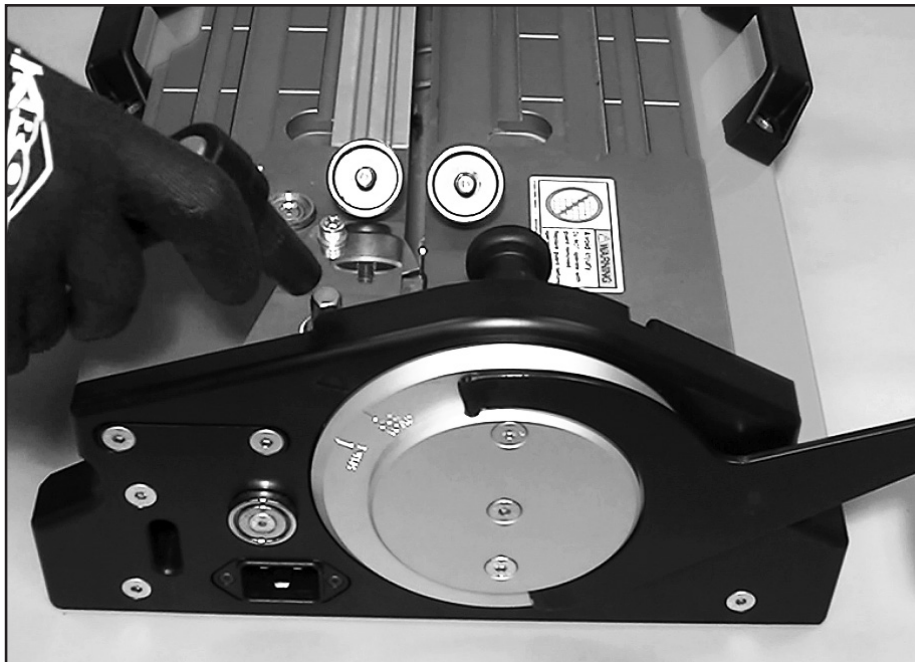

Engage cutter crank with cutter drive shaft.

C6

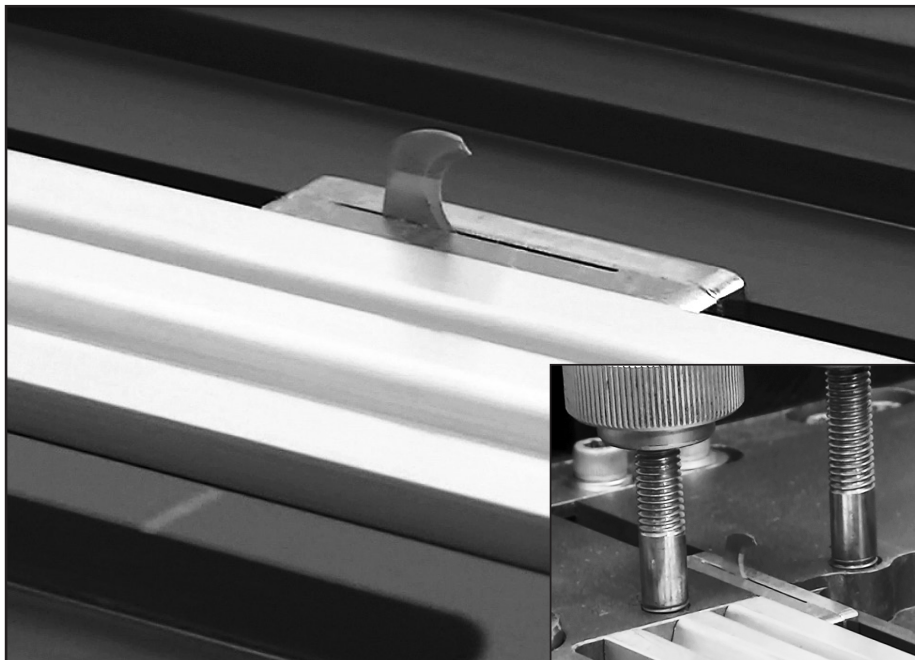

Drive cutter blade to machine side opposite controls. **Caution!** Use cut resistant gloves during cutting operation. Ensure blade is parked at full travel position of cutter, between clamp studs.

Prepare Belt Ends for Splicing

C7

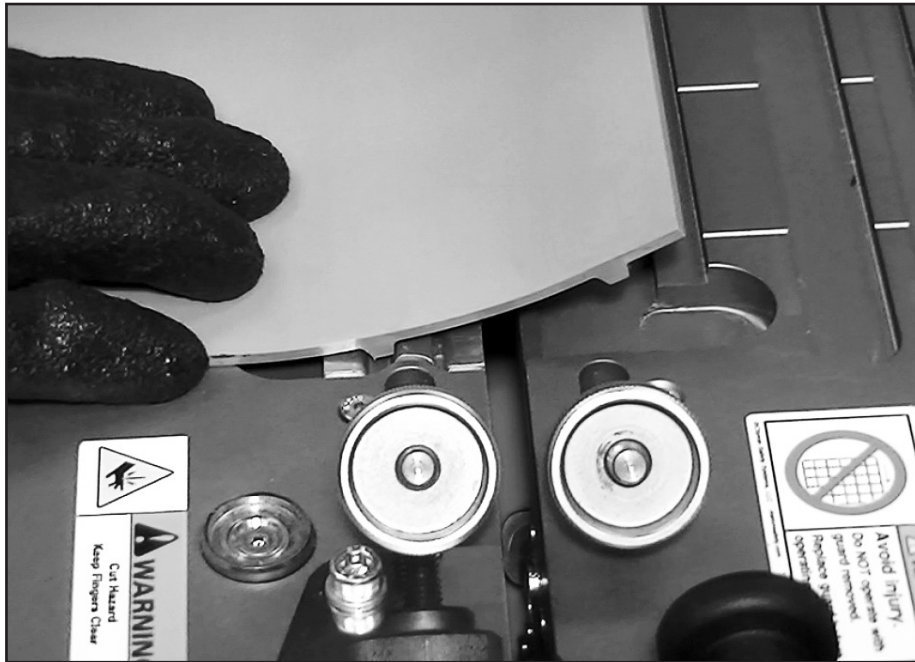

Engage belt with template. Position to cut out a problem belt area, or to simply prepare belt end with a precise cut for splicing. Belt must fully cover gap between platens. **Note!** Only belt ends prepared with the integrated cutter are sufficiently accurate to accommodate splicing.

C8



For tension-driven flat belt or positive drive belts with segmented drive features, a preferred practice is to use Flexco Friction tape (Item No. 08604) installed on clamp bars. Friction tape assists in fixing the belt position during the cutting and splicing operations. A damp cloth can be used to clean the friction tape surface.

FLEXCO

Prepare Belt Ends for Splicing

C9



For positive drive belts, a preferred practice is to position belt fully against template end nearest controls. This may provide additional lateral (belt width) support to resist cutting loads.

C10



Install one clamp bar tightly over installed belt and template.

Prepare Belt Ends for Splicing

C11

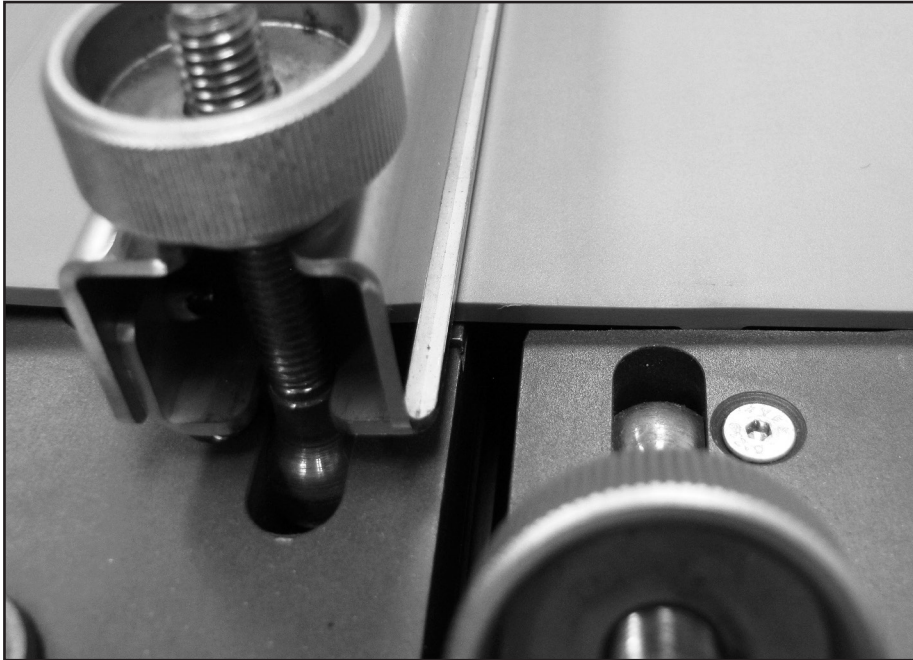

Clamp Bar orientation. “Balance” clamp load evenly when tightening clamp thumb nuts. This balanced load is particularly important when preparing tension-driven flat belt or belt possessing separated drive features. ALWAYS TEST FOR UNIFORM CLAMPING by pulling the belt. If belt slip is observed, readjust clamping thumb nuts to balance load. Clean friction tape surface as required assist in preventing slip.

C12

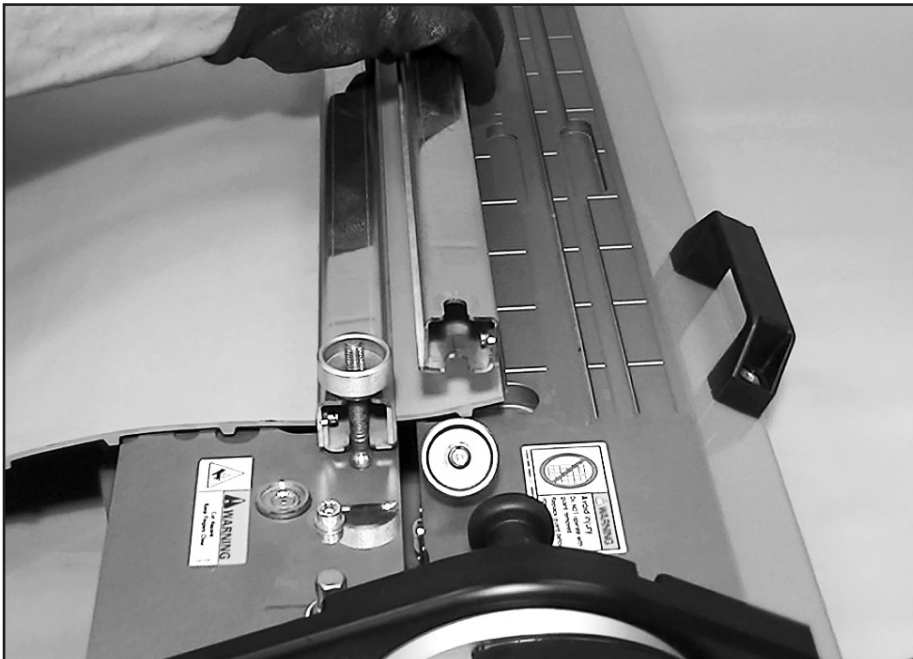

Loosely clamp remaining belt clamp bar. DO NOT TIGHTEN CLAMP BAR. This clamp bar is installed to provide protection from cutter blade. It is important that belt relief is allowed on loosely clamped side of cutting blade during cutting process.

Prepare Belt Ends for Splicing

C13

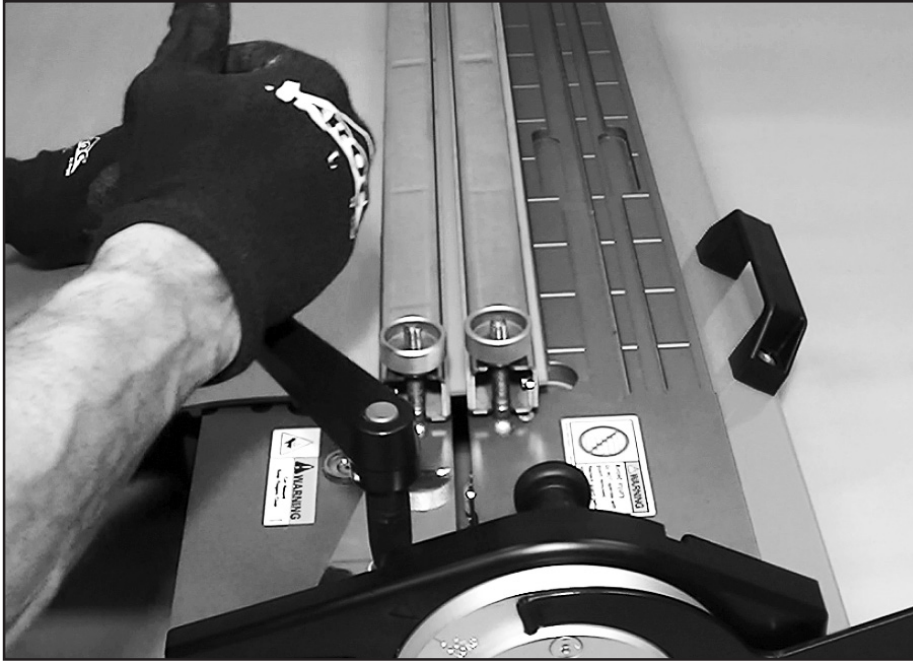

Using cutter crank, apply consistent cranking speed to draw cutting blade toward control end. **Important!** Do not stop cutting action, particularly when blade is entering or exiting belt. Failure to comply will result in an uneven cut.

C14



Support belt to prevent belt from “peeling away” during cutting. Failure to comply will result in an uneven cut where blade exits from belt. **TIGHTLY CLAMPED** side of belt is now prepared for splicing.

Prepare Belt Ends for Splicing

C15

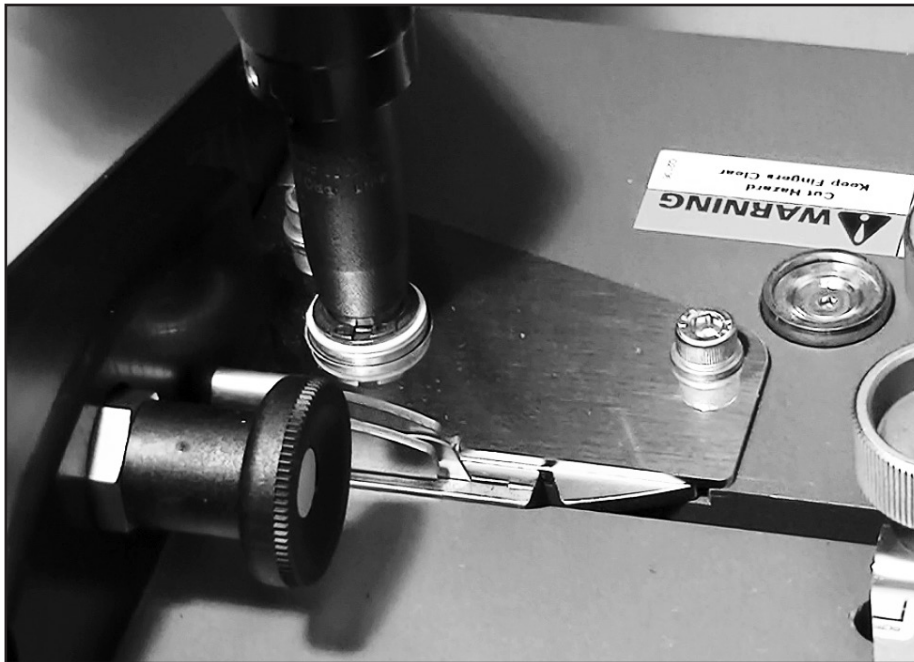

Continue cranking until blade arrives in its stowed position and cutter position latch is activated.

C16



Relax clamp thumb nuts and remove clamp bars. Move prepared belt end clear of machine.

Prepare Belt Ends for Splicing

C17



Relocate belt template to opposite platen. Repeat belt end preparation on second belt end (Steps C7 through C16).

Prepare for Splice

D1

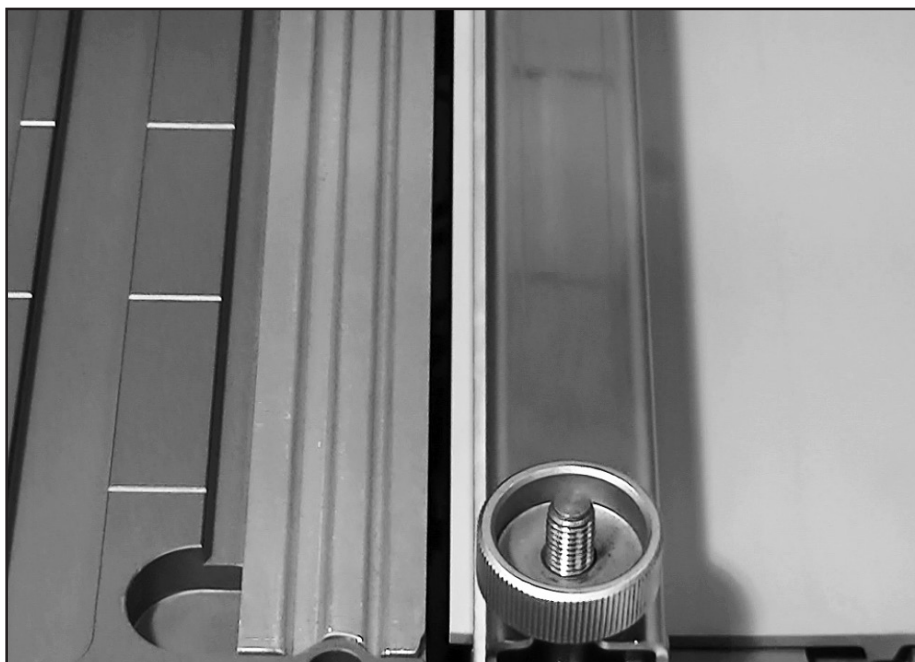

Ensure appropriate matched set of templates are installed in machine.

D2



Ensure belt is positioned “square” to machine by either engagement of positive drive feature, or by using a square or alignment marks. **Note!** Belt should be centered in machine for splicing.

Prepare for Splice

D3



Load belt ends, aligning edges of prepared belt.

D4

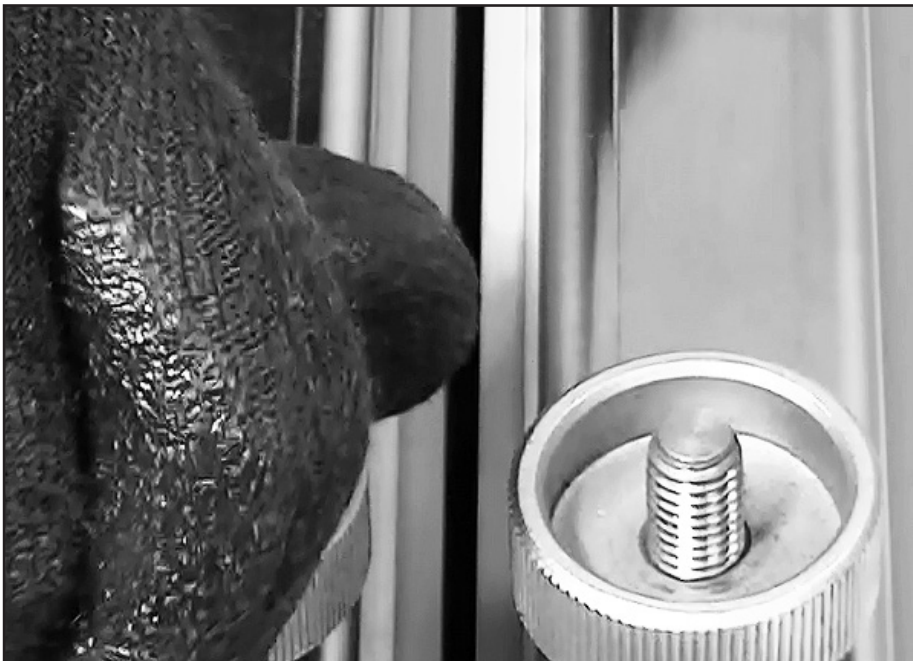

Clamp prepared belts in machine using clamp thumb nuts, ensuring uniform clamping pressure across belt width.

Prepare for Splice

D5



With both prepared belt ends clamped in machine, pull out and rotate locking pin to release it from locked position. **Note!** The pin is positioned as to not restrict actuator lever movement during splicing.

D6

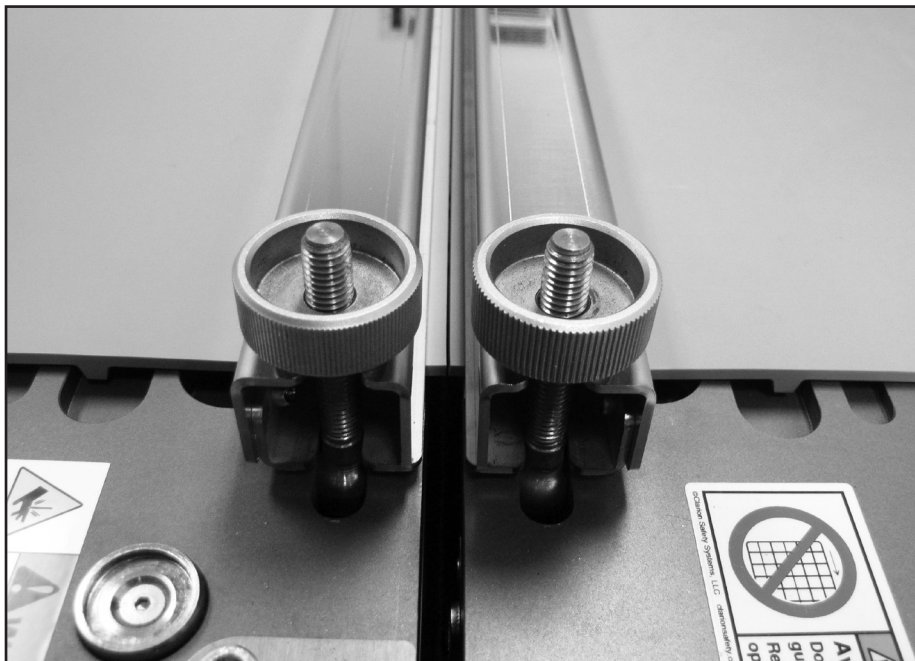

Position actuator lever to permit prepared belt ends to abut. There should be no more than approximately 0.1 mm (.004") gap along entire abutted faces. If gap is greater or uneven, it may be necessary to reprepare belt ends.

Prepare for Splice

D7

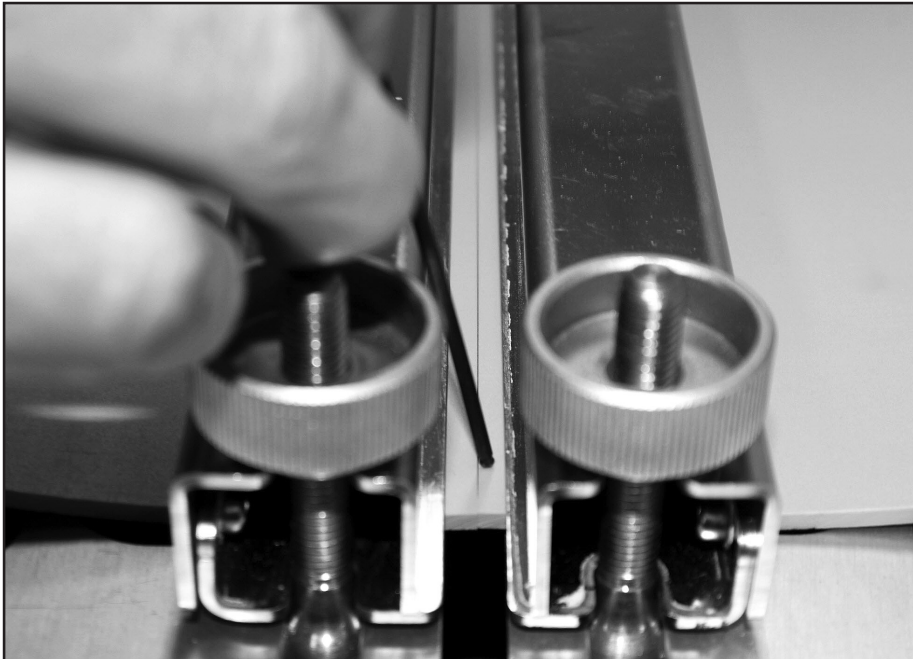

Using 2 mm ball driver provided, or an alternate “probe,” determine by feel if prepared belt ends are uniformly aligned “vertically.” No “step” should be felt when moving probe across cut length. If a step is recognized, attempt alignment of belt surfaces via tightening (or loosening) clamp thumb nuts.

D8



If belt surface cannot be aligned by thumb nut tension, fixed platen can be adjusted using two jacking screws. Ensure jacking screws are locked into position, using associated jam nuts once belt surface alignment is achieved.

Splice

E1



Install guard and ensure magnetic engagements are secure and seated.

E2



Select proper power cable and plug into machine power inlet.

E3



Connect power cable to supply power outlet.

E4



Open platens and raise emitter into heating position using actuator lever.

E5



Place heating mode switch to PREHEAT position.

E6



Set desired preheat time (in seconds) on timer.

Splice

E7



Press green start switch.

E8



Allow preheat period to expire. A sound tone will be heard at conclusion of preheat cycle. Allow machine and belt to cool to preset "splice start" temperature.

Splice

E9



During this cooling period, set heating mode rocker switch to SPLICE position.

E10

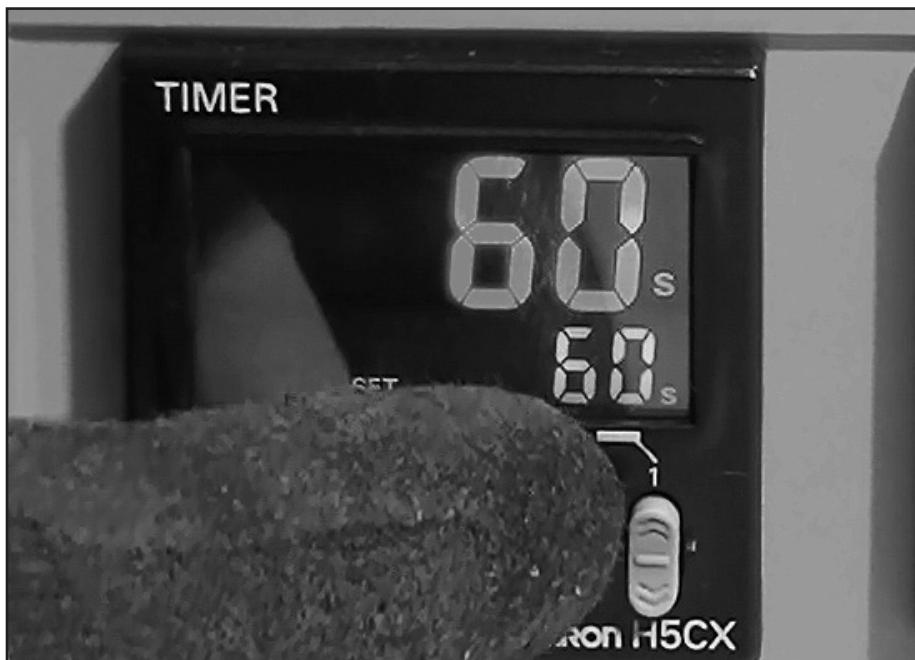

Set desired splice time on timer.

Splice

E11



Factory preset “splice start” temperature is 40°C. A white light on start/stop switch will illuminate when control temperature is at or below setting.

E12



When machine cools to “splice start” temperature and light illuminates, immediately press green start button to initiate splice heating cycle. Closely attend machine during splice cycle.

E13



An audible signal tone marks the conclusion of the splice heating cycle. Immediately (within 1 second) at tone, rotate actuator lever to splice position and hold for approximately 5 seconds. Do not force actuator lever against internal stop.

E14



Allow machine to cool until white light illuminates (factory setting 40°C control temperature). **Warning!** Guard, clamp bars, and clamping thumb nuts are hot after splicing. It is important for safety and for splice integrity that the machine is allowed to cool after splice is made.

Splice

E15



After light signal indicates conclusion of splice process, remove guard.
Caution! Guard, clamp bars, and clamping thumb nuts remain hot after end of process indication.

E16



Remove clamp bars. **Caution!** Clamp bars may be hot.

Splice

E17

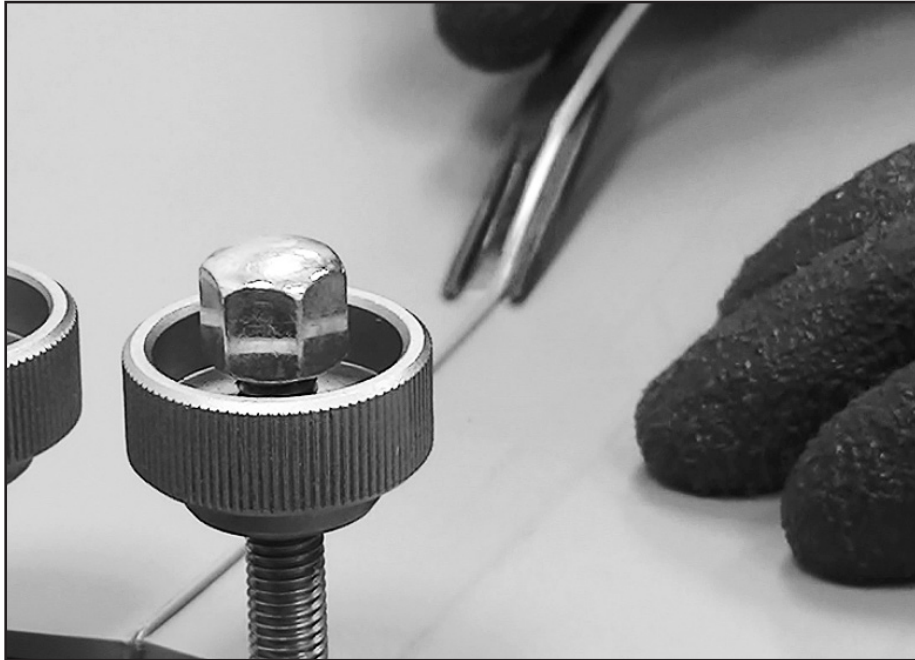

Remove weld bead from top side of belt with skiving tool. This is best accomplished while belt remains on machine with edge positioned against the vertical clamp studs.

E18

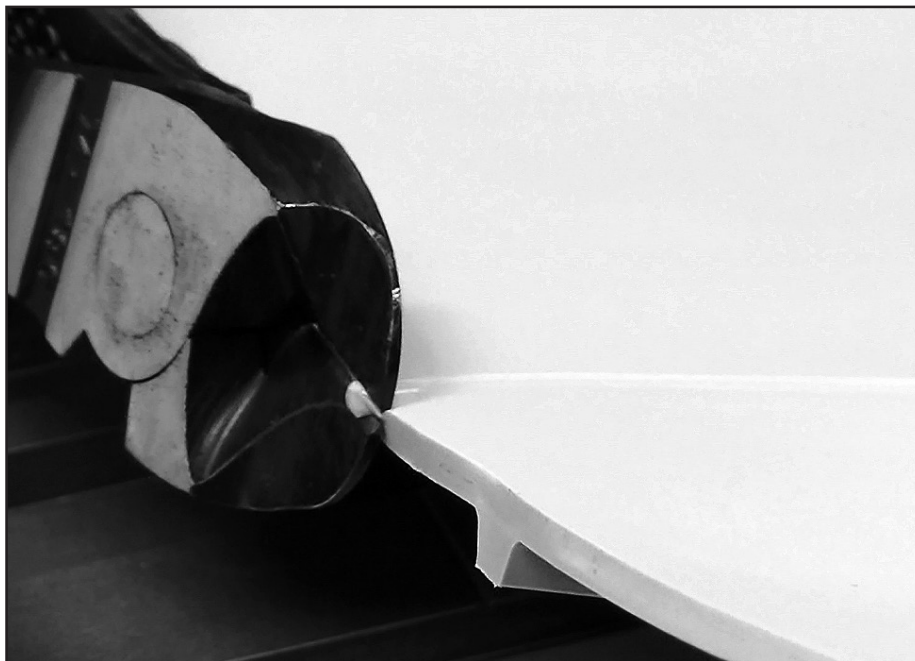

Trim splice weld bead from belt edges using Flexco Unibar cutter.
Note! Spliced belt widths may vary. If necessary, cut taper lead on any edge, removing any “steps” from belt edges.

E19



Remove underside weld bead with skiving tool.

Operating Parameters

Note! These parameters are provided as guidelines. It is strongly recommended that operators develop splice parameters based on experience.

PREHEAT Time	
Ambient Temperature	PREHEAT Minutes*
21° to 40°C (70° to 104°F)	≥5
0° to 20°C (32° to 68°F)	≥5
-20° to -1°C (-4° to 30°F)	10-15

- 120°C PREHEAT temperature (Preprogrammed)
- PREHEAT is always recommended to remove moisture from belt
- *Recommendation for 3 mm belt thickness

SPLICE Time		
Belt Material	Start Temperature	SPLICE Seconds*
Polyurethane	40°C (104°F)	50 - 60
Polyurethane	20°C (68°F)	65 - 70
Polyester	40°C (104°F)	70 - 75
Polyester	20°C (68°F)	TBD

- Appropriate process development for “splice start” temperatures below 20°C (68°F) should be developed by operator.
- *Recommendation for 3 mm belt thickness

Operating Condition of Acceptability (COA)

The following are considered extreme cyclic splice processes* based on use at 40°C (104°F) ambient:

PREHEAT	Cooling to	SPLICE	Cooling to	Non-Use	Repeat
15 Minutes	50°C (122° F)	80 Seconds	50°C (122° F)	5 Minutes	

*Note: The Amigo® has not been tested in conditions which exceed these settings.

Service and Maintenance

General Safety Rules

DANGER!

- Only qualified repair personnel must perform machine service. Service or maintenance performed by unqualified personnel could result in injury.
- Do not modify equipment, including the electrical circuit.

CAUTION!

- Maintain machines with care. Only use sharp and clean blades. Properly serviced machines and blades with sharp edges are less likely to bind or damage material and are easier to control.
- When servicing a machine, use only original replacement parts. Use of unauthorized parts or failure to follow Maintenance Instructions may create a risk of injury.

Replacing Cutting Blade

WARNING!

- Always wear cut-proof safety gloves and safety glasses when replacing blade. Blade is razor sharp; treat it accordingly.
- Stow spare blades safely.
- Do not attempt to resharpen blades. This will affect cutting accuracy.
- Disconnect power when servicing.



1. Rotate actuator lever to SPLICE position.
Caution! Emitter is exposed during operation. Use caution to avoid damage.

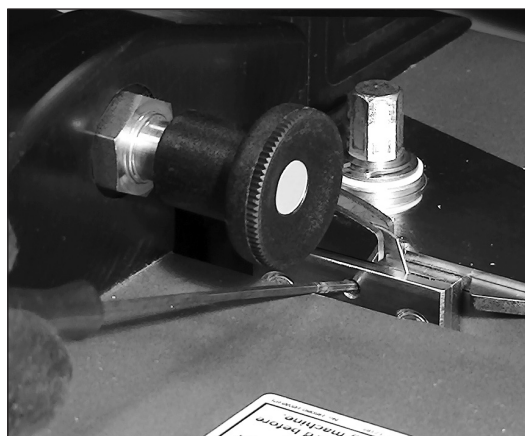

2. Using the 2 mm ball driver provided, loosen blade retention set screw **1 turn MAXIMUM**.
Caution! DO NOT loosen excessively. Set screw is very short and can become disengaged and lost.

Replacing Cutting Blade (continued)

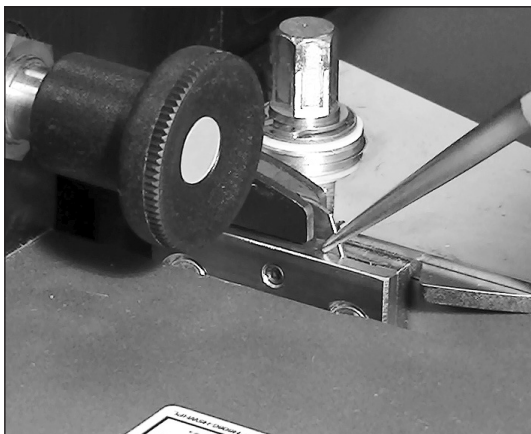

3. Using pliers, remove blade from blade holder.

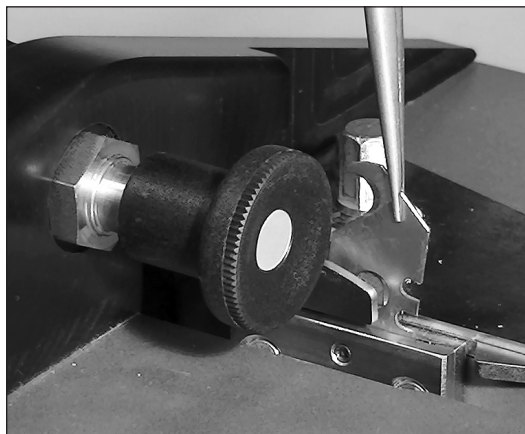

4. Install new blade or rotate blade to use opposite unused cutting side. **Warning!** Use only blades provided by Flexco. Blades are slightly modified as compared to stock blades.

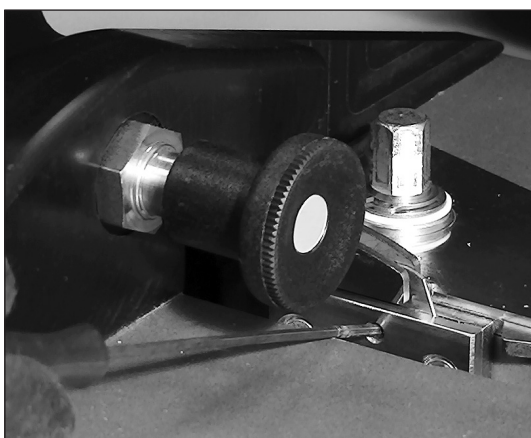

5. Ensure blade is properly seated in blade holder. Tighten blade retention set screw.



6. Rotate actuator lever/cam disk to close platens.

Service and Maintenance

Replacing Emitter

WARNING!

- Disconnect Power supply! Machine must be disconnected from power during emitter replacement.
- Mechanical spring energy is contained in emitter spring tensioner system. Use care when removing and reinstalling emitter.

CAUTION!

- Do not damage emitter. Kinks or other defects will result in poor emitter performance.
- Do not damage, bend, or move temperature control thermocouple.
- Thermocouple position will require reverification after emitter replacement. Use 2 mm ball driver provided to verify 2 mm spacing between emitter and thermocouple.
- When loosening or tightening emitter retention nuts, resist torque load on copper emitter blocks to avoid bending emitter.

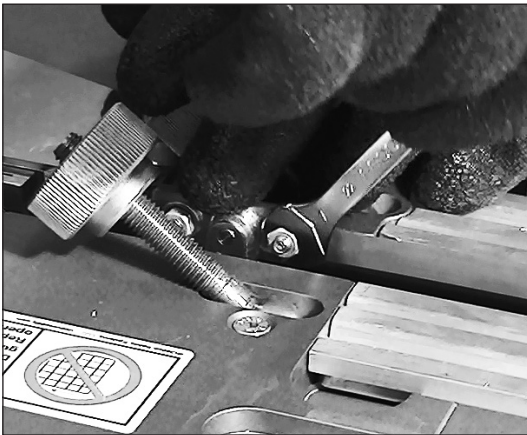

1. Using a 7 mm open end wrench, first remove emitter retention nut on spring tensioner side of machine. A Belleville washer resides between retention nut and emitter. Use care to avoid dropping nut or Belleville washer into machine. If parts are dropped into machine, see “CLEANING OF MACHINE” below, for removal of fixed platen, to allow access to machine internals.

3. Repeat for removal of fixed emitter mount side nut and Belleville washer.

4. Clean copper emitter mounting blocks using a small wire brush – preferably stainless steel or bronze bristles – to remove oxidation.



2. Once emitter retention nut and Belleville washer are removed, manually compress emitter spring tensioner and disengage emitter from emitter block retention stud.

5. **Note!** Replace emitter only with original Flexco retention nuts and Belleville washers. Retention nuts are silver plated to survive elevated temperatures. Zinc plating will degrade at high temperature conditions. Do not replace with stainless steel nuts since threads can gall, thus preventing emitter service. Belleville washers are made of a high temperature compatible stainless spring steel.

Replacing Emitter (continued)

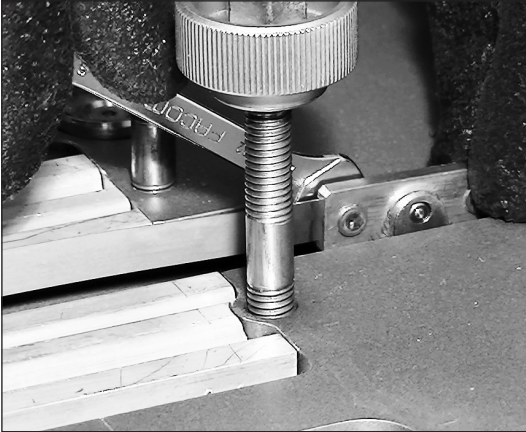

6. Install new emitter first on fixed emitter mount. Engage emitter mounting hole with copper emitter block mounting stud. Ensure emitter is seated in recess of copper emitter block. Install Belleville washer with large washer contact area side against emitter strip. Belleville washer must “cone out” to retention nut. Install retention nut completely against Belleville washer, ensuring all clearance is taken out. Resist torque loads on copper emitter block while tightening emitter retention nut. Ensure Belleville washer is fully compressed after tightening, and emitter is properly seated in emitter block recess.



7. Compress emitter spring tensioner to allow emitter mounting hole to be engaged with copper emitter block mounting stud.



8. **DO NOT RELEASE SPRING COMPRESSION.** Premature release of compression spring load may cause damage to emitter mounting hole. Ensure emitter is seated in copper emitter block recess. Install Belleville washer over mounting stud with large washer contact area side against emitter strip. Install retention nut and tighten to fully compress Belleville washer. Spring compression may now be released.

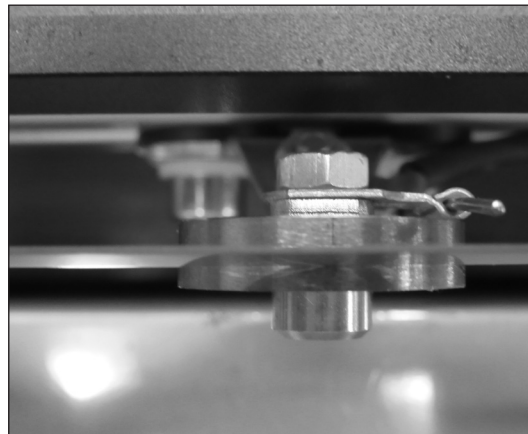

9. Ensure emitter is positioned on (or over) emitter support roller. **Note!** Emitter may possess a slight “bow” thus preventing initial contact with support roller. This will relax after several conditioning heat cycles. Ensure emitter is not in contact with thermocouple.

Replacing Emitter (continued)

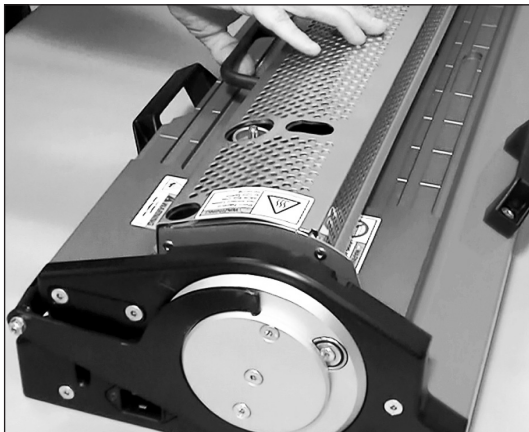

10. Install guard and operate 3 to 5, 70-second cycles on splice setting. Allow emitter to cool between cycles.



11. Remove guard. Using 2 mm ball driver, verify 2 mm clearance between emitter and thermocouple. This is the factory setting and should not change unless thermocouple is contacted during emitter replacement. Carefully adjust thermocouple only if necessary. Lightly press against thermocouple to adjust position. Thermocouple height is not adjusted.

Service and Maintenance

Cleaning Splicing Press

WARNING!

- Machine must be disconnected from power during cleaning.
- No open flame or ignition sources are to be near machine during cleaning.
- Ensure adequate ventilation exists during cleaning.
- Any use of alcohol for degreasing shall be limited only to amount necessary to lightly dampen cleaning cloth. Do not saturate cleaning cloth to permit dripping or pooling of alcohol.
- Do not apply alcohol to electrical components.
- Ensure machine is thoroughly dry and vapors are not present before powering machine.

Exterior Cleaning

- Wipe exterior surfaces with clean cloth. Use cloth lightly-moistened with alcohol to degrease exterior surfaces. Avoid alcohol contact with electrical components.

Interior Cleaning

Remove fixed platen to access inner portion of machine.

CAUTION!

- Avoid contact with emitter to prevent emitter damage.
- Ensure emitter is in stowed position prior to removal of fixed platen. Failure to comply may result in damage to reed switch.
- Do not remove sliding platen. If both platens are removed, a significant readjustment is required for proper platen installation.
- Remove—Clean—Replace one platen at a time to avoid significant set-up effort.



1. Loosen and remove four (4) platen locking screws.



2. Slide fixed platen back in front plate retention grooves.

Service and Maintenance

Interior Cleaning (continued)



3. Lift platen side located opposite control end.



4. Swing control end platen side out of front plate retention grooves. Place platen near machine.
Caution! A ground wire is attached to the fixed platen. Use caution to avoid damage to this wire and connection.

5. Using a clean vacuum, remove any debris from inside of machine.

6. Use a lightly-moistened alcohol cloth to degrease inside surfaces. Avoid alcohol contact with electrical components and wires.



7. Raise emitter to access beneath sliding platen for cleaning opposite side. Lower emitter after cleaning.



8. Replace fixed platen.

9. Reassemble opposite of disassembly.

Service and Maintenance

Interior Cleaning (continued)

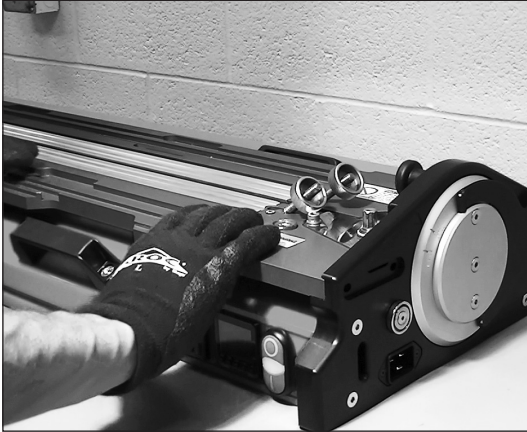

10. Lock actuating disc in cut/load position.



11. Crank blade holder just outside of stowed area.

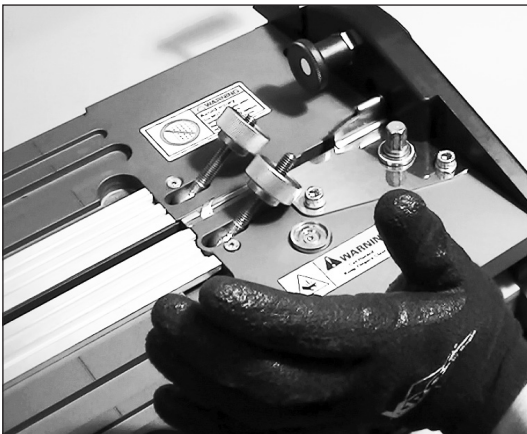

12. Move fixed platen lightly against blade holder.



13. Lightly tighten two (2) adjacent side platen locking screws.

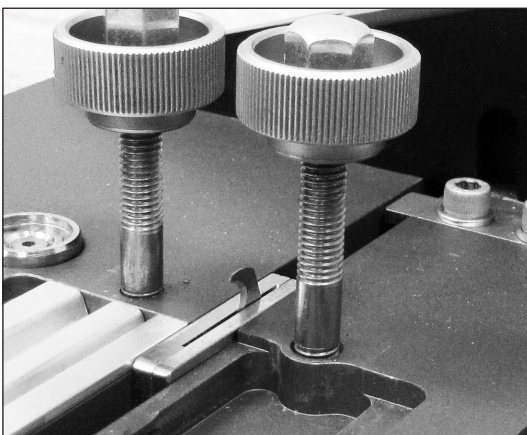

14. Crank blade holder fully to opposite side of machine.



15. Move fixed platen lightly against blade holder.

Service and Maintenance

Interior Cleaning (continued)



16. Fully tighten two (2) adjacent side platen locking screws.

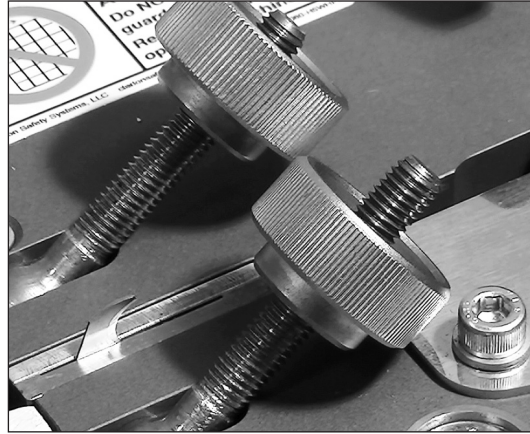

17. Crank blade holder back just outside of stowed area.



18. Loosen two (2) platen locking screws at control end.



19. Ensure fixed platen is lightly against blade holder.



20. Fully tighten two (2) adjacent side platen locking screws.

Thermostat Reset

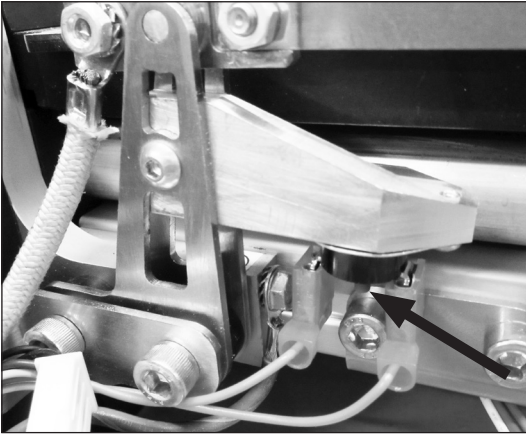

1. Using 3 mm allen wrench pull up to reset red button.

Emitter Life

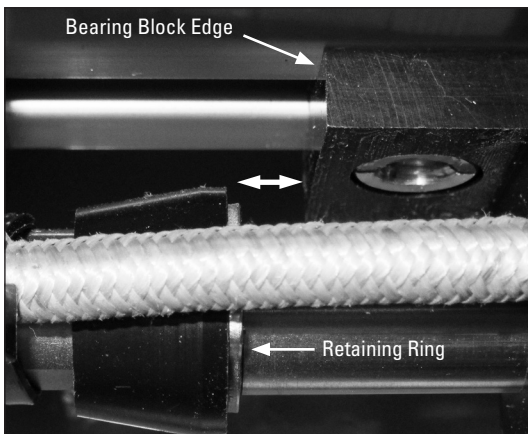

1. End-of-Emitter-Life retaining ring aligned with bearing block edge, when emitter is cold. Inspect emitter life indication in a "cold", power-off state. Image shown indicates significant emitter life remains. Emitter is at the end of its useful life when the "arrow" dimension is zero. Emitter must be replaced when the Retaining Ring is even with the Bearing Block Edge shown—in a cold, power-off state.

Troubleshooting

Indication	Possible Cause	Possible Solution
Bubbles evident in weld bead	Moisture in belt	Skive and inspect weld for pores.
		Increase preheat time.
	Overheating belt	Skive and inspect weld for pores.
		Ensure splice is initiated at "splice start" temperature as indicated by switch light.
Bubbles evident in skived splice	Moisture in belt	Reduce splice time.
		Increase preheat time.
	Overheating belt	Ensure splice is initiated at "splice start" temperature as indicated by switch light.
Discolored—tan / brown splice	Belt not cleaned prior to splice	Reduce splice time.
		Clean belt.
	Overheating belt	Ensure splice is initiated at "splice start" temperature as indicated by switch light.
Uneven top belt surface across splice	Clamp bars not uniformly tightened	Adjust clamp bar thumb nuts to match upper belt surfaces across abutting cut belt edges. Note—between each adjustment, relieve abutting cut face contact using actuator handle. Otherwise abutting faces may "stick" and not respond to adjustment.
	Fixed platen height not adjusted	Adjust fixed platen height using jack screws and lock nuts. Verify after lock nuts are tightened.
Positive drive feature pitch too narrow or too great	Platen stop not positioned properly	Adjust platen stop to increase or decrease pitch spacing.
	Cutting procedure	Ensure proper cutting procedure is followed.
Excessive time to achieve 120°C Preheat temperature Ambient (+20C) < 4 minutes Ambient (-20C) < 10 minutes	Thermocouple too distant from emitter	Ensure emitter strip is positioned on white support roller.
		Refer to emitter replacement section regarding thermocouple/emitter spacing.
Emitter disengages from support roller after splice	Emitter has exceeded its intended life	Replace emitter.
Reduced weld bead size down length of splice	Emitter distortion	Replace emitter.
		Increase splice time approximately 5 seconds to increase melt of least fused end.
		Shim belt template upward approximately 1.5 mm on reduced weld side.
	Emitter has reached its intended life	Refer to emitter replacement section. Remove and rotate emitter end-for-end. Run approximately 10 no-belt splice cycles to recondition emitter.
Emitter/Platen spacing not uniform	Replace emitter.	Measure emitter/platen distance at each end—both platens. Adjust so all 4 positions are within 0.1 mm
Uneven weld bead—general	Uneven cut / belt slip during cut	Ensure proper cutting procedure is followed.
		Ensure blade holder does not display excessive clearance in any position down length of platen. Adjust fixed platen if necessary to reduce blade holder clearance. Blade holder should be well guided but not tight.
		Ensure belt does not slip beneath clamp bars during cut. Follow proper clamping and cutting procedure. Use Flexco Traction Tape (Item 08604) on clamp bars if necessary.
		Dull Blade—Replace blade.

Troubleshooting

Indication	Possible Cause	Possible Solution
Uneven weld bead—general	Belt slip during splice	Follow proper clamping procedure. Use Flexco Traction Tape (Item 08604) on clamp bars.
Cut face not square to belt product surface	Template installed and/or belt clamped on “non-splice side” of cut	Follow proper cutting procedure.
	Belt possesses excessive rolled “memory”	Attempt reverse rolling belt to relax rolled “memory.”
Splice “gull-wing” shaped after weld	Belt possesses excessive rolled “memory” resulting in gull-wing positioning during splice operation.	Attempt reverse rolling belt to relax rolled “memory.”
	Excessive weld “clash” or engagement	Increase splice heating time. Set platen stop to reduce clash.
Heating cycle/Timer will not initiate	Guard not seated in position	Check for timer “RST” light. If illuminated, heating cycle will not start. Reseat guard magnetic retainers into platen disks.
	Guard in position—Emitter not in heating position.	Check for timer “RST” light. If illuminated, heating cycle will not start. Rotate actuator handle to heating position.
Heating cycle does not initiate Timer functioning	Thermostat tripped	Reset thermostat
No power	Cable connection	Verify power cable is connected to machine and to supply power outlet of proper capacity.
	Power supply circuit breaker tripped	Evaluate total circuit load and capacity based on machine power requirements and other equipment sharing this circuit.
Actuator disk locks during “rotate to splice” position	Cut position locking pin not fully in disengaged and retained	Pull cutter locking pin back. Rotate to ensure pin is fixed in disengaged position.
Fiber reinforcement exposed after weld NOTE—successful splice consistency for this belt construction is not assured	Excessive weld “clash” or engagement	Set platen stop to reduce clash.
	Belt possesses excessive rolled “memory”	Attempt reverse rolling belt to relax rolled “memory.”
	Cutter blade insufficiently sharp to cleanly cut fiber	Install new cutter blade.
Condensation on machine	Machine removed from cold controlled ambient to warm/moist ambient conditions.	Upon completion of splice activity, place sufficiently cooled machine in transport case and close. Ideally, transport case is at cold controlled ambient conditions when closed.



Schematics

Schematics - Amigo 625

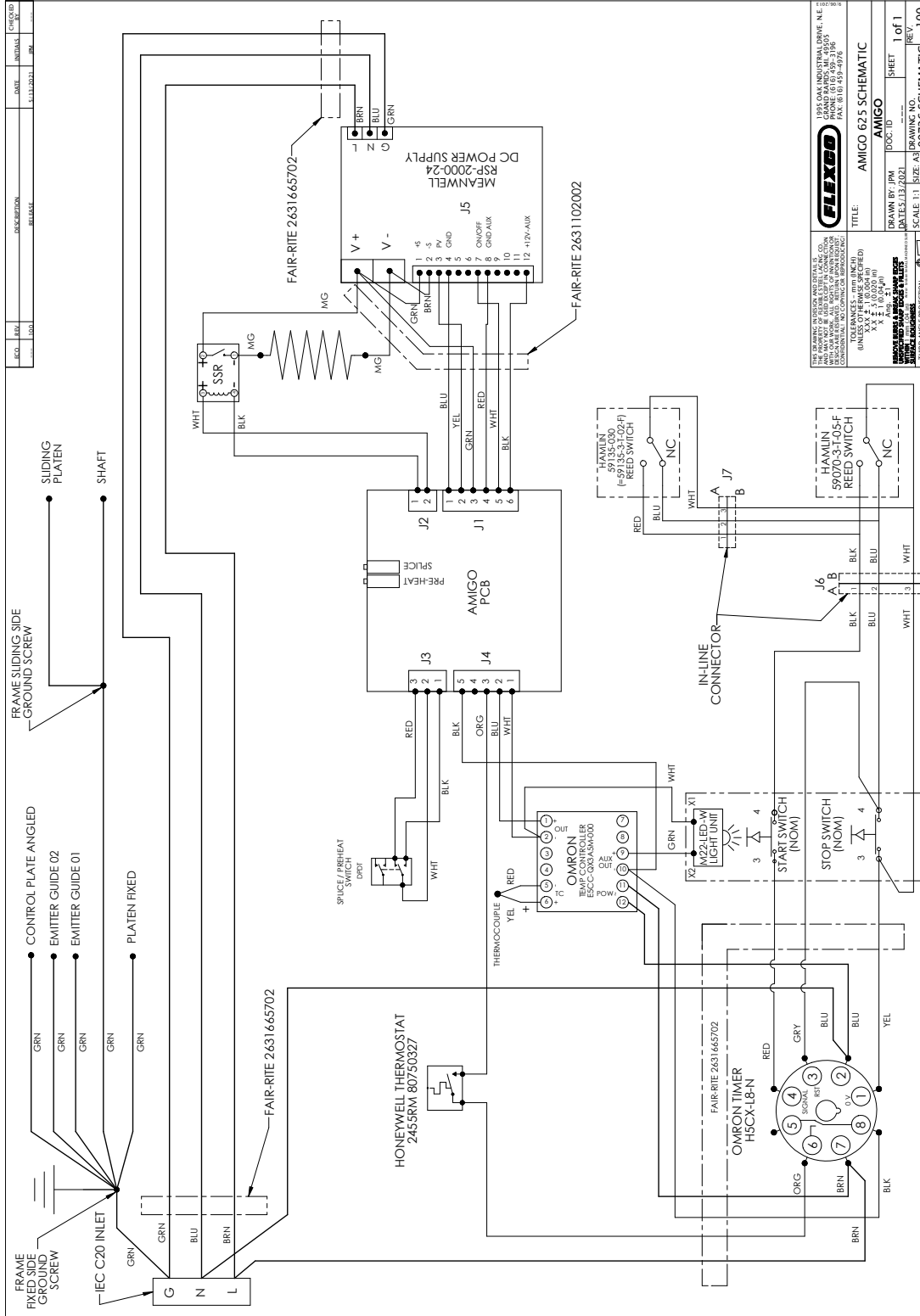

<p>THE DRAWING IS AN UNCONTROLLED COPY. IT IS NOT TO BE USED FOR CONSTRUCTION OR REPAIR WORK UNLESS IT IS THE ORIGINAL DRAWING. ANY CHANGES TO THE ORIGINAL DRAWING MUST BE APPROVED BY THE ORIGINAL DRAWING ENGINEER.</p> <p>UNITS: DIMENSIONS IN INCHES UNITS: DIMENSIONS IN MILLIMETERS X 1/8 ± 0.004 (in) X 1/16 ± 0.002 (in) X 3/32 ± 0.004 (in)</p>	<p>1971 OSA INDUSTRIAL DRIVE, N.E. GRAND RAPIDS, MI 49505 TEL: (616) 961-1111 FAX: (616) 959-8976</p>
<p>FLEXCO</p>	<p>TITLE: AMIGO 625 SCHEMATIC</p>
<p>DRAWN BY: JPM</p>	<p>DOC. ID: AMIGO</p>
<p>SCALE: 1:1</p>	<p>SHEET 1 of 1</p>
<p>THIRD ANGLE PROJECTION</p>	<p>DRAWING NO. 007226 SCHEMATIC</p>



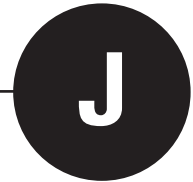

Replacement Parts

DANGER!

- Service shall only be performed by a qualified electrician. Disconnect external power supply from machine before service. Stored mechanical energy exists in emitter tensioning system. Follow Lock-Out Tag-Out procedures. Observe proper maintenance procedures. Do not modify electrical circuit.
- **Note!** Residual electrical power exists for a time after external power supply is disconnected. DO NOT SERVICE until power supply fully discharges. Wait until controller displays show no power and go dark.

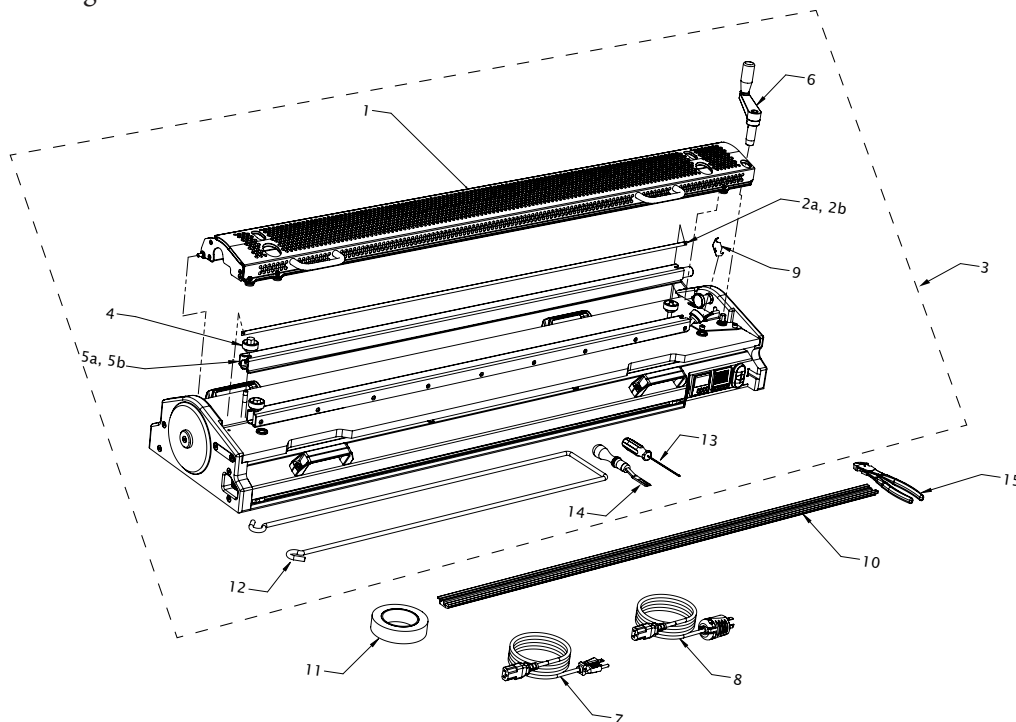

Call Out	Item ID	Description
1	08543	AMIGO-1000-GUARDASSY
2a	08544	AMIGO-1000-EMITTER-KIT
2b	09741	AMIGO-625-EMITTER-KIT
3	08545	AMIGO-1000-SPLICEPRESS
4	08569	AMIGO-1000-KNURLDKNOB8
5a	08572	AMIGO-1000-CLAMPBAR
5b	09742	AMIGO-625-CLAMPBAR
6	08575	AMIGO-1000-CRANKHANDL
9	08587	AMIGO-1000-BLADES-5
10	See page 52, 53 and 54	
11	08604	AMIGO-1000-FRICTIONTAPE-33X25
12	08611	AMIGO-CASE-TOW-HANDLE
13	08618	AMIGO-HEXDRIVER-2MM
14	03239	RTBS SKIVER
15	03445	CUTTER-UNIBAR

NOTE: Amigo 625 replacement part needs, contact Flexco Customer Service.

Call Out	Item ID	Description	
7	08585	AMIGO-1000-CABLE-1X115-IEC520	
7	08586	AMIGO-1000-CABLE-1X230-IECL620	
8	08588	AMIGO-1000-CABLE-1X230-IECBR3	
8	08707	AMIGO-1000-CABLE-1-X230-CEE77	
8	08708	AMIGO-1000-CABLE-1X230-CH2-16P	
8	08718	AMIGO-1000-CABLE-1X230-BS1363	
8	08727	AMIGO-CABLE-1X230-AS3112	

Replacement Parts

Amigo™ 1000 Belt Template Ordering Information

Item Code	Ordering Number	Belt Manufacturer	Belt Style	Belt Type
08592	AMIGO-1000-TMPLT-08592	Ammeraal Beltech	Soliflex CB	TPU
		Intralox®	ThermoDrive®	8140 Dual Lug
		Volta	SuperDrive™	FMW & FMB FHW & FHB
08593	AMIGO-1000-TMPLT-08593	Intralox®	ThermoDrive®	8050 8026
		Mafdel	DEL/DRIVE	DD25
08594	AMIGO-1000-TMPLT-08594	Habasit	Cleandrive™	CD.M50.S-UA.CB CD.M50.S-UA.WB CD.M25.S-UA.CB CD.M25.S-UA.WB
08595	AMIGO-1000-TMPLT-08595			Flat
08596	AMIGO-1000-TMPLT-08596	Forbo	Fullseal	PD1 U30 & PD2 U34
		Gates® TPU	PosiClean®	PC10 PC20
		UBR	1" Purclean	PS2 & PB3
08597	AMIGO-1000-TMPLT-08597	Beltservice Corporation	ProClean Center Drive Lug	PCCDB PCCD-MD
		Forbo	Fullseal	CD40- U34
		Gates® TPU	CenterClean®	CC40
		Habasit	CD M40	L-UA WB
		UBR	Center Drive PurClean	CD3BLSS
		Yongli Belting	HygienePro™	U400
08603	AMIGO-1000-TMPLT-08603	Ammeraal	Aeon	Aeon-50
08710	AMIGO-1000-TMPLT-08710	Cog-veyor Systems Inc.	Cog-veyor	UBM
				UWM
				PBH
				PWH
08739	AMIGO-1000-TMPLT-08739	Beltservice Corporation	Magnethane™	PD1
		Yongli Belting	HygienePro™	U300
08741	AMIGO-1000-TMPLT-08741			Flat w/Spikes
08776	AMIGO-1000-TMPLT-08776	Gates® TPU	PosiLace™	PC20 CC40 FC12
				UBR
08788	AMIGO-1000-TMPLT-08788	Ammeraal Beltech	Soliflex FB/mini FB	TPU
		Beltservice Corporation	ProClean 1" & 2" Pitch Drive Bar	PCPD2B PCPD1B-MD
		INO Belt	REOclean	REO-T50 REO-T25
		UBR	2" Purclean	PS2 & PB3
		Volta	DualDrive™	FMW & FMB FHW & FHB
			Mini DualDrive™	FMB FHB
			Mini SuperDrive™	FMB FHB
		08847	AMIGO-1000-TMPLT-08847	Volta
08849	AMIGO-1000-TMPLT-08849	Ammeraal Beltech	Soliflex PRO/ Soliflex PRO mini	Soliflex TPU Soliflex TPE
08855**	AMIGO-1000-TMPLT-08855	Mafdel	POSITIVEBELT	P02-L
08856	AMIGO-1000-TMPLT-08856	Mafdel	DEL/DRIVE	DD50
105846	AMIGO-1000-TMPLT-105846	Yongli	HygienePro™	U200
109228*	AMIGO-1000-TMPLT-109228	INO Belt	REOclean	AT40
109508*	AMIGO-1000-TMPLT-109508	INO Belt	REOclean	M25DB
109629*	AMIGO-1000-TMPLT-109629	INO Belt	REOclean	M5DB

*Must be spliced using the Return Side Kit 107322. 109228 use Return Side Kit when belt width is 39-1/4" or wider.

**The first three rows of lugs need to be trimmed prior to cutting and splicing the belt.



Replacement Parts

Amigo™ 625 Belt Template Ordering Information

Item Code	Ordering Number	Belt Manufacturer	Belt Style	Belt Type
09731	AMIGO-625-TMPLT-08592	Ammeraal Beltech	Soliflex CB	TPU
		Intralox®	ThermoDrive®	8140 Dual Lug
		Volta	SuperDrive™	FMW & FMB FHW & FHB
09730	AMIGO-625-TMPLT-08593	Intralox®	ThermoDrive®	8050 8026
		Mafdel	DEL/DRIVE	DD25
09732	AMIGO-625-TMPLT-08594	Habasit	Cleandrive™	CD.M50.S-UA.CB CD.M50.S-UA.WB CD.M25.S-UA.CB CD.M25.S-UA.WB
09733	AMIGO-625-TMPLT-08595			Flat
09734	AMIGO-625-TMPLT-08596	Forbo	Fullseal	PD1 U30 & PD2 U34
		Gates® TPU	PosiClean®	PC10 PC20
		UBR	1" Purclean	PS2 & PB3
09735	AMIGO-625-TMPLT-08597	Beltservice Corporation	ProClean Center Drive Lug	PCCDB PCCD-MD
		Forbo	Fullseal	CD40- U34
		Gates® TPU	CenterClean®	CC40
		Habasit	CD M40	L-UA WB
		UBR	Center Drive Purclean	CD3BLSS
		Yongli Belting	HygienePro™	U400
09736	AMIGO-625-TMPLT-08710	Cog-veyor Systems Inc.	Cog-veyor	UBM
				UWM
				PBH
				PWH
09737	AMIGO-625-TMPLT-08776	Gates® TPU	PosiLace™	PC20 CC40 FC12
				UBR
		09738	AMIGO-625-TMPLT-08788	Ammeraal Beltech
Beltservice Corporation	ProClean 1" & 2" Pitch Drive Bar			PCPD2B PCPD1B-MD
INO Belt	REOclean			REO-T50
INO Belt	REOclean			REO-T25
UBR	2" Purclean			PS2 & PB3
Volta	DualDrive™			FMW & FMB FHW & FHB
	Mini DualDrive™			FMB & FHB
	Mini SuperDrive™	FMB & FHB		
09739	AMIGO-625-TMPLT-08847	Volta	Hinge Splice	M (2.5-5mmH)
105844	AMIGO-625-TMPLT-105846	Yongli	HygienePro™	U200
109226	AMIGO-1000-TMPLT-109228	INO Belt	REOclean	AT40
109506*	AMIGO-625-TMPLT-109508	INO Belt	REOclean	M25DB
109627*	AMIGO-625-TMPLT-109629	INO Belt	REOclean	M5DB

*Must be spliced using the Return Side Kit 107323.

Amigo™ Return Side Splicing Ordering Information

The Return Side splicing kit includes components to enable splicing with the Amigo on the return side of the conveyor.

Amigo™ Return Side Kits		
Item Code	Ordering Number	Maximum Belt Width
107322	AMIGO-1000-RETURN-SIDE-KIT	1046mm (41.18")
107323	AMIGO-625-RETURN-SIDE-KIT	614mm (24.17")
107321	AMIGO-RS-GUARD-ADAPTER-KIT*	

*Contact Flexco Customer Service with your Amigo™ Serial Number to determine if this kit is required. Amigo™ Return Side is not compatible with the following belt templates: 08710, 08776, 08847, 09736, 09737, 09739.

Replacement Kits	
Item Code	Ordering Number
107324	AMIGO-1000-RS-FLAT-TMPLT
107325	AMIGO-625-RS-FLAT-TMPLT
107164	AMIGO-625-RS-CLAMPBAR
107183	AMIGO-1000-RS-CLAMPBAR



Warranty

Warranty provided is limited to defects in materials and workmanship.

The warranty has a maturity of one year from the date of delivery. In this period, the necessary parts will be made available free of charge. Any further warranty claims, damages, consequential damages are excluded.

The above warranty shall apply exclusively and only under the following conditions:

- An expert according to the conditions and standards of the competent authorities must install the appliance.
- Any warranty claims are forfeited when performing repairs, modifications, or adaptations and or assembling unapproved components without the prior consent of Flexco. In addition, any warranty claims are forfeited when installed by way of deviation from the national and local regulations.
- Claims during the warranty period provide no extension of the warranty period.

WEEE

Flexco takes WEEE compliance very seriously. This equipment is intended to be repairable in foreseeable circumstances. Should product disposal be required, contact Flexco Europe at 011-49-7428-9406-0 or Flexco UK at 011-44-1274-600-942.

EU DECLARATION OF CONFORMITY

Product: AMIGO 625 & 1000 Splice Press

Manufacturer: Flexible Steel Lacing Co. (Flexco)
1854 Northridge Dr. NW
Walker, Michigan 49544

European office: Flexco Europe
Leidringer Strasse 40-42
D-72348, Rosenfeld Germany
Telephone 49-7428-9406-0

This declaration of conformity is issued under the sole responsibility of the manufacturer.

Object of this declaration:

AMIGO 625 & 1000 Splice
Press Other colors apply.



The object of the declaration described above is in conformity with
the relevant Union harmonization legislation.

Conforms to European Directives:

2006/42/EC
2014/30/EU
2011/65/EU

Machinery Directive
Electromagnetic Compatibility Directive
RoHS Directive (as amended by (EU) 2015/863)

Harmonized Standards and Technical Specifications applied:

ISO 12100:2010
IEC 60204-1:2005/A1:2008
IEC 61000-6-2:2016◆

IEC 61000-6-4:2018◆

IEC 61000-3-2:2018◆

IEC 61000-3-3:2013

EN 50581:2012

◆--Reference Standard

Safety of machinery—General principle for design—Risk assessment and risk reduction
Safety of machinery—Electrical equipment of machines—Part 1
Electromagnetic Compatibility (EMC)—Part 6-2: Generic standards—Immunity for industrial environments
Electromagnetic Compatibility (EMC)—Part 6-4: Generic standards—Emission standard for industrial environments
Electromagnetic Compatibility (EMC)—Part 3-2: Limits-Limits for harmonic current emissions (equipment input current ≤ 16 A per phase)
Electromagnetic Compatibility (EMC)—Part 3-3: Limits-Limitation of voltage changes, voltage fluctuations and flicker in public low-voltage supply systems, for equipment with rated current ≤ 16 A per phase and not subject to conditional connection.
Technical documentation for the assessment of electrical and electronic products with respect to the restriction of hazardous substances.

Signed for and on behalf of:

Flexible Steel Lacing Company (Flexco)

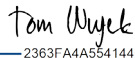
DocuSigned by:

2363FA4A5541446...

11/4/2021

Thomas S. Wujek, President & CEO

Date

Visit www.flexco.com for other Flexco locations and products, or to find an authorized distributor.

©2022 Flexible Steel Lacing Company. 04-29-24. For reorder: X3798

