

Flex-Lag[®] Cold Bond Pulley Lagging

Installation, Operation and Maintenance Manual

Light-Duty



Plain-Pattern



Diamond-Pattern Rubber



Diamond-Pattern Ceramic (15%)

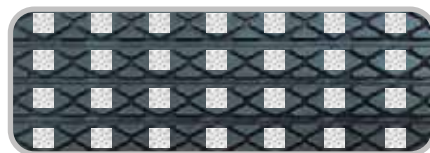

Medium Ceramic (39%)

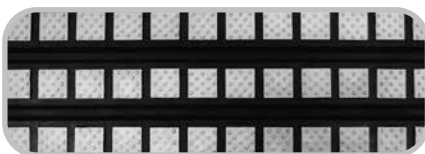

Full Ceramic (80%)



Flex-Lag® Cold Bond Pulley Lagging

Purchase Date: _____

Purchased From: _____

Installation Date: _____

This information will be helpful for any future inquiries or questions about replacement parts, specifications or troubleshooting.

Table of Contents

Section 1 – Important Information	4
1.1 General Introduction	4
1.2 User Benefits	4
1.3 Service Option	4
Section 2 – Safety Considerations and Precautions	5
2.1 Stationary Conveyors	5
2.2 Operating Conveyors	5
Section 3 – Pre-Installation Checks and Options.....	6
3.1 Checklist	6
Section 4 – Installation Instructions.....	7
Section 5 – Pre-Operation Checklist and Testing.....	11
5.1 Pre-Op Checklist	11
5.2 Test Run the Conveyor	11
Section 6 – Maintenance	12
6.1 New Installation Inspection	12
6.2 Routine Visual Inspection	12
6.3 Routine Physical Inspection.....	12
6.4 Maintenance Log	13
6.5 Lagging Maintenance Checklist	14
Section 7 – Troubleshooting	15
Section 8 – Specs and CAD Drawings.....	15
8.1 Specifications.....	15
8.2 Light Duty	16
8.3 Plain.....	17
8.4 Diamond.....	18
8.5 Diamond Ceramic.....	19
8.6 Medium Ceramic, Dimpled Tiles, Natural and FRAS.....	20
8.7 Medium Ceramic, Smooth Tiles, Natural and FRAS.....	21
8.8 Full Ceramic, Dimpled Tiles, Natural and FRAS	22
8.9 Full Ceramic, Smooth Tiles, Natural and FRAS.....	23
Section 9 – Lagging Adhesives/Toolbox	24
Section 10 – Other Flexco Conveyor Products	27

Section 1 – Important Information

1.1 General Introduction

We at Flexco are very pleased that you have selected Flex-Lag® Pulley Lagging for your conveyor system.

This manual will help you to understand the operation of this product and assist you in making it work up to its maximum efficiency over its lifetime of service.

It is essential for safe and efficient operation that the information and guidelines presented be properly understood and implemented. This manual will provide safety precautions, installation instructions, maintenance procedures and troubleshooting tips.

If, however, you have any questions or problems that are not covered, please contact your field representative or our Customer Service Department:

Customer Service: 612-8818-2000

Visit www.flexco.com for other Flexco locations and products.

Please read this manual thoroughly and pass it on to any others who will be directly responsible for installation, operation and maintenance of this pulley lagging. While we have tried to make the installation and service tasks as easy and simple as possible, **it does however require correct installation and regular inspections to maintain top working condition.**

1.2 User Benefits

Correct installation and regular maintenance will provide the following benefits for your operation:

- Eliminate belt slippage
- Reduced conveyor downtime
- Reduced man-hour labour
- Lower maintenance budget costs
- Increased service life for the lagging and pulley

1.3 Service Option

Flex-Lag® Pulley Lagging is designed to be easily installed and serviced by your on-site personnel. However, if you would prefer complete turn-key factory service, please contact your local Flexco Field Representative.

Section 2 – Safety Considerations and Precautions

Before installing and operating Flex-Lag® Pulley Lagging, it is important to review and understand the following safety information.

There are set-up, maintenance and operational activities involving both **stationary** and **operating** conveyors. Each case has a safety protocol.

2.1 Stationary Conveyors

The following activities are performed on stationary conveyors:

- Installation
- Cleaning

DANGER

It is imperative that Lockout/Tagout (LOTO) regulations, be followed before undertaking the preceding activities. Failure to use LOTO exposes workers to uncontrolled behavior of the products caused by movement of the conveyor belt. Severe injury or death can result.

Before working:

- Lockout/Tagout the conveyor power source
- Disengage any takeups
- Clear the conveyor belt or clamp securely in place

WARNING

Use Personal Protective Equipment (PPE):

- Safety eyewear (splash goggles optional)
- Approved air respirator (if ventilation is not available as recommended in enclosed Safety Data Sheets)
- Hardhat
- Long-sleeve shirt
- Safety footwear
- Apron (optional)
- Nitrile gloves

Close quarters and heavy components create a worksite that compromises a worker's eyes, feet and skull.

PPE must be worn to control the foreseeable hazards associated with conveyor lagging. Serious injuries can be avoided.

2.2 Operating Conveyors

There are two routine tasks that must be performed while the conveyor is running:

- Inspection of performance
- Dynamic troubleshooting

DANGER

Every belt pulley is an in-running nip hazard. Never touch or prod an operating pulley. Pulley hazards cause instantaneous amputation and entrapment.

WARNING

Pulleys can become projectile hazards. Stay as far from the pulley as practical and use safety eyewear and headgear. Missiles can inflict serious injury.

WARNING

Never adjust anything on an operating pulley. Unforeseeable belt projections and tears can cause violent movements. Flailing hardware can cause serious injury or death.

Section 3 – Pre-installation Checks and Options

3.1 Checklist

- Check that the lagging size is correct for the pulley width
- Check that the correct amount of lagging strips are available to lag the pulley (see Page 8).
- Check that the correct amount of primer, adhesive and activator are available to lag the pulley (see Page 8).
- Check the carton and make sure all the parts are included
- Review the “Tools Needed” list on the top of the installation instructions
- Check the conveyor site:
 - Will the lagging be installed in a chute
 - Is the install on an open head pulley

Conti® Primer, Adhesive and Activator ONLY for use with cold-bond rubber-to-rubber or rubber-to-metal adhesion.

Section 4 – Installation Instructions

If using non-Flexco adhesives, please follow that company's instructions for usage, mixing, application and safety procedures.

Flex-Lag Pulley Lagging can be used with Conti® Adhesives. Conti Adhesives consist of a Primer, Adhesive and Activator. Before using, the Primer should be thoroughly mixed. Before using, one Adhesive and one Activator should be thoroughly mixed and used within two hours. Reference the Adhesive Usage Charts on Page 6 for quantity of each material required based on Pulley Diameter and Face Width.

These materials are meant for use at room temperature. The ambient temperature and temperature of the lagging and pulley must be between 10°C – 40°C, and the relative humidity should not exceed 80% during the lagging procedure. These should be checked prior to starting and occasionally during the lagging process to ensure proper bonding.

Proper protective equipment should be used during the lagging process. Wear safety glasses with side shields. Wear chemical splash goggles if the possibility exists for eye contact with splashing liquid. Avoid skin contact by wearing chemically-resistant gloves (nitrile) and long sleeved shirt. An apron may be appropriate if splashing can occur. Respiratory protection may be required to avoid overexposure when handling this product. If general room ventilation is not available or sufficient use a an approved air purifying respirator. Please reference the Safety Data Sheets for Adhesive, Activator and Primer to see detailed requirements. Also, please follow any local or state guidelines for use of this product.

Physically lock out and tag the conveyor at the power source before you begin pulley lagging installation.

Tools Needed:

- Grinder (low RPM recommended)
- 24 Grit Flap Disc
- Bench Brush
- Coarse Dish Wheel
- Paint Brushes
- Heavy Duty Knife
- Chalk Line
- Dead Blow Rubber Hammer
- Lagging Stitchers/Rollers
- Oscillating Tool (for cutting rubber)

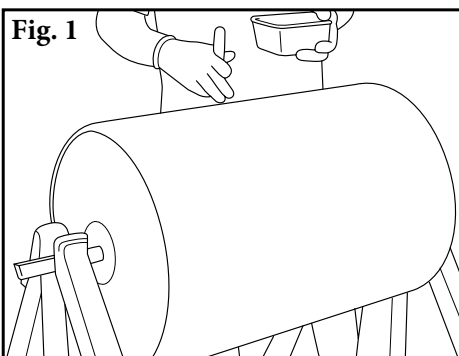

- 1. Prepare the pulley by removing the old lagging, paint and primer.** Sand blast the entire pulley or use a grinder with 24 grit flap disc or paper disc. Use bench brush and non-oil-based metal solvent to clean remaining particles from the pulley surface. Paint the pulley surface, including the edges, with Conti Primer. Allow to dry completely – a minimum of 30 minutes.

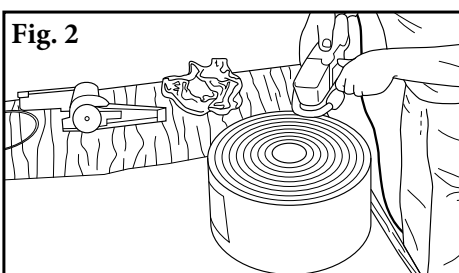

Section 4 – Installation Instructions (cont.)

3. Use the Strip Selection Chart at right to calculate the number of strips required for your pulley diameter. Using a heavy duty knife, cut lagging strips 100mm (4") longer than the pulley face width. Medium and Full Ceramic lagging come in pre-specified strip lengths. **Note: Do not allow ceramic tiles to sit at, or over, the edge of the pulley face.**

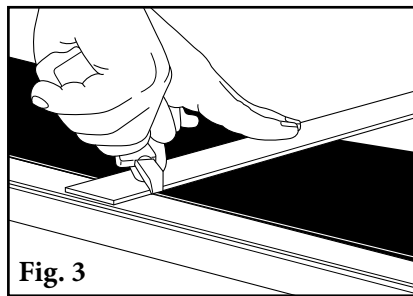

Fig. 3

Strip Selection

PULLEY DIAMETER		STRIPS REQUIRED	PULLEY DIAMETER		STRIPS REQUIRED
mm	in.		mm	in.	
320-381	12.6-15.0	6	1083-1145	42.6-45.0	18
382-445	15.1-17.5	7	1146-1210	45.1-47.5	19
446-510	17.6-20.0	8	1211-1273	47.6-50.1	20
511-573	20.1-22.5	9	1274-1336	50.2-52.6	21
574-636	22.6-25.0	10	1337-1400	52.7-55.1	22
637-700	25.1-27.5	11	1403-1463	55.2-57.6	23
701-764	27.6-30.0	12	1466-1527	57.7-60.1	24
765-827	30.1-32.5	13	1529-1590	60.2-62.6	25
828-891	32.6-35.0	14	1593-1654	62.7-65.1	26
892-955	35.1-37.5	15	1656-1717	65.2-67.6	27
956-1018	37.6-40.0	16	1720-1781	67.7-70.1	28
1019-1082	40.1-42.5	17	1783-1844	70.2-72.6	29

Adhesive, Activator and Primer Usage Charts

CONTI® ADHESIVE 0.8L (27.0 oz.) / ACTIVATOR 40g (1.4 oz.) (1:1 mix ratio)

mm.		Face Width																					
		254	356	457	559	660	762	864	965	1067	1168	1270	1372	1473	1575	1676	1778	1880	1981	2083	2184	2286	
Pulley Diameter	in.	10	14	18	22	26	30	34	38	42	46	50	54	58	62	66	70	74	78	82	86	90	
	203	8	1	1	1	1	1	1	1	1	2	2	2	2	2	2	2	2	2	2	3	3	3
	305	12	1	1	1	1	1	2	2	2	2	2	3	3	3	3	3	3	3	3	4	4	4
	406	16	1	1	1	2	2	2	2	2	3	3	3	3	3	4	4	4	4	4	5	5	5
	508	20	1	1	2	2	2	2	3	3	3	3	4	4	4	4	5	5	5	5	6	6	6
	610	24	1	2	2	2	2	3	3	3	4	4	4	5	5	5	5	6	6	6	7	7	7
	711	28	1	2	2	2	3	3	3	4	4	5	5	5	6	6	6	7	7	7	8	8	8
	813	32	2	2	2	3	3	4	4	4	5	5	6	6	6	7	7	8	8	8	9	9	10
	914	36	2	2	3	3	3	4	4	5	5	6	6	7	7	8	8	8	9	9	10	10	11
	1016	40	2	2	3	3	4	4	5	5	6	6	7	7	8	8	9	9	10	10	11	11	12
	1118	44	2	2	3	4	4	5	5	6	6	7	7	8	9	9	10	10	11	11	12	12	13
	1219	48	2	3	3	4	4	5	6	6	7	7	8	9	9	10	10	11	12	12	13	13	14
	1321	52	2	3	3	4	5	5	6	7	7	8	9	9	10	11	11	12	13	13	14	15	15
	1422	56	2	3	4	4	5	6	6	7	8	9	9	10	11	11	12	13	14	14	15	16	16
	1524	60	2	3	4	5	5	6	7	8	8	9	10	11	11	12	13	14	14	15	16	17	17

CONTI® PRIMER .75L (25.4 oz.)

mm.		Face Width																					
		254	356	457	559	660	762	864	965	1067	1168	1270	1372	1473	1575	1676	1778	1880	1981	2083	2184	2286	
Pulley Diameter	in.	10	14	18	22	26	30	34	38	42	46	50	54	58	62	66	70	74	78	82	86	90	
	203	8	1	1	1	1	1	1	1	1	1	1	1	1	1	1	1	1	1	1	1	1	1
	305	12	1	1	1	1	1	1	1	1	1	1	1	1	1	1	1	1	1	1	1	1	1
	406	16	1	1	1	1	1	1	1	1	1	1	1	1	1	1	1	1	1	1	1	1	1
	508	20	1	1	1	1	1	1	1	1	1	1	1	1	1	1	1	1	1	1	1	1	1
	610	24	1	1	1	1	1	1	1	1	1	1	1	1	1	1	1	1	1	1	1	1	1
	711	28	1	1	1	1	1	1	1	1	1	1	1	1	1	1	1	1	1	1	1	1	1
	813	32	1	1	1	1	1	1	1	1	1	1	1	1	1	1	1	1	1	1	1	1	1
	914	36	1	1	1	1	1	1	1	1	1	1	1	1	1	1	1	1	1	1	1	1	2
	1016	40	1	1	1	1	1	1	1	1	1	1	1	1	1	1	1	1	1	1	2	2	2
	1118	44	1	1	1	1	1	1	1	1	1	1	1	1	1	1	1	2	2	2	2	2	2
	1219	48	1	1	1	1	1	1	1	1	1	1	1	1	1	1	2	2	2	2	2	2	2
	1321	52	1	1	1	1	1	1	1	1	1	1	1	1	1	2	2	2	2	2	2	2	2
	1422	56	1	1	1	1	1	1	1	1	1	1	1	1	2	2	2	2	2	2	2	2	2
	1524	60	1	1	1	1	1	1	1	1	1	1	1	2	2	2	2	2	2	2	2	2	2

Section 4 – Installation Instructions (cont.)

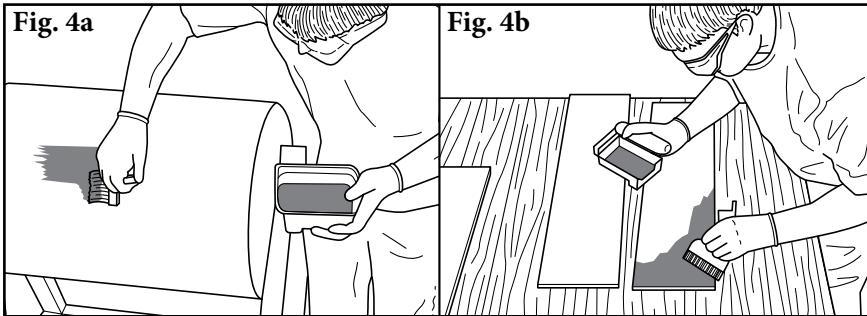

4. **Apply first coat of adhesive.** Thoroughly mix one can of adhesive and one activator at a time, immediately applying it to the pulley and strips of lagging using a circular scrubbing motion. Be sure to apply adhesive to the edges of the lagging as well. This process should use half of the adhesive/activator required in the chart on Page 6. **Note: Allow to dry for a minimum of 25 minutes at 23°–25° C (73°–77° F). Temperature and humidity will affect dry time.**

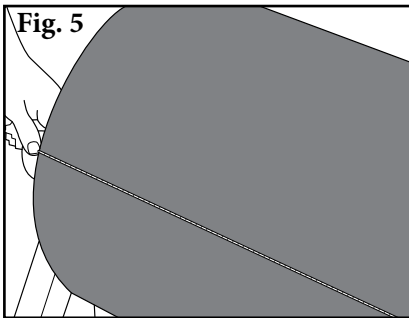

5. **After the first coat of adhesive has dried completely, mark a line across the pulley face using a chalk line or scribe, ensuring the line is parallel to the shaft's centreline and square to the edge of the pulley.**

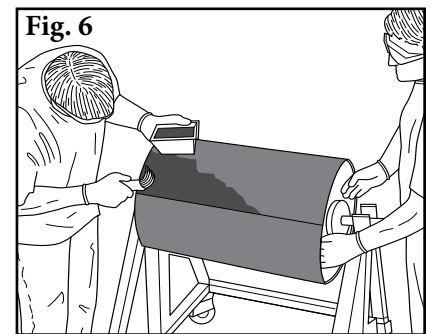

6. **Apply second coat of adhesive to the pulley.** Thoroughly mix one can of adhesive and activator at a time. From the perpendicular line, apply the second coat of adhesive to an area slightly greater than one strip of lagging.

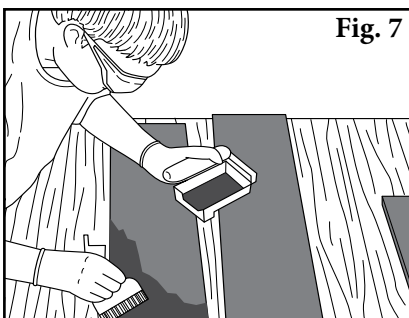

7. **Apply a second coat of adhesive to one strip of lagging.** Be sure to apply adhesive to the edges of the lagging as well.

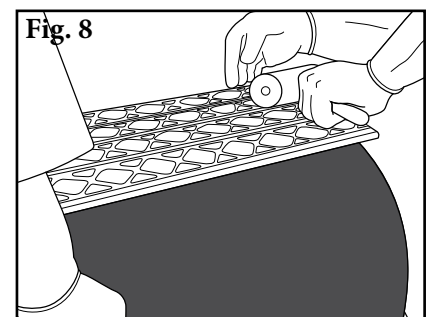

8. **After the second coat has reached the appropriate tackiness** (approximately 2-5 minutes, touch with back of hand – feels tacky and leaves no adhesive on hand) install one strip of lagging, using the perpendicular line to assure the strip is square to the pulley. Working out from the centre of the strip, use a dead blow rubber hammer for tamping to remove the air gaps, ensuring all surface area receives one hammer blow. Repeat this process with Lagging Stitchers/Rollers to remove air gaps from drainage grooves. Be sure to check edges to verify seal.

Section 4 – Installation Instructions (cont.)

9. Repeat Steps 6 and 7, then place the second strip of lagging against the first, taking care to ensure there are no gaps between the lagging. This may require additional stitching between strips to remove any gaps. Repeat the tamping and stitching process in Step 8 to remove air gaps from the applied strip. Shift lagging side-to-side to align diamond/ceramic patterns.

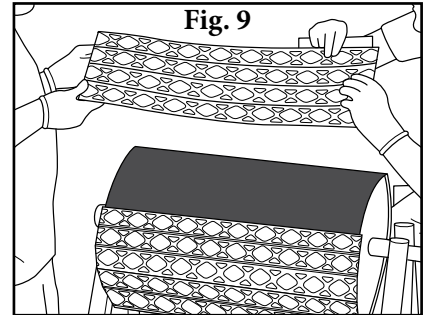

10. Trim the excess lagging from applied strips at the edge of the pulley using a heavy duty knife or oscillating tool. Trim lagging at an angle up and away from the pulley edge.

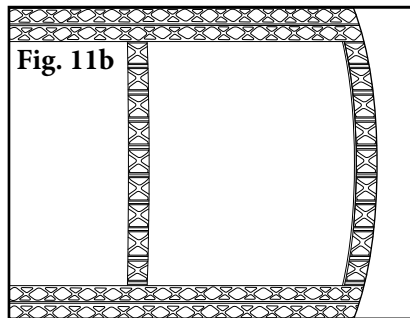
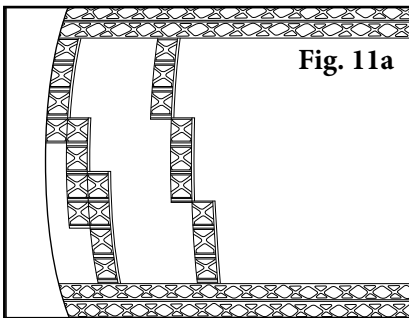
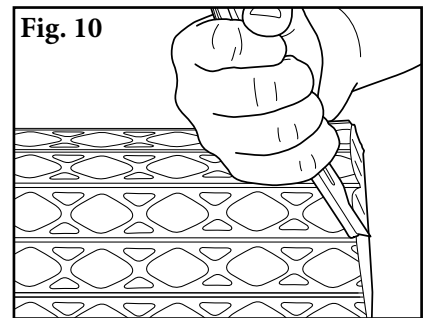

11. To apply the last 3-4 strips, position cut-off pieces of lagging from Step 10 in the unlagged portion of the pulley. Manipulate the pieces to determine trim requirements for the last few strips. Trim the pieces in the gutters to find the proper fit. Use the pieces as templates to trim the last few strips of lagging. **Note: Final strips should not consist of less than three rows.**

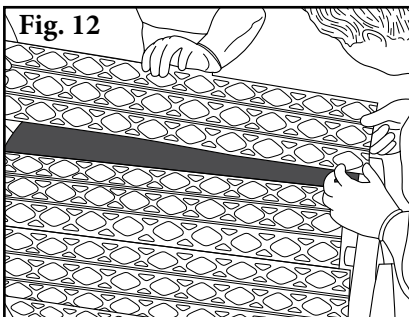

12. Follow Steps 6 through 10 to install the last 3-4 strips. The final piece of lagging (largest of final pieces) should drop into position. Check the fit of the last piece prior to applying the second coat of adhesive.

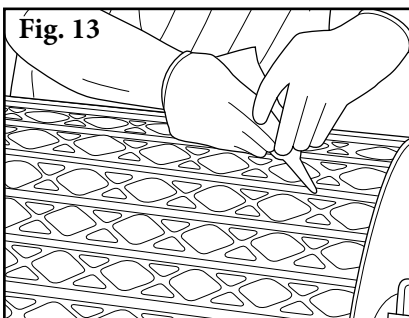

13. Fill any gaps between the lagging strips with rubber sealer. Also use the buffing wheel on trimmed edge of lagging and apply final coat of adhesive to seal the edge and joint area between lagging strips.

Note: Allow minimum of 24 hours of curing time before putting newly lagged pulley into use.

Section 5 – Pre-Operation Checklist and Testing

5.1 Pre-Op Checklist

- Be sure that all installation materials and tools have been removed from the belt and the conveyor area.

5.2 Test Run the Conveyor

- Run the conveyor for at least 15 minutes and inspect the lagging performance.

NOTE: Observing the pulley lagging when it is running and performing properly will help to detect problems.

Section 6 – Maintenance

All safety procedures for inspection of equipment (stationary or operating) must be observed. Flex-Lag® Pulley Lagging is in direct contact with the moving belt. Only visual observations can be made while the belt is running. Service tasks can be done only with the conveyor stopped and by observing the correct lockout/tagout procedures.

6.1 New Installation Inspection

After the new lagging has run for a few days a visual inspection should be made to ensure the lagging is performing properly.

6.2 Routine Visual Inspection (every 6-8 weeks)

A visual inspection of the lagging and belt can determine:

- If there is damage to the lagging.
- If fugitive material is built up on the lagging.
- If there is damage to the belt.

If any of the above conditions exist, a determination should be made on when the conveyor can be stopped for additional maintenance.

6.3 Routine Physical Inspection (every 3-4 months)

When the conveyor is not in operation and properly locked and tagged out, conduct a physical inspection of the lagging to perform the following tasks:

- Clean material buildup off of the lagging.
- Closely inspect the lagging for wear and any damage.
- Ensure full lagging to belt contact.
- Inspect the belt for damage.
- Replace any worn or damaged components.
- When maintenance tasks are completed, test run the conveyor to ensure the lagging is performing properly.

Section 6 – Maintenance (cont.)

6.4 Maintenance Log

Conveyor Name/No. _____

Date: _____ Work done by: _____ Service Quote #: _____

Activity: _____

Date: _____ Work done by: _____ Service Quote #: _____

Activity: _____

Date: _____ Work done by: _____ Service Quote #: _____

Activity: _____

Date: _____ Work done by: _____ Service Quote #: _____

Activity: _____

Date: _____ Work done by: _____ Service Quote #: _____

Activity: _____

Date: _____ Work done by: _____ Service Quote #: _____

Activity: _____

Date: _____ Work done by: _____ Service Quote #: _____

Activity: _____

Date: _____ Work done by: _____ Service Quote #: _____

Activity: _____

Section 6 – Maintenance (cont.)

6.6 Lagging Maintenance Checklist

Site: _____ Inspected by: _____ Date: _____

Lagging: _____

Beltline Information:

Beltline Number: _____ Belt Condition: _____

Belt Width: 450mm (18") 600mm (24") 750mm (30") 900mm (36") 1050mm (42") 1200mm (48") 1350mm (54") 1500mm (60") 1800mm (72")

Head Pulley Diameter (Belt & Lagging): _____ Belt Speed: _____ fpm or m/s Belt Thickness: _____

Belt Splice: _____ Condition of Splice: _____ Number of Splices: _____ Skived Unskived

Material conveyed: _____

Days per week run: _____ Hours per day run: _____

Lagging Life:

Date installed: _____ Date inspected: _____ Estimated life: _____

Lagging Thickness: _____

Lagging: Side Lag Ceramic Rubber Other None

Condition of lagging: Good Bad Other _____

Cleaner's Overall Performance: (Rate the following 1 - 5, 1= very poor - 5 = very good)

Appearance: Comments: _____

Location: Comments: _____

Maintenance: Comments: _____

Performance: Comments: _____

Other comments: _____

Section 7 – Troubleshooting

Problem	Possible Cause	Possible Solutions
Uneven wear in rubber lagging	Belt Tension	Change to ceramic lagging
	Short Transition	Increase distance to full trough idler
	Wrong Lagging for Application	Increase thickness or change to ceramic lagging
Delaminating	Glue too wet or dry when applied	Refer to instructions on p. 5-8 for proper installation instructions
	Pulley surface not prepped correctly	Refer to instructions on p. 5-8 for proper installation instructions

For additional troubleshooting questions, please contact Customer Service or your territory manager.

Section 8 – Specifications and CAD Drawings

8.1 Specifications

Criteria	Flex-Lag® Rubber			Flex-Lag® Ceramic			Flex-Lag® Weld-On™	
	Light Duty	Plain	Diamond	15% Coverage	39% Coverage	80% Coverage	Rubber Diamond	Ceramic 74% Coverage
Total Thickness*	7.5 mm	10 – 25 mm	10 – 25 mm	12 mm	15 mm	12 mm	14 mm	15 mm
Belt Width*	Any Width	Any Width	Any Width	Any Width	450 – 2100 mm	450 – 2100 mm	450 – 1800 mm	450 – 1800 mm
Minimum Pulley Diameter	300mm	300mm	300mm	300mm	300mm	300mm	400mm	400mm
Dry Performance	Very Good	Excellent	Excellent	Excellent	Excellent	Excellent	Excellent	Excellent
Wet Performance	Average	Average	Good	Very Good	Excellent	Excellent	Good	Excellent
Wear Life	Good	Very Good	Very Good	Excellent	Excellent	Excellent	Very Good	Excellent
Ease of Installation	Good	Good	Good	Good	Good	Good	Excellent	Excellent
Drainage Grooves	No	Yes	Yes	Yes	Yes	Yes	Yes	Yes
FRAS (Fire Resistant Anti Static)	No	Yes	Yes	Yes	Yes	Yes	Yes	Yes
Compound	SBR	SBR	SBR	SBR	SBR	SBR	SBR	SBR
Hardness (Shore A)	68 +/-3	68 +/-3	68 +/-3	68 +/-3	68 +/-3	68 +/-3	68 +/-3	68 +/-3
Operating Temperature	-15° – 85° C	-15° – 85° C	-15° – 85° C	-15° – 85° C	-15° – 85° C	-15° – 85° C	-15° – 85° C	-15° – 85° C

*Additional thicknesses and widths available as special orders. For weld-on lagging, this includes the steel backing plate.

NOTE: Available with an uncured layer suitable for autoclaving

Section 8 – Specifications and CAD Drawings (cont.)

8.2 Lagging - Light Duty Rubber

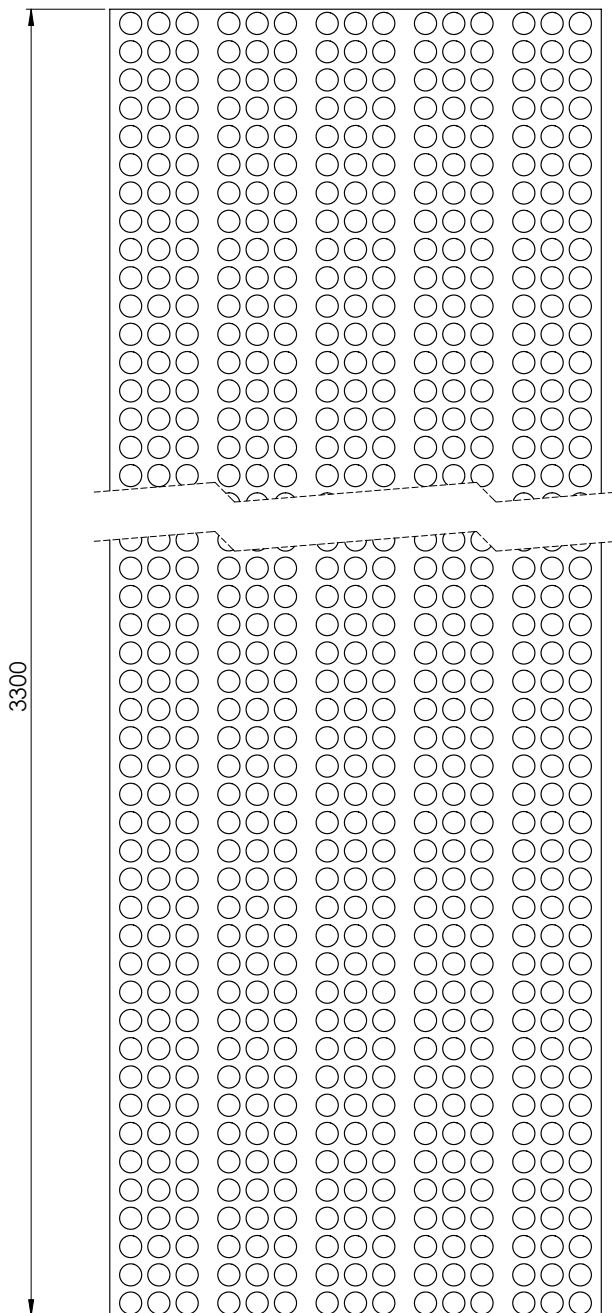
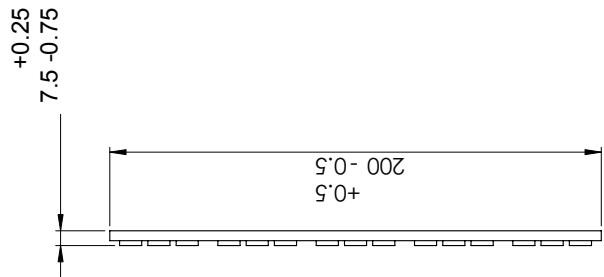

DESCRIPTION	ORDERING NUMBER	ITEM CODE
WHITE NITRILE RUBBER	7.5WLD3.3/11	71076
BLACK NATURAL RUBBER	7.5NLD3.3/11	71077

Section 8 – Specifications and CAD Drawings (cont.)

8.3 Lagging - Plain Rubber

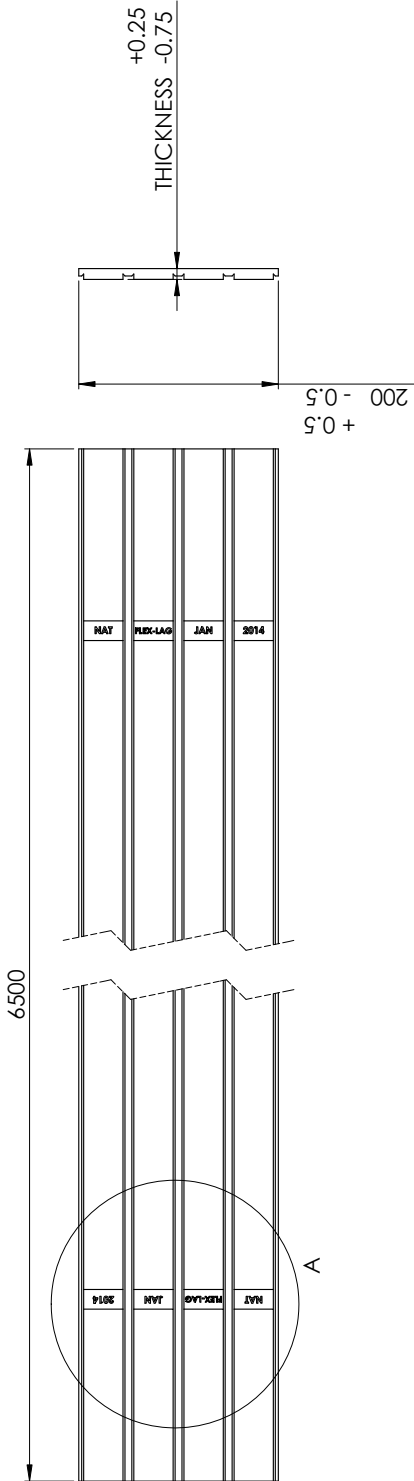

DETAIL A
SCALE 1 : 2

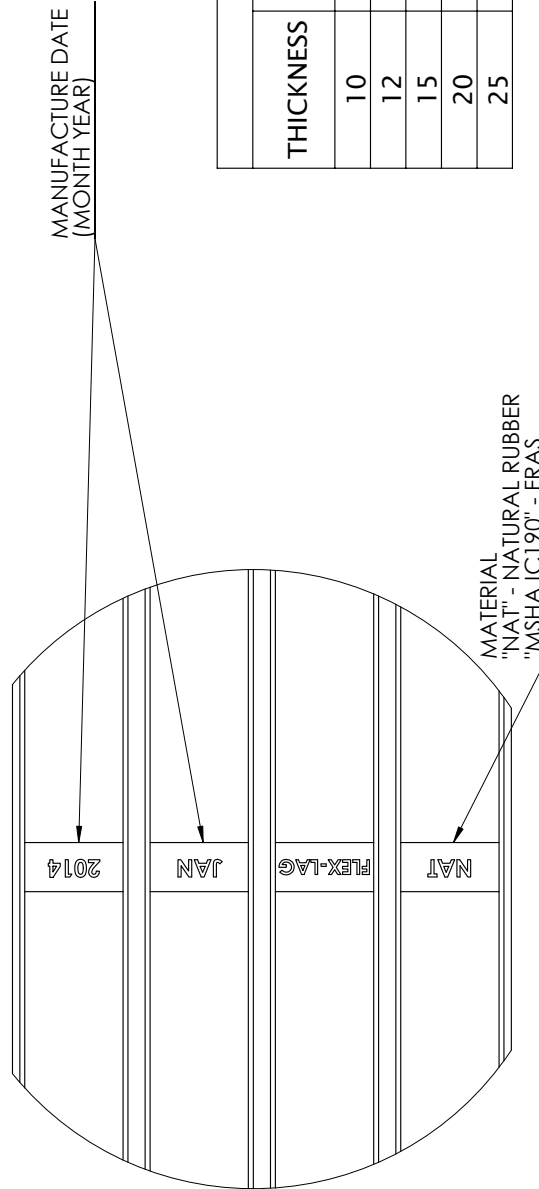

NATURAL RUBBER			
THICKNESS	ITEM CODE	ORDERING NUMBER	WEIGHT
10	71010	10NP6.5/21	16
12	71012	12NP6.5/21	18
15	71017	15NP6.5/21	23
20	71021	20NP6.5/21	26
25	71163	25NP6.5/21	29

FRAS RUBBER			
THICKNESS	ITEM CODE	ORDERING NUMBER	WEIGHT
10	71020	10FRP6.5/21	17
12	71022	12FRP6.5/21	20
15	71015	15FRP6.5/21	24
20	72129	20FRP6.5/21	27

Section 8 – Specifications and CAD Drawings (cont.)

8.4 Lagging - Diamond-Pattern Rubber

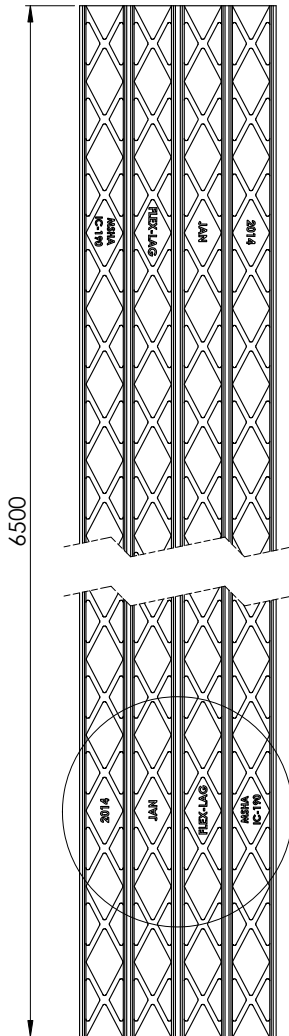
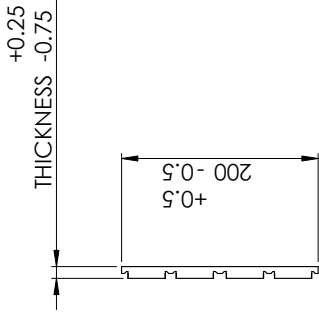

DETAIL A
SCALE 1:2

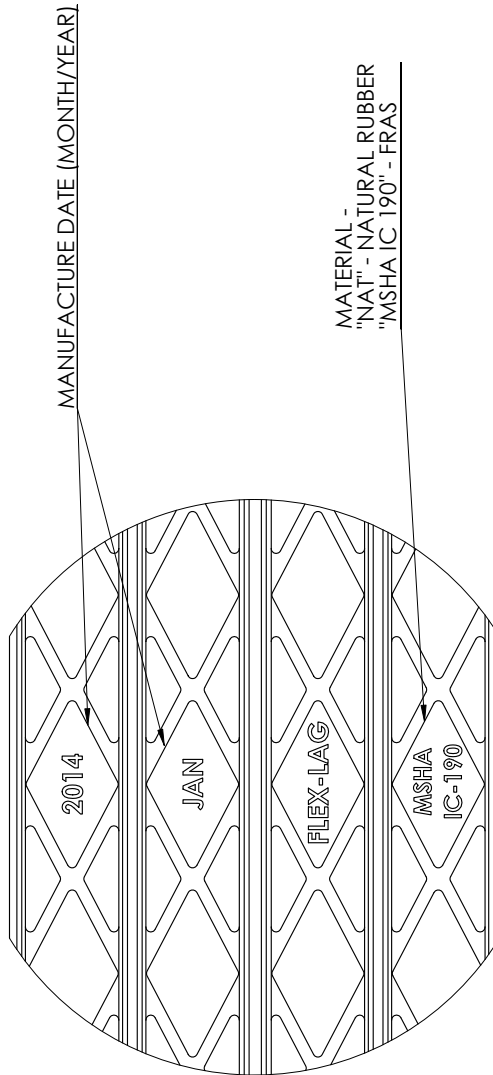

MATERIAL -
"NAT" - NATURAL RUBBER
"MSHA IC 190" - FRAS

NATURAL RUBBER			
THICKNESS	ITEM CODE	ORDERING NUMBER	WEIGHT
10	71002	10ND6.5/21	13
12	71004	12ND6.5/21	17
15	71006	15ND6.5/21	22
20	71008	20ND6.5/21	24
25	71152	25ND6.5/21	27

FRAS RUBBER			
THICKNESS	ITEM CODE	ORDERING NUMBER	WEIGHT
10	71014	10FRD6.5/21	14.5
12	71016	12FRD6.5/21	18
15	71018	15FRD6.5/21	24
20	71019	20FRD6.5/21	27

Section 8 – Specifications and CAD Drawings (cont.)

8.5 Lagging - Diamond Ceramic

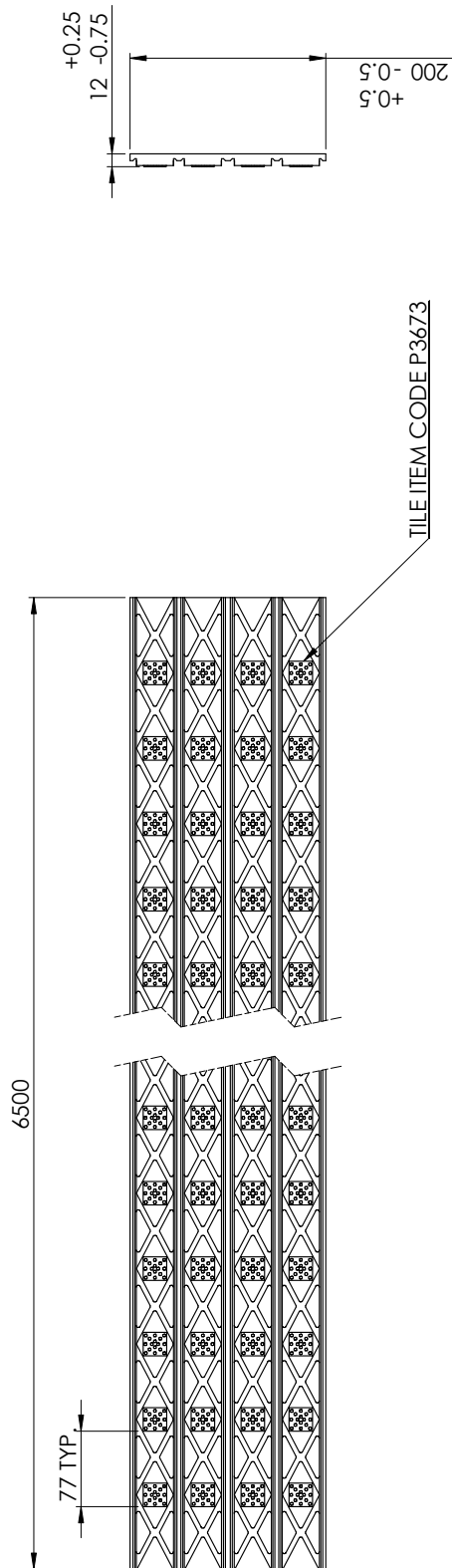

THICKNESS	MATERIAL	ITEM CODE	ORDERING NUMBER	WEIGHT	QTY. TILES
12	NATURAL RUBBER	71155	12NDC6.5/21	25	328
12	FRAS	71159	12FRDC6.5/21	27	328

Section 8 – Specifications and CAD Drawings (cont.)

8.6 Lagging - Medium Ceramic, Dimpled Tiles, Natural and FRAS

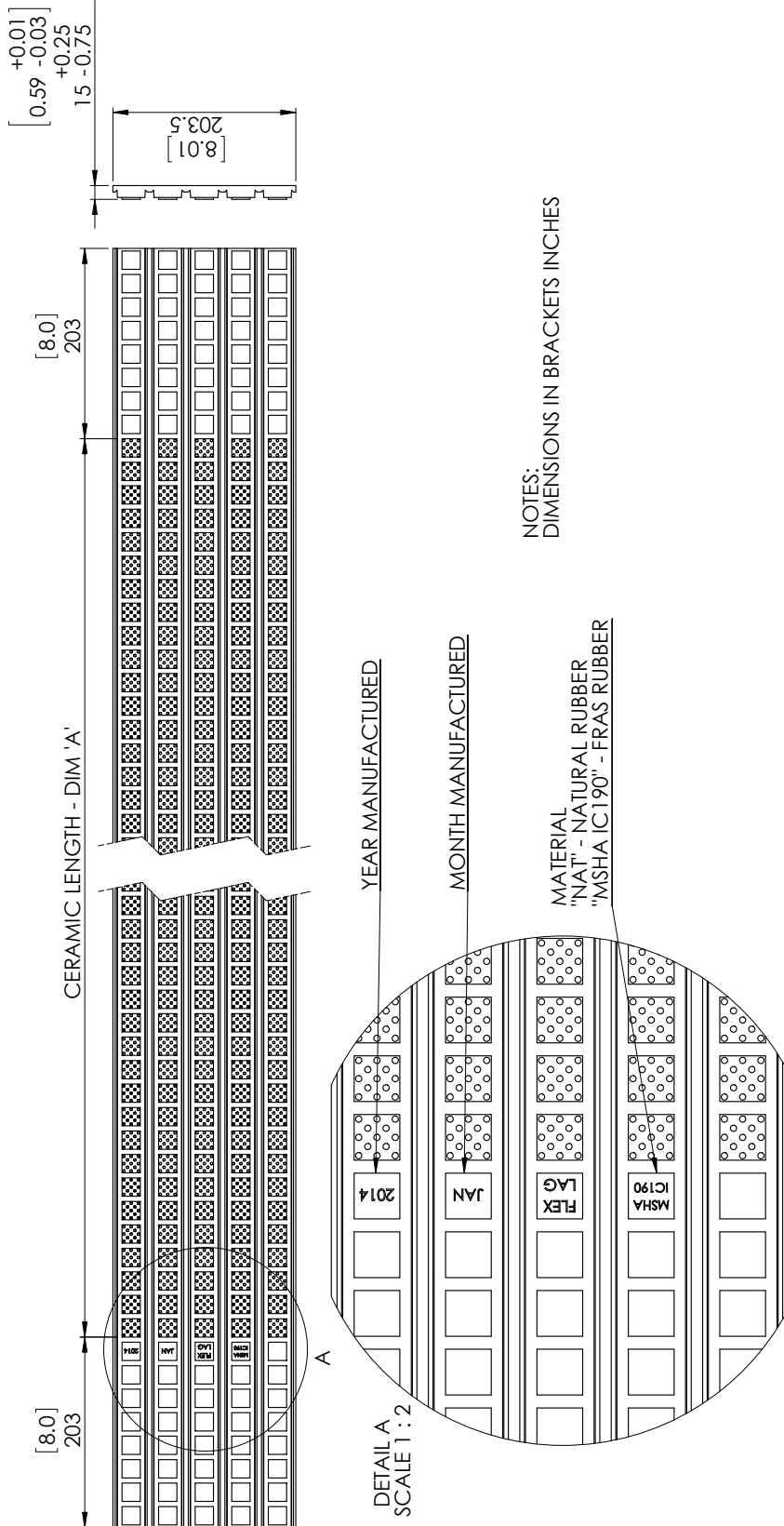

NOTES:
DIMENSIONS IN BRACKETS INCHES

39% FRAS LAGGING					
BELT WIDTH	ITEM CODE	DIM 'A'	CERAMIC TILES PER PIECE	TOTAL LENGTH	ORDERING NUMBER
[18"] 450mm	61308	18.67"	474mm	872.44	CLMFR450/18-15
[24"] 600mm	61309	24.63"	626mm	1026.40	CLMFR600/24-15
[30"] 750mm	61310	30.67"	779mm	1180.36	CLMFR750/30-15
[36"] 900mm	61311	36.66"	931mm	1334.32	CLMFR900/36-15
[42"] 1050mm	61312	42.61"	1082mm	1488.28	CLMFR1050/42-15
[48"] 1200mm	61313	48.64"	1235mm	1642.24	CLMFR1200/48-15
[54"] 1350mm	61314	54.64"	1388mm	1796.20	CLMFR1350/54-15
[60"] 1500mm	61315	60.66"	1541mm	1950.16	CLMFR1500/60-15
[72"] 1800mm	61316	72.52"	1842mm	2258.08	CLMFR1800/72-15
[84"] 2100mm	61317	84.86"	2155mm	2566.00	CLMFR2100/84-15
[21'] 6500mm	61319	252"	6500mm	6500mm	CLMFR6.5/21-15

39% LAGGING					
BELT WIDTH	ITEM CODE	DIM 'A'	CERAMIC TILES PER PIECE	TOTAL LENGTH	ORDERING NUMBER
[18"] 450mm	61294	18.67"	474mm	872.44	CLMN450/18-15
[24"] 600mm	61295	24.63"	626mm	1026.40	CLMN600/24-15
[30"] 750mm	61296	30.67"	779mm	1180.36	CLMN750/30-15
[36"] 900mm	61297	36.66"	931mm	1334.32	CLMN900/36-15
[42"] 1050mm	61298	42.61"	1082mm	1488.28	CLMN1050/42-15
[48"] 1200mm	61299	48.64"	1235mm	1642.24	CLMN1200/48-15
[54"] 1350mm	61300	54.64"	1388mm	1796.20	CLMN1350/54-15
[60"] 1500mm	61301	60.66"	1541mm	1950.16	CLMN1500/60-15
[72"] 1800mm	61302	72.52"	1842mm	2258.08	CLMN1800/72-15
[84"] 2100mm	61303	84.86"	2155mm	2566.00	CLMN2100/84-15
[21'] 6500mm	62216	252"	6500mm	6500mm	CLMN6.5/21-15

Section 8 – Specifications and CAD Drawings (cont.)

8.7 Lagging - Medium Ceramic, Smooth Tiles, Natural and FRAS

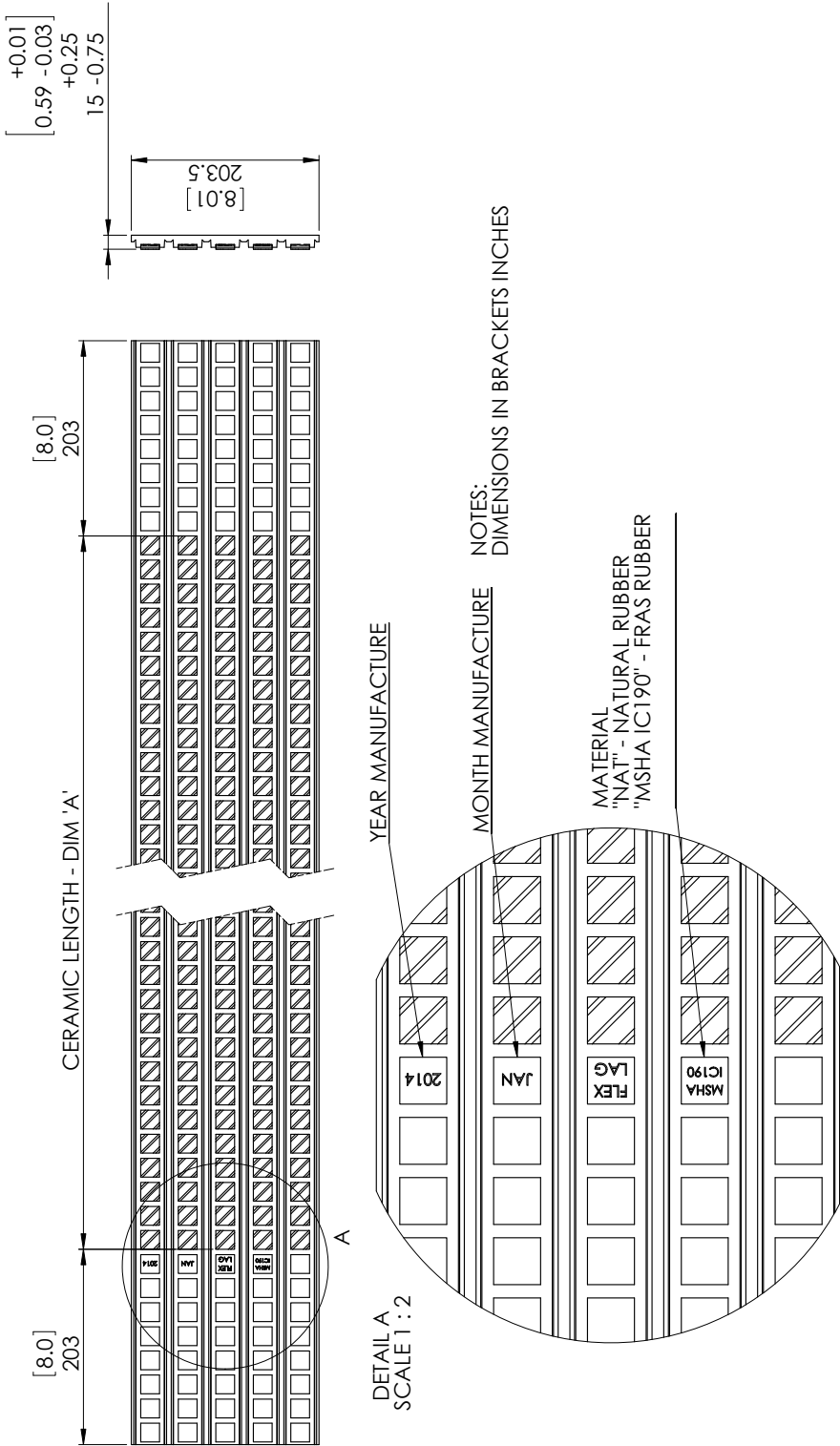

NOTES:
DIMENSIONS IN BRACKETS INCHES

39% LAGGING				39% FRAS LAGGING			
BELT WIDTH	ITEM CODE	DIM 'A'	CERAMIC TILES PER PIECE	TOTAL LENGTH	ORDERING NUMBER	CERAMIC TILES PER PIECE	TOTAL LENGTH
[18"] 450mm	62052	18.67"	95	872.44	CLMN450/18-155	95	872.44
[24"] 600mm	62053	24.63"	125	1026.40	CLMN600/24-155	125	1026.40
[30"] 750mm	62054	30.67"	155	1180.36	CLMN750/30-155	155	1180.36
[36"] 900mm	62055	36.66"	185	1334.32	CLMN900/36-155	185	1334.32
[42"] 1050mm	62056	42.61"	215	1488.28	CLMN1050/42-155	215	1488.28
[48"] 1200mm	62057	48.64"	245	1642.24	CLMN1200/48-155	245	1642.24
[54"] 1350mm	62058	54.64"	275	1796.20	CLMN1350/54-155	275	1796.20
[60"] 1500mm	62059	60.66"	305	1950.16	CLMN1500/60-155	305	1950.16
[72"] 1800mm	62060	72.52"	365	2258.08	CLMN1800/72-155	365	2258.08
[84"] 2100mm	62061	84.86"	425	2566.00	CLMN2100/84-155	425	2566.00

Section 8 – Specifications and CAD Drawings (cont.)

8.8 Lagging - Full Ceramic, Dimpled Tiles, Natural and FRAS

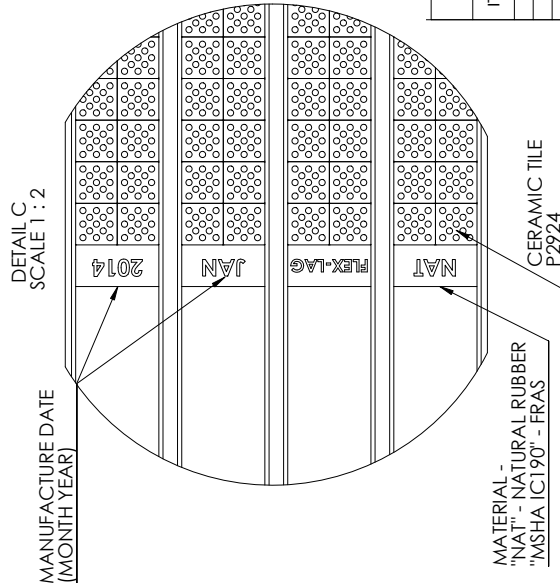
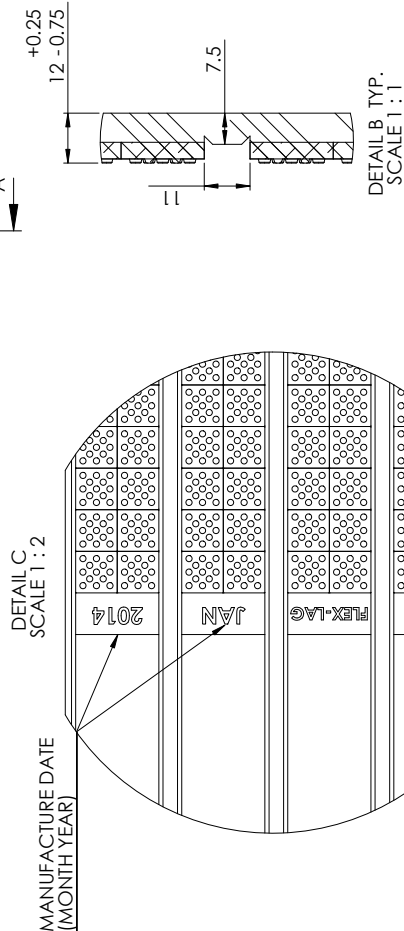
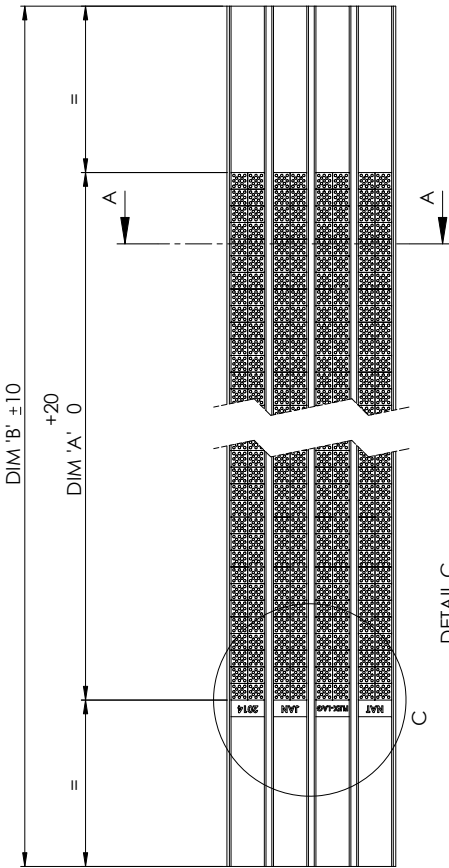
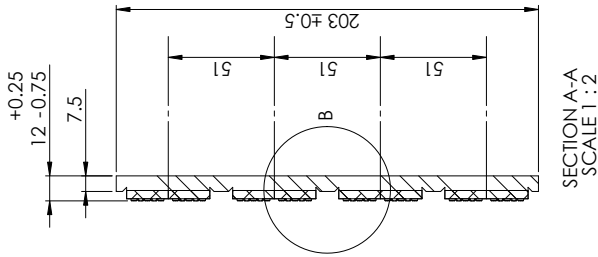

REFERENCE TABLE FOR FULL CERAMIC FRAS COMPOUND LAGGING

ITEM CODE	ORDERING NUMBER	CERAMIC SPAN DIM 'A'	OVERALL LENGTH DIM 'B'
71118	CLFR460/18.4-12	460	860
71119	CLFR600/24-12	600	1000
71120	CLFR760/30.4-12	760	1160
71121	CLFR800/32-12	800	1200
71122	CLFR900/36-12	900	1300
71123	CLFR1060/42.4-12	1060	1500
71005	CLFR1200/48-12	1200	1600
A1636	CLFR1360/54.4-12	1360	1800
71007	CLFR1400/56-12	1400	1900
71009	CLFR1520/60.8-12	1520	2000
71124	CLFR1600/64-12	1600	2100
71078	CLFR1700/68-12	1700	2200
71079	CLFR1800/72-12	1800	2300
71080	CLFR1900/76-12	1900	2400
71081	CLFR2000/80-12	2000	2500
71082	CLFR2100/84-12	2100	2600
71083	CLFR2200/88-12	2200	2700
71084	CLFR2300/92-12	2300	2800
71085	CLFR2400/96-12	2400	2900
71086	CLFR2500/100-12	2500	3000
71087	CLFR2600/104-12	2600	3000
71088	CLFR2800/112-12	2800	3300
71089	CLFR3000/120-12	3000	3300

REFERENCE TABLE FOR FULL CERAMIC NATURAL RUBBER LAGGING

ITEM CODE	ORDERING NUMBER	CERAMIC SPAN DIM 'A'	OVERALL LENGTH DIM 'B'
71111	CLN460/18.4-12	460	860
71112	CLN600/24-12	600	1000
71113	CLN760/30.4-12	760	1160
71114	CLN800/32-12	800	1200
71115	CLN900/36-12	900	1300
71116	CLN1060/42.4-12	1060	1500
71039	CLN1200/48-12	1200	1600
71126	CLN1360/54.4-12	1360	1800
71040	CLN1400/56-12	1400	1900
71127	CLN1520/60.8-12	1520	2000
71117	CLN1600/64-12	1600	2100
71041	CLN1700/68-12	1700	2200
71042	CLN1800/72-12	1800	2300
71043	CLN1900/76-12	1900	2400
71037	CLN2000/80-12	2000	2500
71044	CLN2100/84-12	2100	2600
71045	CLN2200/88-12	2200	2700
71046	CLN2300/92-12	2300	2800
71047	CLN2400/96-12	2400	2900
71048	CLN2500/100-12	2500	3000
71049	CLN2600/104-12	2600	3000
71050	CLN2800/112-12	2800	3300
71000	CLN3000/120-12	3000	3300

Section 8 – Specifications and CAD Drawings (cont.)

8.9 Lagging - Full Ceramic, Smooth Tiles, Natural and FRAS

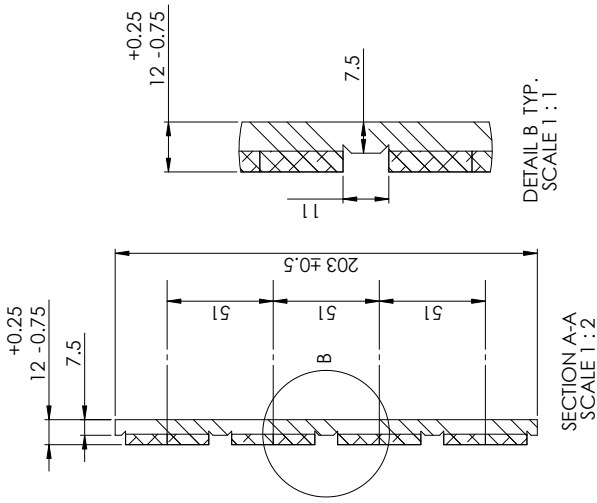

DETAIL B TYP.
SCALE 1:1

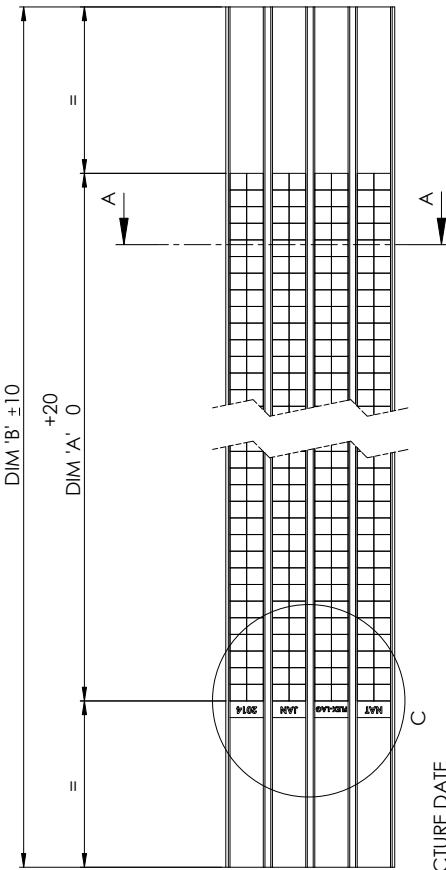

MANUFACTURE DATE
(MONTH YEAR)

CERAMIC TILE
P2924

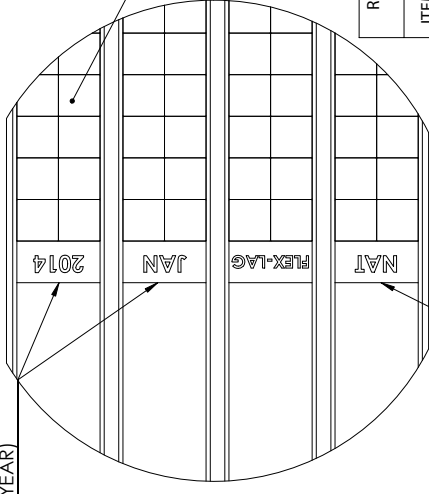

MATERIAL - NATURAL RUBBER
"MSHA IC190" - FRAS

REFERENCE TABLE FOR FULL CERAMIC FRAS COMPOUND LAGGING

ITEM CODE	ORDERING NUMBER	CERAMIC SPAN DIM 'A'	OVERALL LENGTH DIM 'B'
79406	CLFR460/18.4-125	460	860
79407	CLFR600/24-125	600	1000
79408	CLFR760/30.4-125	760	1160
79409	CLFR800/32-125	800	1200
79410	CLFR900/36-125	900	1300
79411	CLFR1060/42.4-125	1060	1500
79412	CLFR1200/48-125	1200	1600
79413	CLFR1360/54.4-125	1360	1800
79414	CLFR1400/56-125	1400	1900
79415	CLFR1520/60.8-125	1520	2000
79416	CLFR1600/64-125	1600	2100
79417	CLFR1700/68-125	1700	2200
79418	CLFR1800/72-125	1800	2300
79419	CLFR1900/76-125	1900	2400
79420	CLFR2000/80-125	2000	2500
79421	CLFR2100/84-125	2100	2600
79422	CLFR2200/88-125	2200	2700
79423	CLFR2300/92-125	2300	2800
79424	CLFR2400/96-125	2400	2900
79425	CLFR2500/100-125	2500	3000
79426	CLFR2600/104-125	2600	3000
79427	CLFR2800/112-125	2800	3300
79428	CLFR3000/120-125	3000	3300

REFERENCE TABLE FOR FULL CERAMIC NATURAL RUBBER LAGGING

ITEM CODE	ORDERING NUMBER	CERAMIC SPAN DIM 'A'	OVERALL LENGTH DIM 'B'
79383	CLN460/18.4-125	460	860
79384	CLN600/24-125	600	1000
79385	CLN760/30.4-125	760	1160
79386	CLN800/32-125	800	1200
79387	CLN900/36-125	900	1300
79388	CLN1060/42.4-125	1060	1500
79389	CLN1200/48-125	1200	1600
79390	CLN1360/54.4-125	1360	1800
79391	CLN1400/56-125	1400	1900
79392	CLN1520/60.8-125	1520	2000
79393	CLN1600/64-125	1600	2100
79394	CLN1700/68-125	1700	2200
79395	CLN1800/72-125	1800	2300
79396	CLN1900/76-125	1900	2400
79397	CLN2000/80-125	2000	2500
79398	CLN2100/84-125	2100	2600
79399	CLN2200/88-125	2200	2700
79400	CLN2300/92-125	2300	2800
79401	CLN2400/96-125	2400	2900
79402	CLN2500/100-125	2500	3000
79403	CLN2600/104-125	2600	3000
79404	CLN2800/112-125	2800	3300
79405	CLN3000/120-125	3000	3300



Section 9 – Lagging Adhesives

Conti® Adhesive/Activator/Primer

ORDERING NUMBER	DESCRIPTION	ITEM CODE	WEIGHT
FL-ADH-0.8	Adhesive	75019	4.8L
FL-ACT	Activator	75018	200 mL
FL-PR-0.75	Primer	73936	.8L

Each Conti® Adhesive is mixed with one Conti Activator. Refer to the usage chart below to calculate the number of cans required for your pulley. For sizes not included in the chart please contact Flexco Customer Service for assistance.

CONTI® SECUR COLD VULCANIZING CEMENT

Size and Type	Carton Quantity	Item Code	Weight Kgs
0.8 litre	12	75017	0.8
4.8 litre	1	75019	4.9
200 litre	1	75018	192.0
0.8 litre - White	12	73936	0.8
COVERAGE - 2.5 SQUARE METRES PER LITRE			

Note: Conti® Secur is not sold in kit form any longer - please order Adhesive and Activator separately

Note: 1 x 0.8L tin of Conti Secur (75017) requires 1 x 40ml Activator (70186). 1 x 4.8L tin of Conti Secur (75019) requires 6 x 40ml Activator (70186).

CONTI PLUS® ADHESION PROMOTER METAL PRIMER

Size and Type	Carton Quantity	Item Code	Weight (Kgs)
0.8 litre	6	70189	0.9
COVERAGE - 8 SQUARE METRES PER LITRE			

ACTIVATOR - 40 ml BOTTLES

Size and Type	Carton Quantity	Item Code	Weight (Kgs)
Activator RE (40 ml)	12	70186	0.1
Activator RFE - White (40 ml)	12	73951	0.1

CONTI® CLEANING SOLUTION

Size and Type	Carton Quantity	Item Code
1 Litre	1	62779
5 Litres	1	62780



Section 10 – Other Flexco Conveyor Products

Flexco provides many conveyor products that help your conveyors to run more efficiently and safely. These components solve typical conveyor problems and improve productivity. Here is a quick overview on just a few of them:

H-Type Primary Cleaner

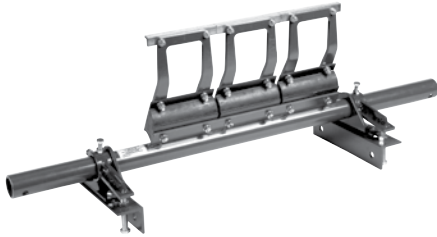

- Patented ConShear™ blade renews its cleaning edge as it wears
- Visual Tension Check™ for optimal blade tensioning and simple retensioning
- Quick and easy one-pin blade replacement Material Path Option™ for optimal cleaning and reduced maintenance

DRX Impact Beds

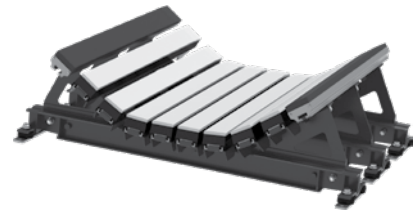

- Exclusive Velocity Reduction Technology™ to better protect the belt
- Slide-Out Service™ gives direct access to all impact bars for change-out
- Impact bar supports for longer bar life
- 4 models to custom fit to the application

MHS Secondary Cleaner



- Long-wearing tungsten carbide blades for superior cleaning efficiency
- Patented FormFlex™ cushions independently tension each blade to the belt for consistent, constant cleaning power
- Easy to install, simple to service
- Works with Flexco mechanical belt splices

PT Max™ Belt Trainer



- Patented “pivot & tilt” design for superior training action
- Dual sensor rollers on each side to minimize belt damage
- Pivot point guaranteed not to freeze up
- Available for topside and return side belts

Flexco Specialty Belt Cleaners



- “Limited space” cleaners for tight conveyor applications
- High Temp cleaners for severe, high heat applications
- A rubber fingered cleaner for chevron and raised rib belts
- Multiple cleaner styles in stainless steel for corrosive applications

Belt Ploughs

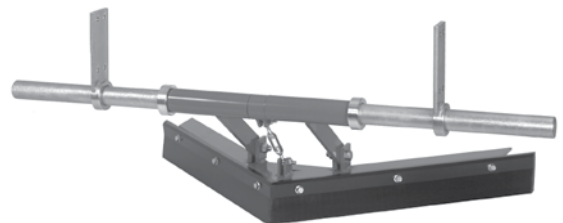

- A belt cleaner for the tail pulley
- Exclusive blade design quickly spirals debris off the belt
- Economical and easy to service
- Available in vee or diagonal models



Flexco (Aust.) Pty. Ltd • 10 Solent Circuit, Norwest • NSW, Australia, 2153 • Australia
Tel: 612-8818-2000 • Fax: 612-8824-6333 • E-mail: salesau@flexco.com

Visit www.flexco.com for other Flexco locations and products.

©2022 Flexible Steel Lacing Company. 10/25/22. For reorder: X3282

