

# Pocket Instruction Guide

Flexco<sup>®</sup> SR<sup>™</sup>  
Rivet Hinged<sup>™</sup>  
Fastening  
System



# Table of Contents

---

## Safety Checklist

1

---

## Proper Flexco® SR™ Selection Guidelines

2

Fastener Selection

3

Material Selection

4

Installation Method

4

Rivet Selection

5

Hinge Pin Selection

6

---

## Proper Belt Preparation

7-11

---

## Hammer Installation

12

MSRT Tool

12

MSRT8/9 Tool

20

SRTA Tool

27

---

## Power Installation

32

Power Source: *Powder Actuation*

Hilti DX 460-SR Powder Actuated Tool

32

Power Source: *Electric*

Flexco® Electric Powered Rivet Driver

40

Power Source: *Pneumatic*

Air Powered Rivet Driver

49

# Safety Checklist



## DANGER

 **Serious personal injury may result by failure to comply with the following:**

Prior to any work on your conveyors, make certain that the power has been turned off and the belt is locked out. Follow other safety precautions outlined in the operator's manual.



Be sure to wear all recommended safety equipment prior to engaging in any belt maintenance procedure.



## Proper Flexco® SR™ Selection Guidelines



### Proper Selection for the Flexco® SR™ Rivet Hinged Fastening System

*Flexco® SR Rivet Splice =  
Fastener Strip + Rivet + Pin + Installation Tool*

#### 1. Determine Belt Tension.

Most conveyor belting has a mechanical fastener rating. Care should be taken not to operate the belting or fasteners beyond their recommended ratings.

#### 2. Measure Belt Thickness.

Choose a fastener size which corresponds to belt thickness. If fasteners are to be countersunk, measure the belt thickness after skiving.

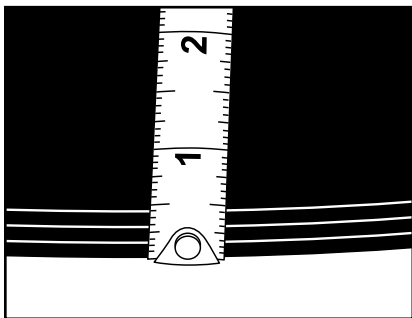

## Proper Flexco® SR™ Selection Guidelines

### 3. Measure the Diameter of the Smallest Pulley in your Drive.

For tail or take-up of the self-cleaning “wing type” pulley, 25% larger diameter dimensions are usually required. Only consider pulleys over which the belt makes at least a 90 degree wrap.

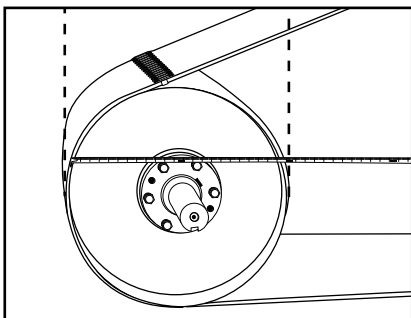

### 4. Choose the Fastener Size that is Appropriate for your Specification.

#### *Flexco® Rivet Hinged Fastener Selection Chart*

Fastener Size	For Belts With Mechanical Fastener Ratings Up To:	Belt Thickness Range	Recommended Min. Pulley Diameter	
			Operating Tension Under 100% of Belt Rating	Operating Tension Under 75% of Belt Rating
			kN/m	mm
R2	60	3-6	127	127
R5	79	6-11	230	175
R5-1/2	114	8-15	300	250
R6	140	10.5-17	450	400
R6LP	140	8-18	450	400
R8	263	10.5-17	450	400
R9	350	16-25.5	1050	1050

# Proper Flexco® SR™ Selection Guidelines

## 5. Select Material.

Choose the metal characteristics which best suit your application. Not all sizes are available in all metals.

### *Fastener Metals*

Fastener Material	Abrasion Resistance	Chemical Resistance	Rust Resistance	Magnetic	Spark-Free	Available Sizes
Galvanized Steel	Good	Poor	Fair	Yes	No	R2, R5, R5½, R6
300 Series Stainless Steel	Good	Good to Excellent	Excellent	Yes	No	R2, R5, R9
MegAlloy®	Excellent	Poor	Poor	Yes	No	R2, R5, R5½
RustAlloy®	Good	Good	Good	Yes	No	R5, R5½, R6, R8

## 6. Select Installation Method.

Flexco® SR fasteners can be hammer applied or choose a power installation option to speed installation time.

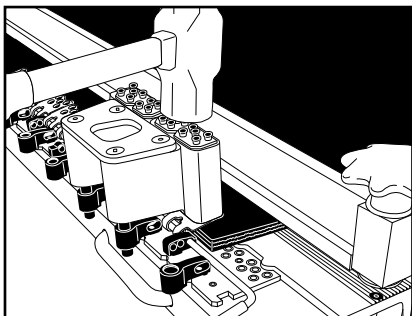

# Proper Flexco® SR™ Selection Guidelines

## 7. Select Rivets.

**Rivet Selection Chart**

Belt Thickness Range	Rivet Size	Rapid Loader™ Collated Rivet Color Code	
mm			
<b>R2</b>			
3-6	SRAA	N/A	
4-8	SRA		
7-10	SRB		
<b>R5</b>			
6-8	SRA	Red	
7-10	SRB	White	
9-11	SRC	Blue	
10.5-11	SRC/D	Orange	
<b>R5½ &amp; R6LP</b>			
8-9	SRB	White	
8-10.5	SRC	Blue	
10-12	SRC/D	Orange	
11-13.5	SRD	Green	
13-15	SRE	Purple	
14-16.5	SRF*	Yellow	
16-18	SRG*	Black	
<b>R6</b>			
9-11	SRC/D	Orange	
10.5-13	SRD	Green	
12-14	SRE	Purple	
13.5-16	SRF	Yellow	
15-17	SRG	Black	
<b>R8</b>			
10.5-11	SRC/D	Orange	
10.5-13	SRD	Green	
12-14	SRE	Purple	
13.5-16	SRF	Yellow	
15-17	SRG	Black	
<b>R9</b>			
16-17	SRG	Black	
16.5-19	SRH	Grey	
18-21	SRI	Lt. Blue	
20-22	SRJ**	Brown	
21-24	SRK**	Tan	
23-25	SRL**	Teal	

\* Applies to RAR6LP only.

\*\* Use with 19 mm diameter hinge pin.



Selection

## Proper Flexco® SR™ Selection Guidelines

---

### 8. Select Hinge Pin.

**AC – Bare Armored Cable:** Heavy-duty, long-wearing pin popular in underground mining applications. Armor wrapping protects interior wires.

**ACS – Bare Armored Stainless Steel Cable:** The same advantages as bare armored cable plus corrosion resistance.

**NAC – Nylon Covered Armored Cable:** Combines a durable armored steel wrap with a nylon covering for smooth operation and long service life. Nylon covering helps reduce pin migration and prolong pin life. Not recommended in wet, abrasive applications.

**NC – Nylon Covered Steel Cable:** Nylon covering helps reduce pin migration and prolong pin life. Not recommended in wet, abrasive applications. For R2 and R5 only.

**NCS – Nylon Covered Stainless Steel Cable:** For greater corrosion resistance. Not recommended in wet, abrasive applications. For R2 and R5 only.

**SC – Bare Steel Cable:** Recommended for abrasive or gritty material conveyance.

**SSC – Bare Stainless Steel Cable:** For conditions where corrosion attacks steel pins. For R2 and R5 only.



## Proper Belt Preparation

**Improve workplace safety and maximise belt conveyor performance by following proper belt preparation practices.**

### BELT LIFTING

#### *A Safer Way to Lift a Belt*

Lifting a conveyor belt out of the way to do belt repair and maintenance can be a difficult and hazardous job. To optimise worker safety when replacing worn idler rollers or to lift and flatten belt for a splicing station, avoid pry bars and manual lifting with a Flex-Lifter™ Belt Lifter.

- Highest safe lift rating available: 1810 kg (4,000 lbs.)
- Can safely lift a tensioned belt up to the stated ratings
- Works on all types of belt, including troughed, flat topside, or return side belts
- Easily transported to the job site

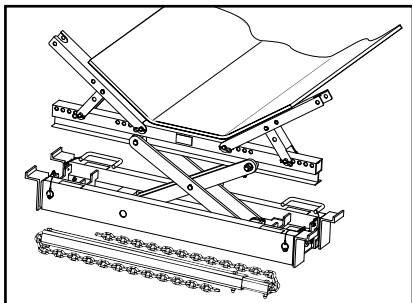

## Belt Preparation

---

### BELT CLAMPING

#### *A Safer Way to Secure a Belt*

Avoid the problems and potential dangers associated with homemade devices such as c-clamps or lumber and chains. The Far-Pul™ HD® Belt Clamp is specially designed to properly secure a belt and clamp it for safe belt conveyor maintenance.

- Built-in safety features allow a secure belt grip up to 25 mm (1 inch) thick
- Provides even clamping tension across entire belt width
- Load capacity up to 2.7 metric tons (3 tons) when used with two 1/4 metric ton (1-1/2 ton) come-a-longs

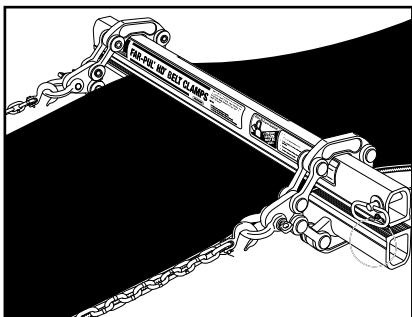

## Belt Preparation

---

### BELT SQUARING

Accurate squaring of belt ends is essential to optimal positioning of the belt splice and provides for better fastener performance. Unevenly squared belts can lead to uneven belt tensions, belt mistracking, spillage issues, and ultimately to splice failure.

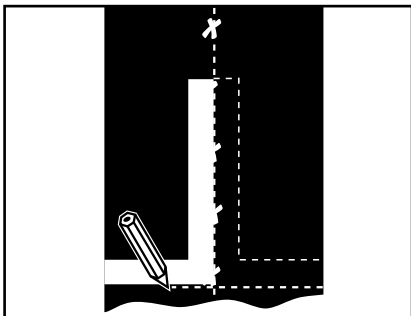

**Belt Preparation**

## Belt Preparation

---

### BELT CUTTING

#### *A Safer Way to Cut a Belt*

Utility knives can't provide the same level of safety, speed, and accuracy when cutting belts. And clean, square cut belt ends provide for optimal splice installation. To minimize the danger of accidental injury during the cutting process, choose a Flexco belt cutter.

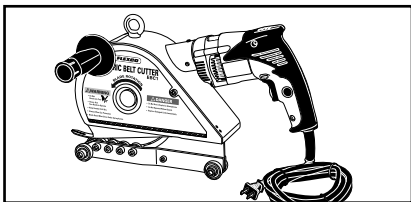

**Electric Belt Cutter** – Power assisted belt cutting for rubber belts up to 50 mm (2”) thick.

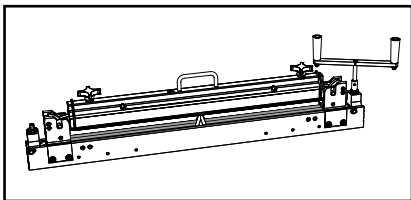

**900 Series\* Belt Cutter** – Manually operated belt cutter for safe, accurate cuts up to 38 mm (1-1/2”) thick.

\*Patent Numbers: US US8132489B2,  
International WIPO WO2009006619A1

## Belt Preparation

---

### BELT SKIVING

#### *A Safer Way to Skive a Belt*

Whenever possible, Flexco recommends skiving the belt in order to countersink mechanical fasteners. Skiving reduces the fastener profile on the belt, resulting in improved fastener/cleaner compatibility and increased fastener service life. The FSK™ Belt Skiver safely removes top cover for installation of recessed splices.

- Blade safely enclosed during skiving operations
- Portable and lightweight
- Ideal for rubber-covered belts with top covers 4.5 mm (3/16") thick or more

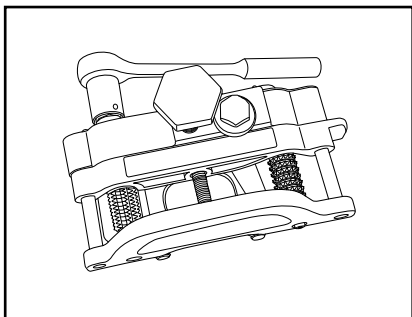



## Hammer Installation: Installing Flexco® R2, R5, R5½, R6 Fasteners with MSRT Installation Tool

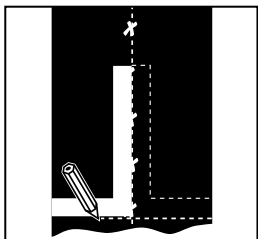

### 1. Square belt using centerline method.

Cut belt at least 100 mm (4") behind old splice using a Flexco belt cutting tool. Skive belt when top cover permits.

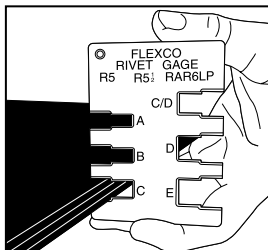

### 2. Measure belt thickness from cut edge using gauge or tape measure. If fasteners are to be countersunk, measure belt thickness after skiving. Select correct size SR rivets for your belt thickness.

## MSRT Tool

---

3. Place tool on wooden board, width of the conveyor framework, for support. Lift and turn gauge pin guide to correct fastener size.

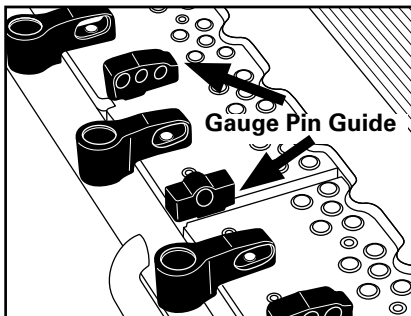

4. Center fastener strip(s) on tool, Flexco stamp facing up. Holes on fasteners and anvil plate must line up. Insert gauge pin through guides and fastener loops.

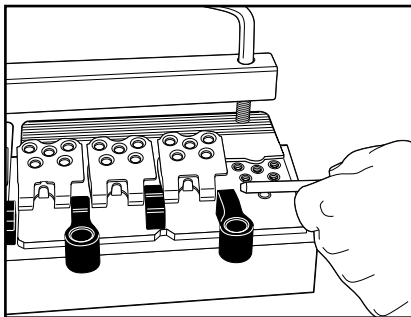

## MSRT Tool

---

5. Center belt in fastener strip. Look through viewports, belt end should be tight against belt stops. Tighten hold down bar to secure belt.

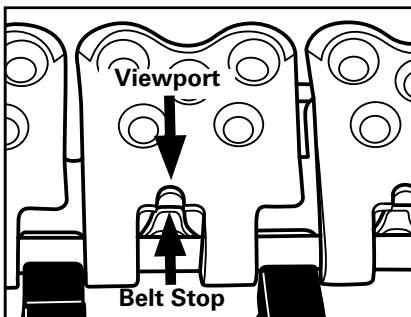

6. Set all fastener top plates with hammer blows. Place SR700 guide blocks at each end of the fastener strip and tighten clamping screws. Spray guide block with SL5 Silicone.

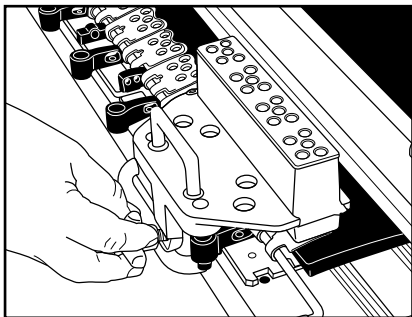



## MSRT Tool

---

### Individual Rivets.

7A. Load guide block with individual rivets. Reduce installation time by adding guide blocks across tool.

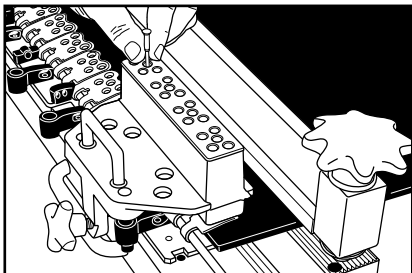

### Rapid Loader™ Collated Rivets.

*Reduce installation time using Rapid Loader™ Collated Rivet Strips.*

7B. Insert pilot nails into guide block holes. Using a hammer, hit collated rivets to release rivets from plastic. Remove plastic from guide block. If a shorter strip is needed, break off extra plates by bending strip at checkpoints.

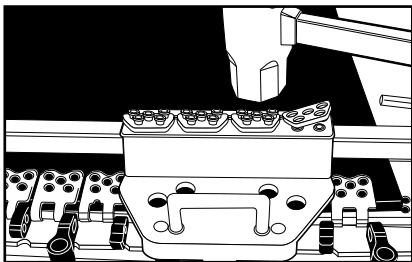

## MSRT Tool

---

8. Using the Drive Rod, push rivets into guide block.

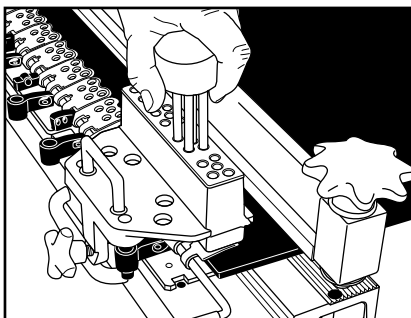

### Guide Block Sequence for Single and Multiple Rivet Driving

- ① Drive one full block on both ends of fastener strip.
- ② Drive one full block in the center of the fastener strip.
- ③ On both sides, split the difference between the middle and end and drive one full block.
- ④ Drive remaining rivets.

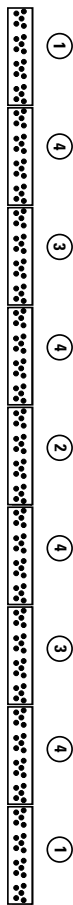

## MSRT Tool

---

9. Drive rivets following sequencing on page 17.

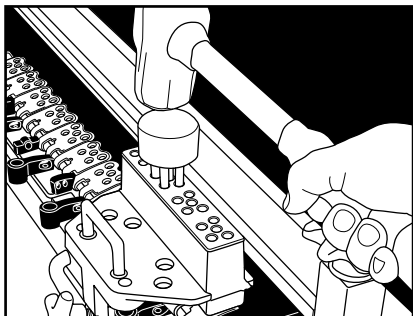

10. Remove guide blocks. Using a 1.8 kg (4 lb.) hammer, set all rivets. The belt should pucker around the edges of the fasteners.

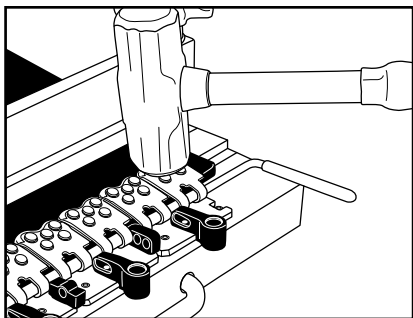

## MSRT Tool

---

11. Remove gauge pin and belt clamp bar. Lift belt off tool and knock off any pilot nails still attached. Turn tool over and remove all nails.

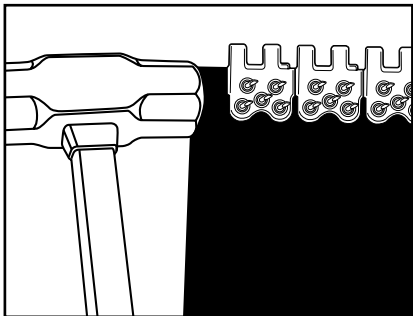

12. Repeat steps 1-11 on other belt end. Bring belt ends together and insert hinge pin. Notch trailing edge of belt only. Splice is complete.

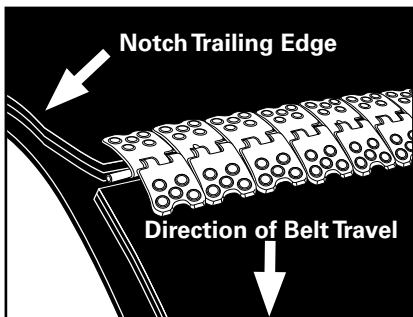



## Hammer Installation: Installing Flexco® R8 or R9 Fasteners with MSRT8 or MSRT9 Installation Tool

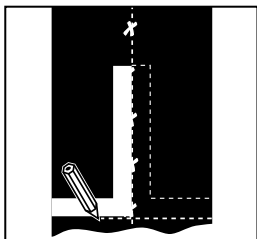

### 1. Square belt using centerline method.

Cut belt at least 100 mm (4") behind old splice using a Flexco belt cutting tool. Skive belt when top cover permits.

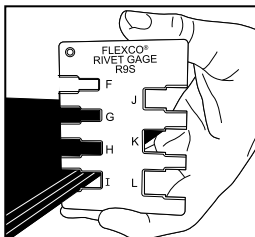

2. Measure belt thickness from cut edge using gauge or tape measure. If fasteners are to be countersunk, measure belt thickness after skiving. Select correct size SR rivets for your belt thickness.

## MSRT8/9 Tool

3. Place tool on wooden board, width of the conveyor framework, for support. Lift and turn gauge pin guide to correct fastener size. No adjustment necessary for R9.

\*For R8 installation, confirm gauge pin guide is set to R6/R8 mark.

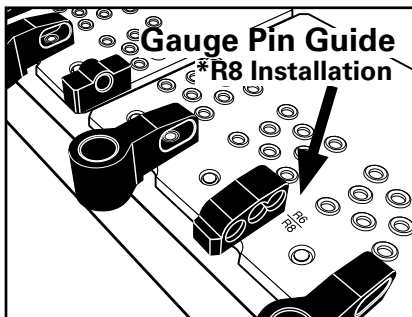

4. Center fastener strips on tool, Flexco stamp facing up. Holes on fasteners and anvil plate must line up. Insert gauge pin through guides and fastener loops.

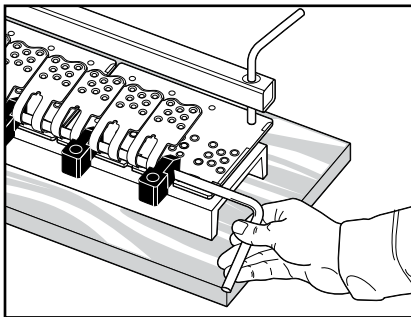

## MSRT8/9 Tool

- Center belt in fastener strip. Look through viewports, belt end should be tight against belt stops on fastener or on tool. Tighten hold down bar to secure belt.

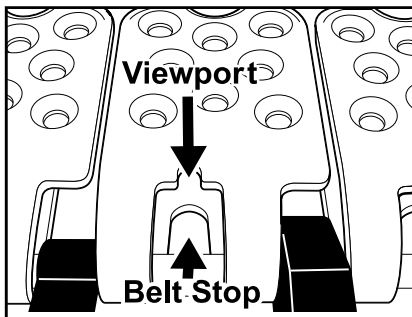

- Set all fastener top plates with hammer blows. Place guide blocks at each end of the fastener strip and tighten clamping screws. Spray guide block with SL5 Silicone.

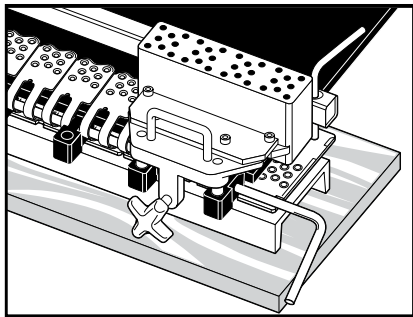



## MSRT8/9 Tool

---

### Individual Rivets.

7A. Load guide block with individual rivets. Reduce installation time by adding guide blocks across tool.

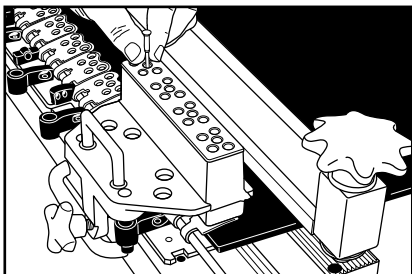

### Rapid Loader™ Collated Rivets.

*Reduce installation time using Rapid Loader™ Collated Rivet Strips.*

7B. Insert pilot nails into guide block holes. Using a hammer, hit collated rivets to release rivets from plastic. Remove plastic from guide block. If a shorter strip is needed, break off extra plates by bending strip at checkpoints.

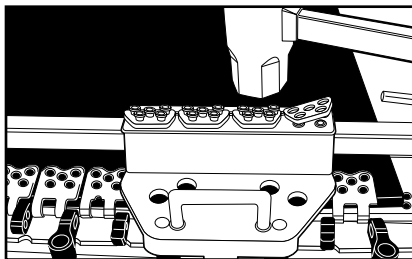

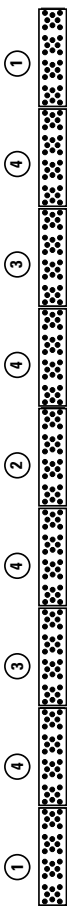

**9A.** Using the Drive Rod, push rivets into guide block.

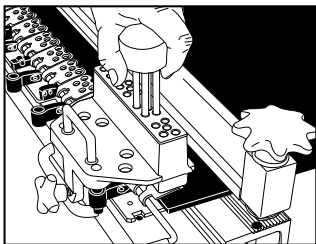

**9B.** Drive rivets following the Guide Block and Single Rivet or Multiple Rivet driving sequences.

### Guide Block Sequence for Single and Multiple Rivet Driving

- ① Drive one full block on both ends of fastener strip.
- ② Drive one full block in the center of the fastener strip.
- ③ On both sides, split the difference between the middle and end and drive one full block.
- ④ Drive remaining rivets.

## MSRT8/9 Tool

**10A.** For **Single Rivet** driving, follow number sequence as illustrated below for driving rivets.

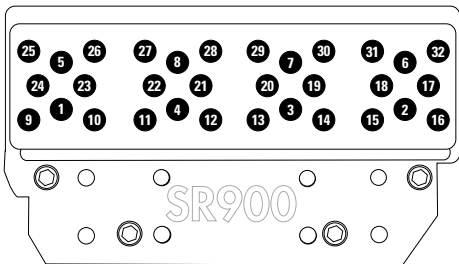

**10B.** For **Multiple Rivet** driving, use a 2.7 kg (6 lb.) hammer and SR859 drive rod, follow number sequence as illustrated below for driving.

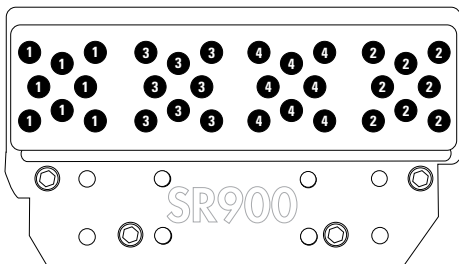

## MSRT8/9 Tool

11. Remove gauge pin and belt clamp bar. Lift belt off tool and knock off any pilot nails still attached. Turn tool over and remove all nails.

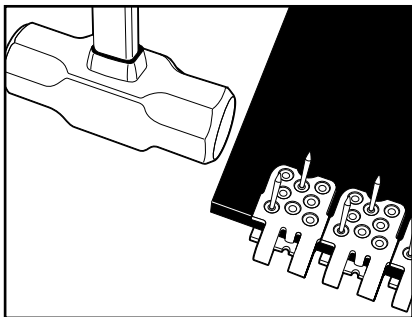

12. Repeat steps 1-11 on other belt end. Bring belt ends together and insert hinge pin. Notch trailing edge of belt only. Splice is complete.

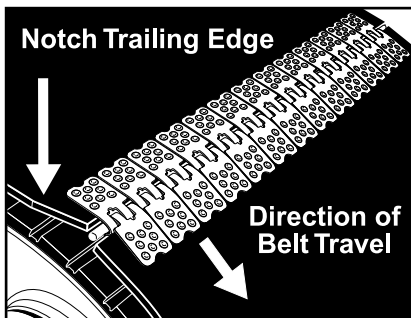

## Hammer Installation: Installing Flexco® R2, R5, R5½, R6 Fasteners with SRTA Installation Tool

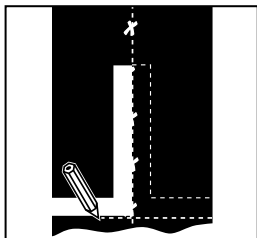

### 1. Square belt using centerline method.

Cut belt at least 100 mm (4") behind old splice using a Flexco belt cutting tool. Skive belt when top cover permits.

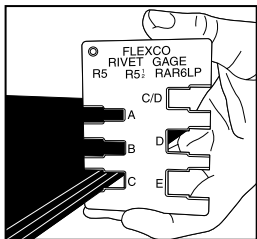

### 2. Measure belt thickness from cut edge using gauge or tape measure.

If fasteners are to be countersunk, measure belt thickness after skiving. Select correct size SR rivets for your belt thickness.

## SRTA Tool

3. Place tool on wooden board, width of the conveyor framework, for support. Lift and turn gauge pin guide to correct fastener size.

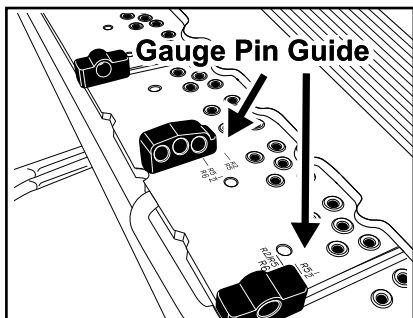

4. Center fastener strips on tool, Flexco stamp facing up. Holes on fasteners and anvil plate must line up. Insert gauge pin through guides and fastener loops.

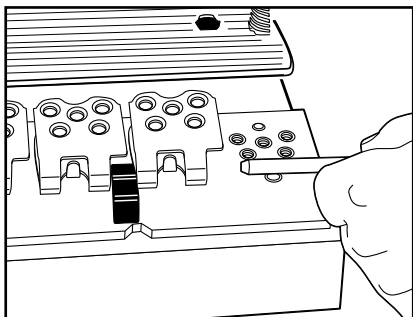

## SRTA Tool

---

5. Center belt in fastener strip. Look through viewports, belt end should be tight against belt stops. Tighten hold down bar to secure belt.

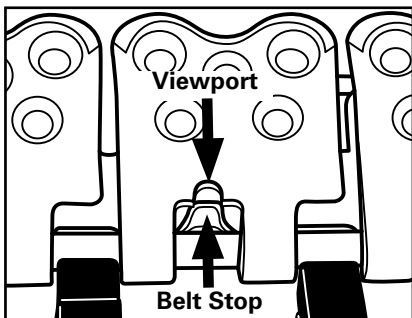

6. Set fastener top plates with hammer blows. Remove drive rod from SR50. Load tool with rivets. Replace drive rod.

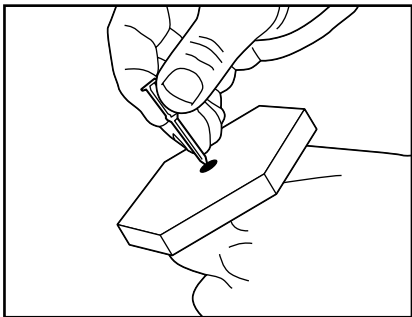

## SRTA Tool

---

7. Using a 0.9 kg (2 lb.) hammer, drive a rivet into the center hole of each end plate, then the middle plate. Drive remaining rivets.

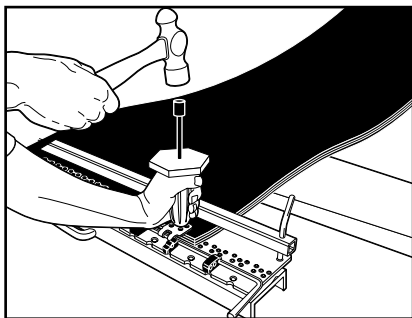

8. Set all rivets and plate edges with firm hammer blows. The belt should pucker around the edges of the fastener.

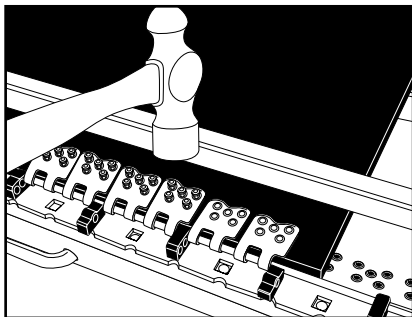



## SRTA Tool

---

9. Remove gauge pin and belt clamp bar. Lift belt off tool and knock off any pilot nails still attached. Turn tool over and remove all nails.

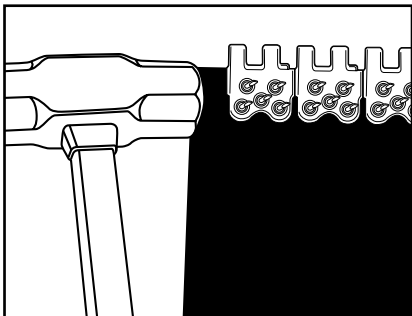

10. Repeat steps 1-9 on other belt end. Bring belt ends together and insert hinge pin. Notch trailing edge of belt only. Splice is complete.

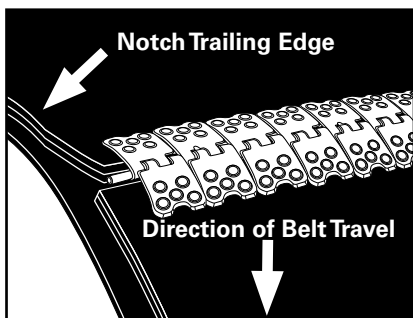



## Powered Installation: Power Source: Powder Actuation— Flexco® SR™ Rivet Hinged Installation with the Hilti DX 460-SR Powder Actuated Tool

For use with Rapid Loader™ Collated Rivets with washers. See rivet selection chart below. In areas of overlap, to select the proper rivet, choose the shorter rivet for softer, compressible belts and the longer rivet for hard belts.

### Power Setting and Booster Selection Chart

Rivet Size	Booster Color	Power Setting	
		Steel	Stainless Steel
A	Green	1.5-2.5	2.0-3.0
B	Green	1.5-2.5	2.0-3.0
C	Green	1.5-3.0	2.0-3.5
C/D	Green	1.5-3.0	2.0-3.5
D	Green	2.0-3.5	2.0-3.5
E	Green	2.0-3.5	2.0-3.5
F	Green	2.0-3.5	2.0-3.5
G	Green	2.0-3.5	2.0-3.5
G	Yellow	1.5-3.0	2.0-3.5

NOTE: For installation of rivets larger than "G", contact your local Flexco representative or Flexco customer service.

## Hilti DX 460-SR

**1. Square belt using centerline method.** Cut belt at least 100 mm (4") behind old splice using a Flexco belt cutting tool. Skive belt when top cover permits.

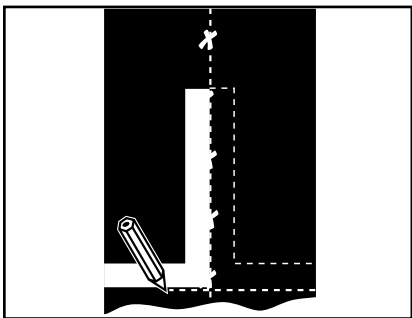

**2. Measure belt thickness from cut edge using gauge or tape measure.** If fasteners are to be countersunk, measure belt thickness after skiving. Select correct size SR rivets *with washers* for your belt thickness.

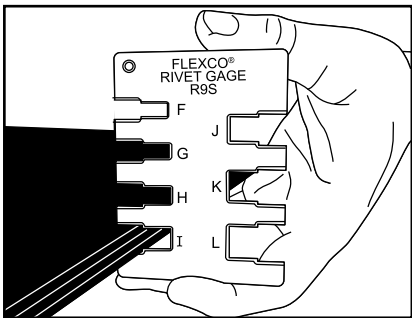

3. Place tool on wooden board, the width of the conveyor framework, for support when using the MSRT tool. Adjust gauge pin guide to the correct fastener size.

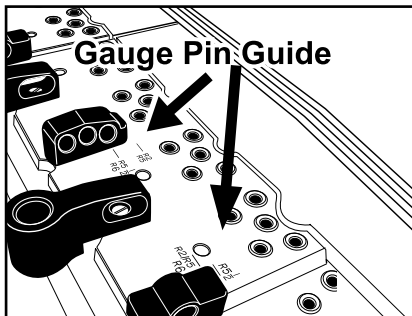

4. Center fastener strip on tool, Flexco stamp facing up. The holes in the fasteners and anvil plate must line up. Insert gauge pin through guides and fastener loops.

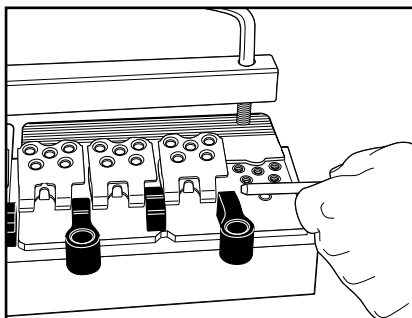

## Hilti DX 460-SR

---

5. Insert belt end into fastener strip; center belt in strip. Look through viewports; belt ends should be tight against belt stops. Tighten hold down bar to secure belt.

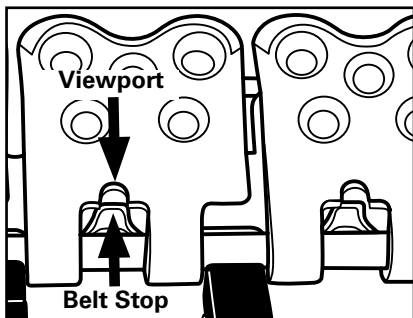

6. Use the steel guide blocks designed for use with the Hilti DX 460-SR Powder Actuated tool. Reduce installation time by adding additional guide blocks across the tool.

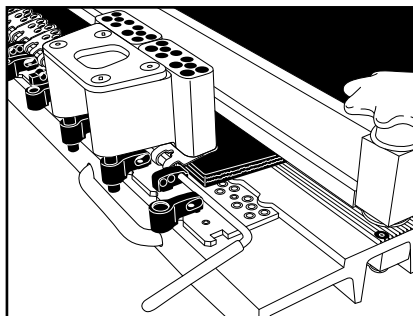

7. Load guide blocks with Rapid Loader™ Collated Rivets *with washers*. **WARNING: Without washers, misfires will occur.** If a shorter strip is needed, break off extra rivets by bending strip at checkpoint.

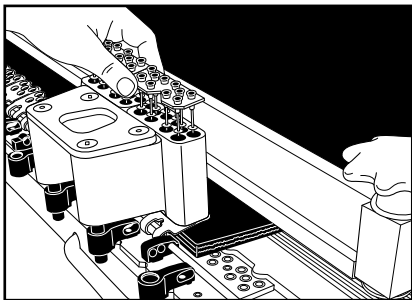

8. Using a hammer, hit the Rapid Loader Collated Rivets to release all rivets from plastic. Remove plastic from guide block and discard. Check the “booster and power lever chart” on page 32 of these instructions.

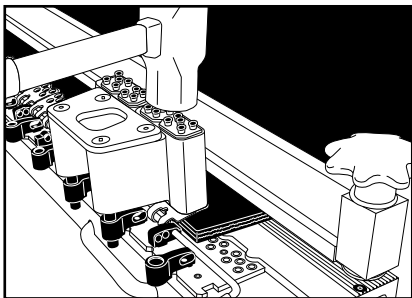

9. Set **all** fastener top plates with hammer blows. Place metal guide block(s) at either end of the fastener strip. Drive rivets into two holes closest to fastener loops (1). Drive rivet into center (2) then into 2 holes away from fastener loop (3). While driving rivets, keep guide blocks as level as possible to avoid misfires. *For Rivet driving for R8/R9 fasteners, see pages 24 and 25.*

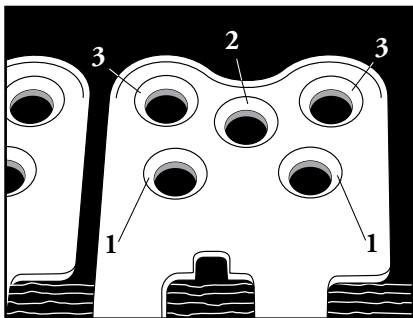

10. Adjusting Power Setting for the Hilti DX 460-SR: Depress lever and rotate power setting dial to recommended power setting. Release lever to lock dial.

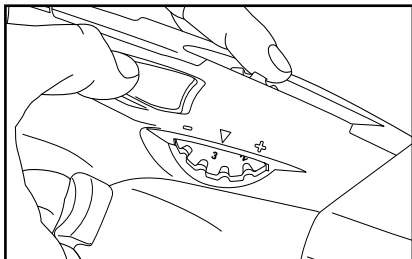

## Hilti DX 460-SR

---

11. Insert the Hilti driver nose directly into the counter bore of the guide block. Press the tool firmly and completely into the guide block. Pull the trigger to drive the rivet.

Start with the lowest booster power level and the tool set at the lowest power setting shown on the chart (*see page 32*). If rivet is not fully driven into fastener, use hammer to fully drive rivets. Increase power level and repeat until the rivet is properly driven into fastener. Use a more powerful booster if necessary.

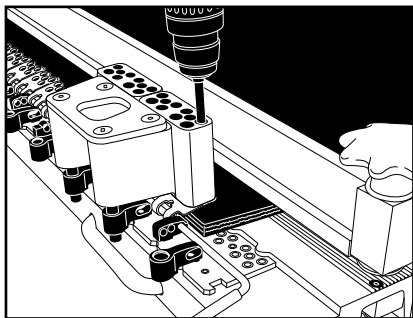



12. Remove guide block(s) and make sure rivets are completely set. Hammer any loose rivets into fasteners to properly set rivets. Hammer scalloped edges of fasteners to set edges into belt. Drive remaining rivets following sequencing for 5-rivet pattern on page 17 or for 8-rivet pattern on page 24.

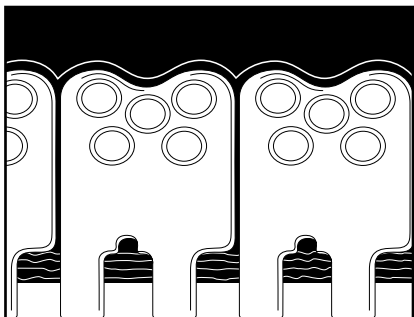

13. Repeat steps 1-12 on other belt end. Bring belt ends together and insert hinge pin. Notch trailing edge of belt only. Splice is complete.

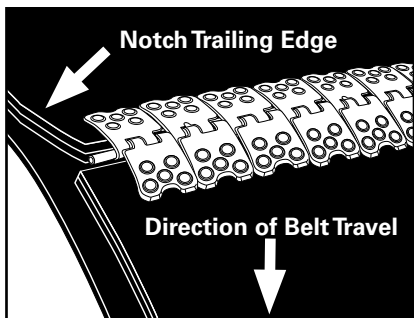



## Powered Installation: Power Source: Electric – Flexco® SR™ Rivet Hinged Installation with the Flexco® Electric Powered Rivet Driver

### **WARNING**

Follow all maintenance and safety precautions that are noted in the Hitachi H45FRV manual included in the kit. Flexco recommends a trial drive prior to production installation.

Use of this driver will vary with the length of the rivet and the type of belt you are using.

- 1. Square belt using centerline method.** Cut belt at least 100 mm (4") behind old splice using a Flexco belt cutting tool. Skive belt when top cover permits.

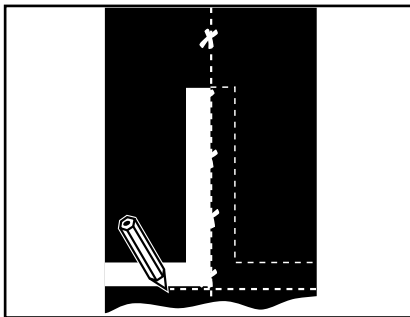

## Flexco® Electric Powered Rivet Driver

2. Measure belt thickness from cut edge using gauge or tape measure. If fasteners are to be countersunk, measure belt thickness after skiving. Select correct size SR rivets for your belt thickness.

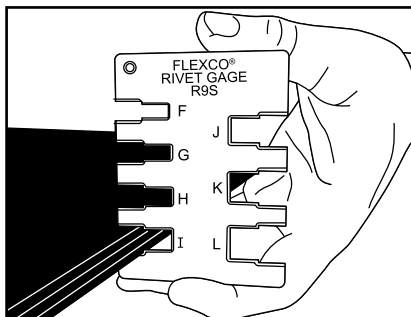

3. Place tool on wooden board, width of the conveyor framework, for support. Lift and turn gauge pin guide to correct fastener size.

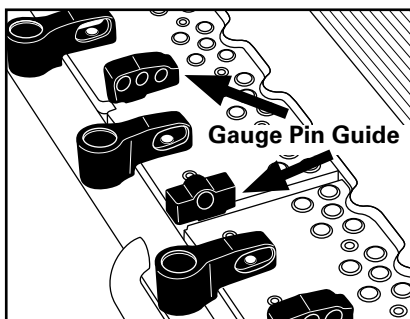

## Flexco® Electric Powered Rivet Driver

---

4. Center fastener strip on tool, Flexco stamp facing up. Holes on fasteners and anvil plate must line up. Insert guide pin through guides and fastener loops.

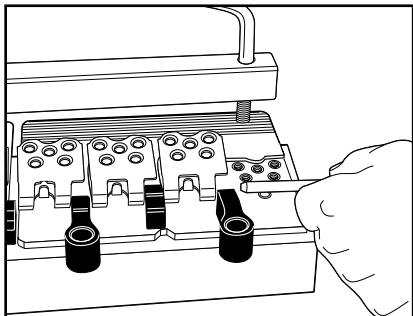

5. Center belt in fastener strip. Look through viewports, belt end should be tight against belt stops. Tighten hold down bar to secure belt.

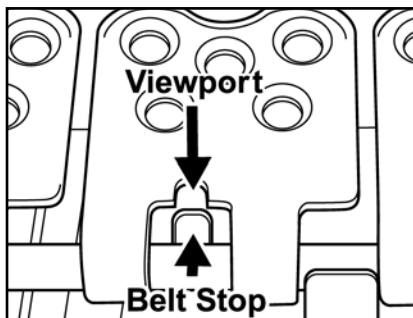

## Flexco® Electric Powered Rivet Driver

---

6. Set all fastener top plates with hammer blows. Place SR700 guide blocks at each end of the fastener strip and tighten clamping screws. **Note: Spray guide block with SL5 Silicone.**

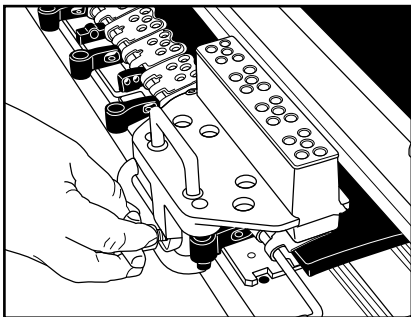

Electric

## Flexco® Electric Powered Rivet Driver

---

### Individual Rivets.

7A. Load guide block with individual rivets. Reduce installation time by adding guide blocks across tool.

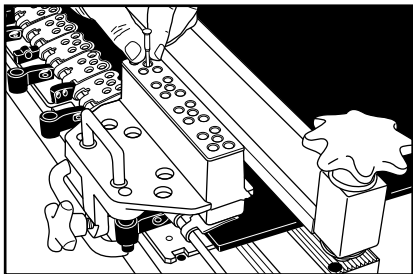

### Rapid Loader™ Collated Rivets.

*Reduce installation time using Rapid Loader™ Collated Rivet Strips.*

7B. Insert pilot nails into guide block holes. Using a hammer, hit collated rivets to release rivets from plastic. Remove plastic from guide block. If a shorter strip is needed, break off extra plates by bending strip at checkpoints.

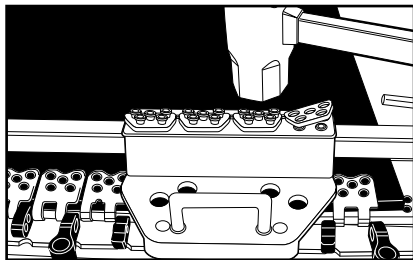

## Flexco® Electric Powered Rivet Driver

---

8. Using the SR759, push rivets into guide block.

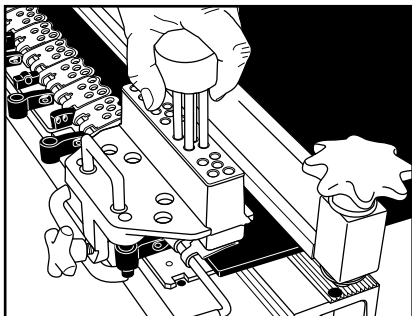

Electric

## Flexco® Electric Powered Rivet Driver

---

9. Adjust setting dial for rivet size – see chart below. Insert the punch directly into the SR700 Guide Block. Keeping the tool perpendicular to the base, pull the trigger to fire the driver. Push down on the driver slightly and maintain force on the driver until you feel the rivet set. This should take approximately 1 to 2 seconds per rivet depending on the length of the rivet and the type of belt.

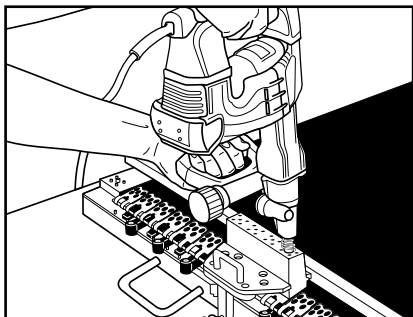

**Note:** Tool settings will require adjustment for variations in belt thickness and construction.

### *Tool Setting Guidelines*

Tool Setting	Rivet size range
2	A,B
3	A,B,C
4	C,C/D,D
5	D & up





## Flexco® Electric Powered Rivet Driver

---

10. Drive rivets into holes in the sequence shown below. For R8/R9 sequencing see page 25.

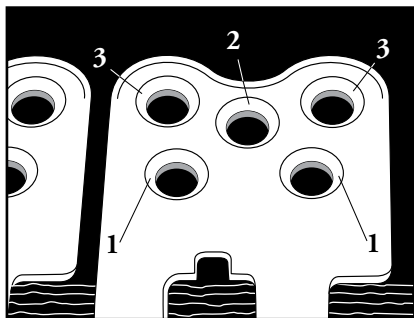

11. Remove guide block(s) and make sure rivets are set completely. Drive remaining rivets following sequencing for 5-rivet pattern on page 17 or for 8-rivet pattern on page 24.

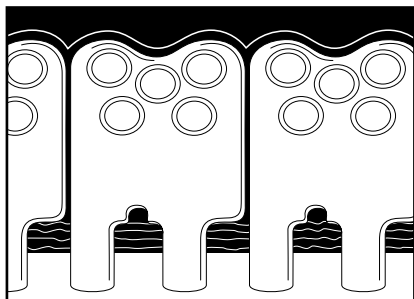

Electric

## Flexco® Electric Powered Rivet Driver

---

12. Repeat steps 1-11 on other belt end. Bring belt ends together and insert hinge pin. Notch trailing edge of belt only. Splice is complete.

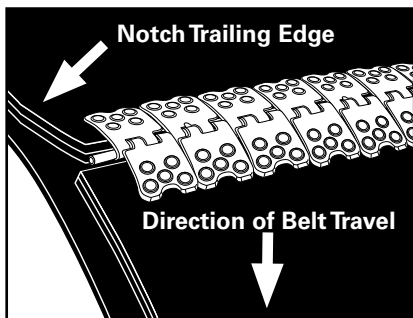

## Powered Installation: Power Source: Pneumatic— Flexco® SR™ Rivet Hinged Installation with the Air Powered Rivet Driver



### **WARNING**

Never actuate tool unless Drive Rod is inside Guide Block and contacting a Rivet, personal injury or damage to tool could occur.

- Always use clean, dry, regulated compressed air.
- Do not operate tool with air pressure greater than 90 psi.
- Keep tool clean and dry.
- Lubricate tool with Air Tool Oil daily.

### Assembly

1. Insert Drive Rod into Retainer Spring.

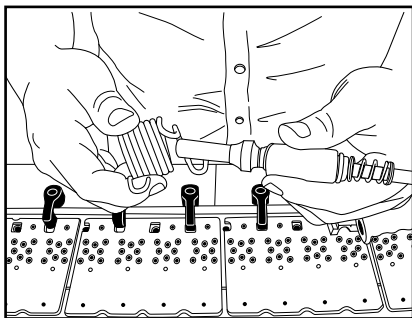

## Air Powered Rivet Driver

---

2. Thread Retainer Spring onto nose of Tool.

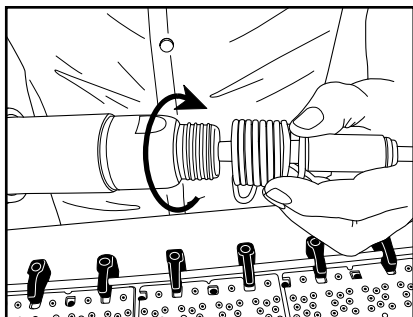

3. Connect Air Supply.

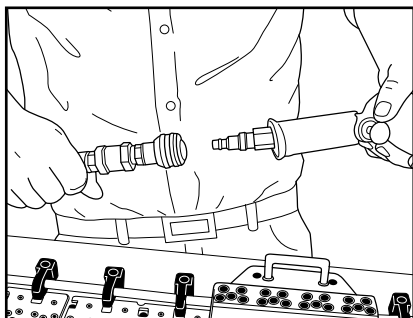

## Air Powered Rivet Driver

---

**4. Square belt using centerline method.** Cut belt at least 100 mm (4") behind old splice using a Flexco belt cutting tool. Skive belt when top cover permits.

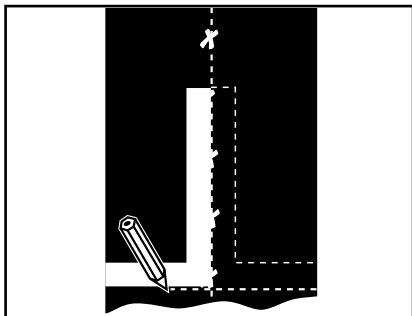

**5. Measure belt thickness from cut edge using gauge or tape measure.** If fasteners are to be countersunk, measure belt thickness after skiving. Select correct size SR rivet for your belt thickness.

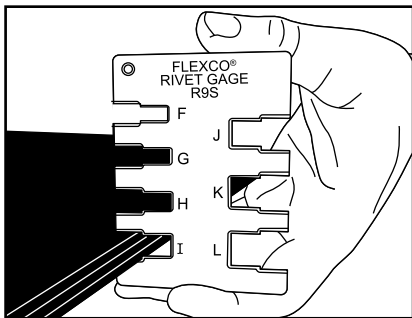

## Air Powered Rivet Driver

---

### Operation

6. Place tool on wooden board, width of the conveyor framework, for support. Lift and turn gauge pin guide to correct fastener size.

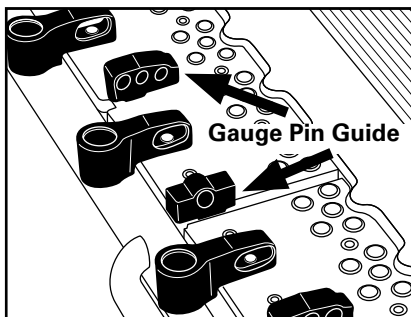

7. Center fastener strip on tool, Flexco stamp facing up. Holes on fasteners and anvil plate must line up. Insert gauge pin through guides and fastener loops.

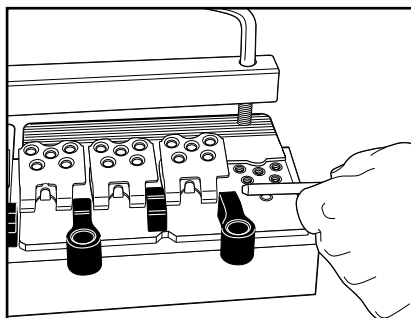

## Air Powered Rivet Driver

---

8. Center belt in fastener strip. Look through viewports, belt end should be tight against belt stops. Tighten hold down bar to secure belt.

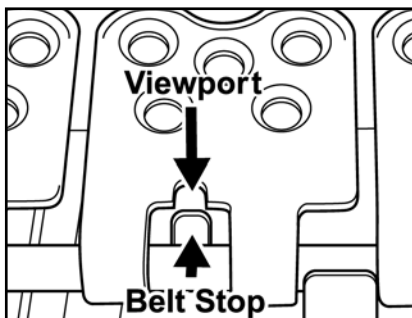

9. Set all fastener top plates with hammer blows. Place SR700 guide blocks at each end of the fastener strip and tighten clamping screws. **Note: Spray guide block with SL5 Silicone.**

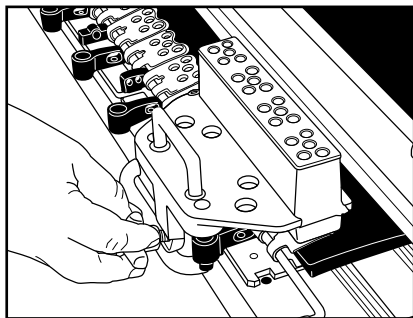

## Air Powered Rivet Driver

---

### Individual Rivets.

**10A.** Load guide block with individual rivets. Reduce installation time by adding guide blocks across tool.

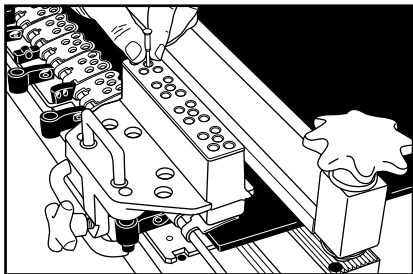

### Rapid Loader™ Collated Rivets.

*Reduce installation time using Rapid Loader™ Collated Rivet Strips.*

**10B.** Insert pilot nails into guide block holes. Using a hammer, hit collated rivets to release rivets from plastic. Remove plastic from guide block. If a shorter strip is needed, break off extra plates by bending strip at checkpoints.

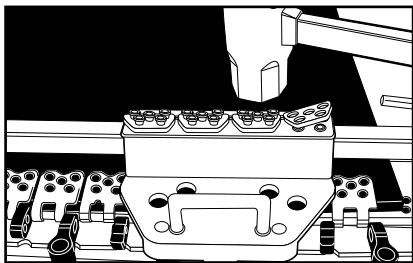



## Air Powered Rivet Driver

---

11. Using the Drive Rod, push rivets into guide block.

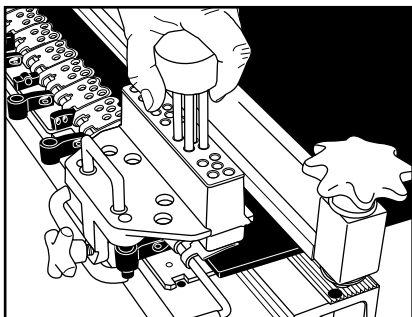

### **WARNING**

Never actuate tool unless Drive Rod is inside Guide Block and contacting a Rivet, personal injury or damage to tool could occur.

12. Insert Drive Rod into Guide Block.

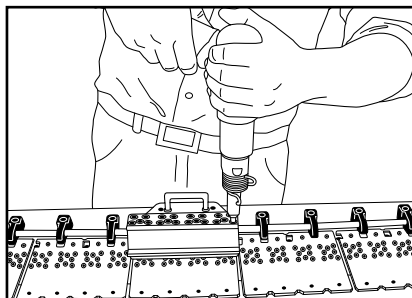

## Air Powered Rivet Driver

---

13. Actuate trigger on tool to drive rivet.  
Drive rivet into belt. Do not overdrive.

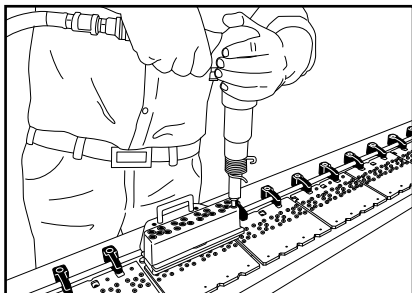

14. Drive rivets into the center hole of both end plates (1). This will anchor fastener strip in position. Continue to drive all remaining rivets into holes in the sequence shown below. *For R8/R9 sequencing see page 25.*

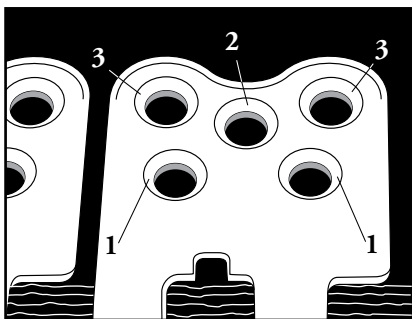

## Air Powered Rivet Driver

---

15. Remove guide block(s) and make sure rivets are set completely. Drive remaining rivets following sequencing for 5-rivet pattern on page 17 or for 8-rivet pattern on page 24.

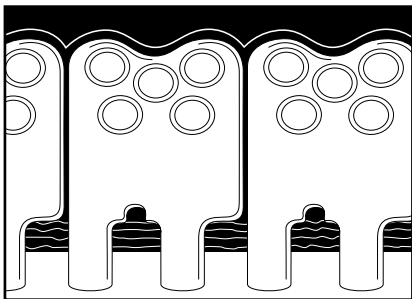

16. Repeat steps 1-15 on other belt end. Bring belt ends together and insert hinge pin. Notch trailing edge of belt only. Splice is complete.

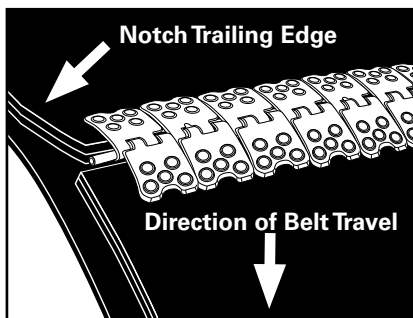

## Notes

---

## Notes

---

## Notes

---

## Notes

---

## Notes

---



## Notes

---

# Flexco Belt Cleaning Systems



**MMP Medium Mine-Duty  
Precleaner**



**MHS Heavy-Duty  
Secondary Cleaner**

*Turn to Flexco for a complete selection of belt cleaning solutions including precleaners, secondary cleaners, and specialty cleaning products.*



**U-Type®  
Secondary Cleaner**



**MDWS DryWipe  
Secondary Cleaner**

New Door No. 51 • Anna Salai, Nagalkeni • Pammal Village  
Chennai - 600 044 • Tamil Nadu • India

Tel: +91-44-4856-6762 • E-mail: [info.india@flexco.com](mailto:info.india@flexco.com)

Web: [www.flexco.com](http://www.flexco.com)

©2014 Flexible Steel Lacing Company.

Flexco®, Far-Pul™, HD®, Eliminator®, Mineline®, U-Type®, are  
registered trademarks. Hilti® is a registered trademark of Hilti, Inc.  
04-11-19. For Reorder: X3012

