

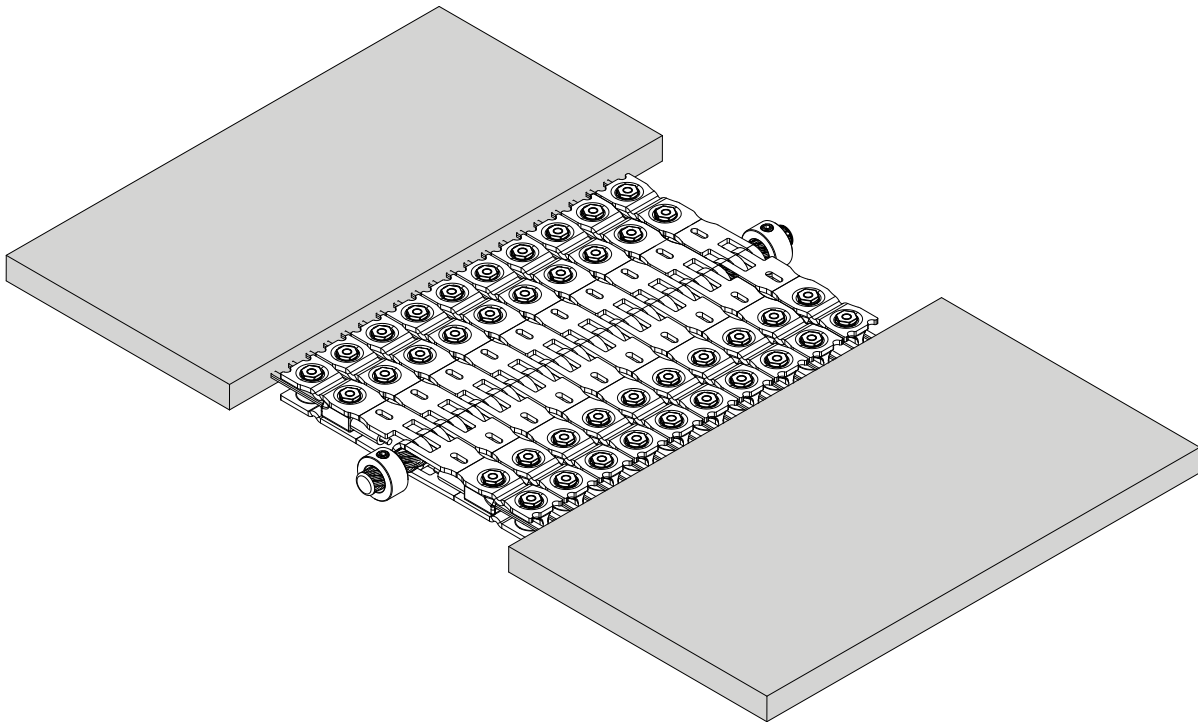

# FXC™ Steel Cord Belt Fastening System Installation Manual



## Disclaimer

Please note whether conveying material or pulling a belt onto the conveyor system, the FXC mechanical belt fastener is designed solely for temporary splicing purposes. Inspect all sides of the FXC mechanical belt fastener and the entire area of the temporary splice prior to each use for any signs of damage or wear including but not limited to; splice separation/elongation between belt ends, fastener plate damage, hinge pin damage, missing/damaged components (bolts, nuts, ferrules). Remove splice immediately if these conditions or any other signs of wear, deterioration, or separation are present in order to avoid failure of the temporary splice. Splice failure can lead to personal injury and/or property damage. As with belting and vulcanized splices, overloading, improper installation, or misuse of the FXC mechanical belt fastener may shorten the operating lifespan of this temporary splice.

Patents: [www.flexco.com/patents](http://www.flexco.com/patents)

# Table of Contents

Tools Required and Parts List ..... 2-3

General Safety Rules..... 4-5

Belt Preparation ..... 6-9

Splice Assembly ..... 10-16

Splice Belt Cover..... 17

## Tools List

### Customer Supplied:

### Flexco Supplied: (Tool Kit Sold Separately)

Tape Measure

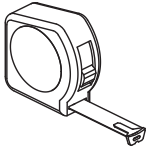

Angle Grinder

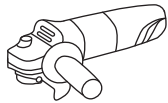

Straight Edge



Oscillating Tool with Starlock

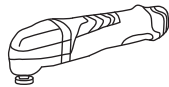

Impact Driver  
1/2 (13mm)

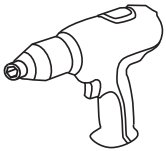

Cut-off Wheel  
(optional)

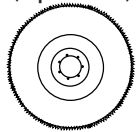

Hose Clamp  
(optional)

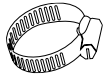

Belt Marking Pen



Round Blade

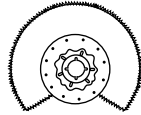

Cord Clean Wire Wheel



12Ton Crimper

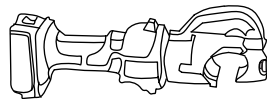

Bolt Breakers



M14 to 5/8"-11 adaptor  
(optional)



Straight Blade

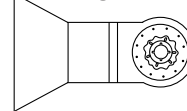

Wire Nippers

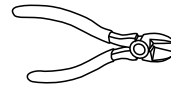

Quick Change Chuck

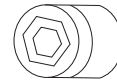

Setting Plate

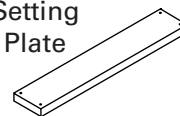

Deburr Flap Disc

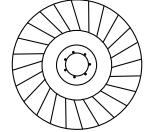

Pointed Blade

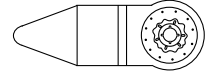

Hand Crimper



H100 Nut Driver



6 lb. Hammer

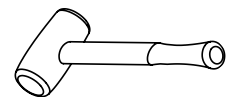

# Parts List

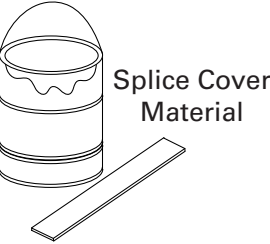
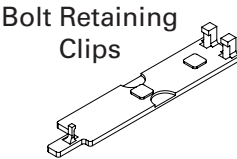
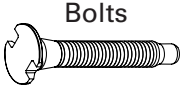
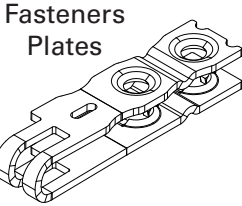
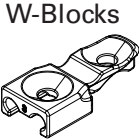
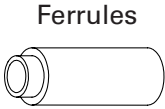

# General Safety Rules – Save These Instructions

---

## Signal words

---

“DANGER” indicates an imminently hazardous situation which, if not avoided, **will** result in death or serious injury. The signal word is limited to the most extreme situations.

“WARNING” indicates a potentially hazardous situation which, if not avoided, **could** result in death or serious injury.

“CAUTION” indicates a potentially hazardous situation which, if not avoided, **may** result in minor or moderate injury. It may also be used to alert against unsafe practices.

---

## International Safety Symbol

---



This international safety symbol is used to identify and call attention to specific safety matters.

---

## Safety Information

---

To Avoid Severe Personal Injury or Property Damage, read carefully and understand the following Safety Precautions.

### 1. WORK AREA SAFETY

#### **DANGER**

Never repair conveyors before applying OSHA Lock-Out/Tag-Out protocols, see 29 CFR 1910.147(a)(1) (i).

Do not allow bystander, visitor, or children in work area during tool operation.

#### **WARNING**

Store tools outside the reach of children and untrained persons. Tools are dangerous in the hands of unskilled users.

#### **CAUTION**

Keep work area clean and well lit. Clutter and dark areas invite accidents.

### 2. PERSONAL PROTECTIVE EQUIPMENT

#### **WARNING**

**EYE PROTECTION** which conforms to ANSI specifications and provides protection against flying particles both from the FRONT and SIDE should ALWAYS be worn by the operator and others in the work area. Eye protection is required to guard against flying debris, which could cause severe eye injury.

The employer and/or user must ensure that proper eye protection is worn. Eye protection equipment must conform to the requirements of the American National Standards Institute, ANSI Z87.1 and provide both frontal and side protection. NOTE: Non-side shielded spectacles and face shields alone do not provide adequate protection.

#### **CAUTION**

**HEARING PROTECTION** will be required in some environments. For example, the working area may include exposure to noise level which can lead to hearing damage. The employer and user must ensure that any necessary hearing protection is provided and used by the operator and others in the work area.

## General Safety Rules *(continued)*

### CAUTION

**HEAD PROTECTION** – Some environments will require the use of head protection equipment. When required, the employer and user must ensure that head protection conforming to ANSI Z89.1 is issued.

**FOOT PROTECTION** – Safety footwear should always be worn. Operators must be protected against falling tools, stepping on nails, and slippery conditions.

**HAND PROTECTION** – Safety gloves should always be worn against hot surfaces and other sharp objects.

### 3. PERSONAL SAFETY

#### WARNING

Do not use in explosive environments as this may result in serious personal injury.

Always handle tools with care: 1.) Never engage in horseplay; 2.) Keep others a safe distance from the tool while tool is in operation as accidental actuation may occur, possibly causing injury; 3.) Never place a hand or any part of body in the tools.

Do not operate the equipment if you are:

1.) Taking medication, feeling drowsy, feeling unwell or feeling tired; 2.) Under the influence of drugs or alcohol; 3.) Experiencing pain in hands, feet, lower back, or other parts of your body hurt or are injured. Failure to observe this precaution can result serious injury or even death.

When using tools to perform work-related activities, you may experience discomfort in the hands, arms, shoulders, neck, or other parts of the body: 1) Adopt a comfortable posture while maintaining secure footing and avoid awkward off-balanced postures; 2) Changing posture during extended tasks may help avoid discomfort and fatigue; 3) In case of persistent or recurring symptoms, consult a qualified health professional.

When lending someone the equipment, make sure the safety instructions have been thoroughly read and fully understood by the person who is going to use the equipment.

### 4. INITIAL EQUIPMENT STATUS

#### WARNING

Visually confirm there are no missing or broken components. If found, stop use and have the tool checked by a qualified technician. Check and ensure triggers are moving freely with no binding. Open and close latched head where applicable to assure proper function. Rotate head where applicable to ensure it rotates 180 degrees. If head rotates more than 180 degrees, stop use and have tool checked by a qualified technician. Please read the instructions supplied with the battery and charger.

At the end of operation, secure the tool to prevent unauthorized use. Never assume you will find the equipment in the same condition in which you left it.

#### CAUTION

Do not alter or modify tools from the original design or function without approval from FLEXCO.

Always be aware that misuse and improper handling of tools can cause injury to yourself and others.

### 5. MAINTENANCE SAFETY

#### CAUTION

**REPLACEMENT PARTS** – FLEXCO replacement parts are recommended. Do not use modified parts or parts which will not give equivalent performance to the original equipment.

# FXC™ Steel Cord Belt Fastening System

## ⚠ WARNING

Prior to any work on conveyors, be sure that the power has been turned off and the belt is “locked out.” Follow other safety precautions outlined in the operator’s manual.

## Belt Preparation

1

Square the belt using the centerline method and cut the belt as square as possible

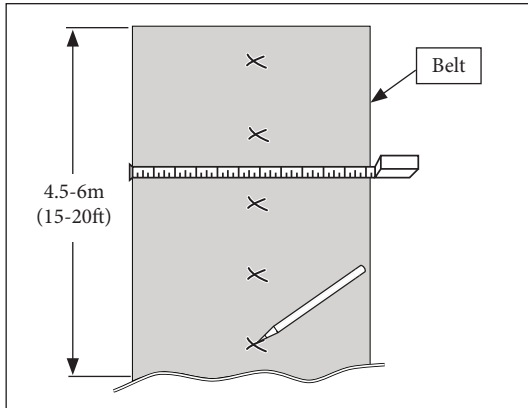

1-1

Mark the actual center points in belt width at intervals of 915-1525mm (3-5 feet) for a distance back from the intended splice area of 4.5-6m (15-20 feet).

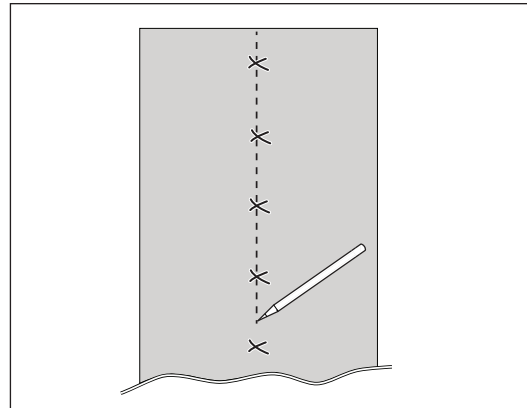

1-2

Cut belt at least 150mm (6 inches) behind old splice. Using either a straight edge or a chalk line, mark the average center line through the measured points.

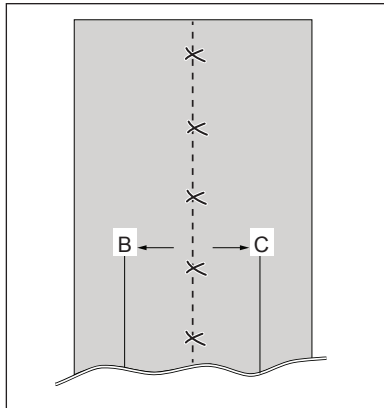

1-3

Mark two lines “B” and “C” equal distance from the center line in the area where you are going to install the splice, running parallel to the center line.

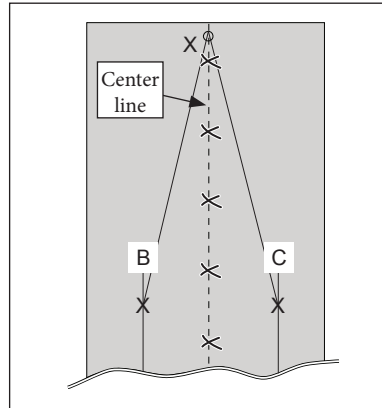

1-4

Measure back from the intended splice area a distance equal to approximately 3x the belt width and mark this point. Then measure equal distances to lines “B” and “C” at the intended splice area and mark these points.

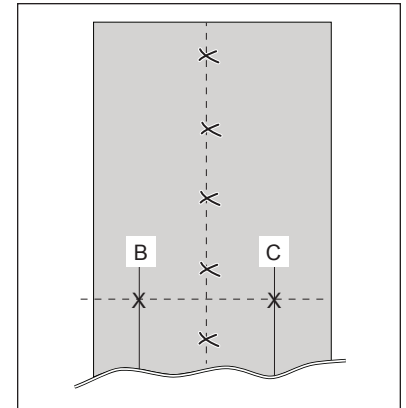

1-5

Align a straight edge or a chalk line through these points across full width of the belt. The resulting line is the true square.

1-6

Cut belt using end user preferred cutting method.

## Belt Preparation

2

### Buff the End of Belt and Cords

Buff the end of the belt to clean up frayed cords, using the deburr flap disc.



Debur Flap Disc

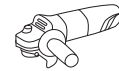

Angle Grinder

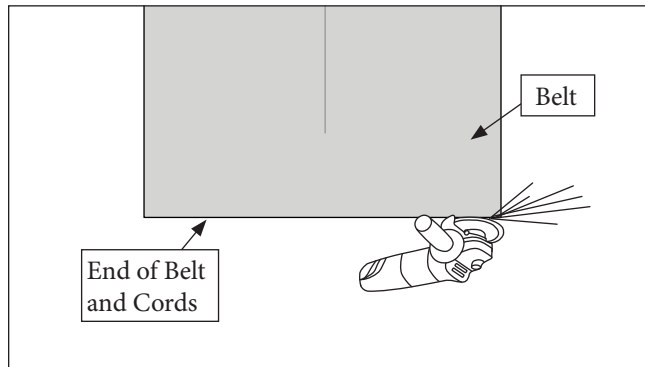

3

### Measure, Mark, and Score Rubber Covers

3-1

Using the centerline, mark four separate squared lines at the following intervals from the belt end.

**Note:** Locate the shortest area of the belt as the starting point for the measurements.

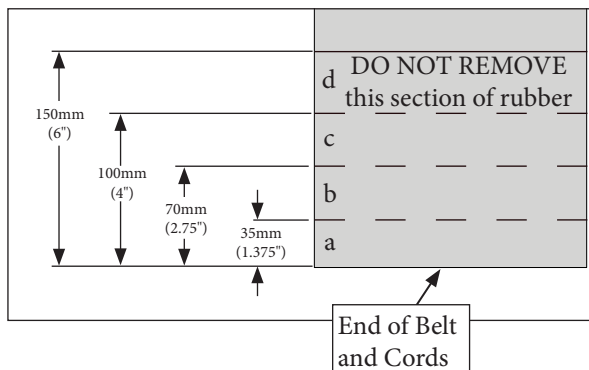

3-2

Score lines a, b and c with the round blade through the rubber cover to the cords. Make multiple passes through the rubber cover until contacting the cords. DO NOT score reference line "d".

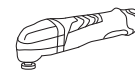

Oscillating Tool



Round Blade

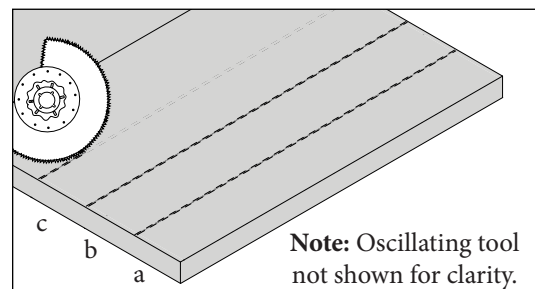

## Belt Preparation

4

Remove the Rubber Covers with Straight Blade

**CAUTION:** Do not start at the end of the belt for the first cut as this will damage the ends of the cords.

**Note:** It is recommended to place a flat surface beneath the belt to provide support.  
Maintain a proper blade angle and apply pressure against the cords while pushing the blade.  
Gradually work across the width of the belt using multiple partial passes for each section.  
Frequently sharpen blade to reduce cutting effort.



Oscillating Tool

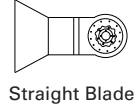

Straight Blade

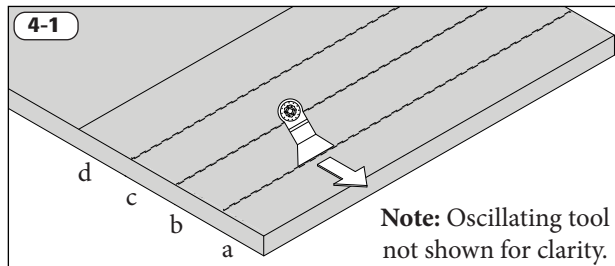

Working towards the end of the belt, first remove the rubber cover from section “a”.

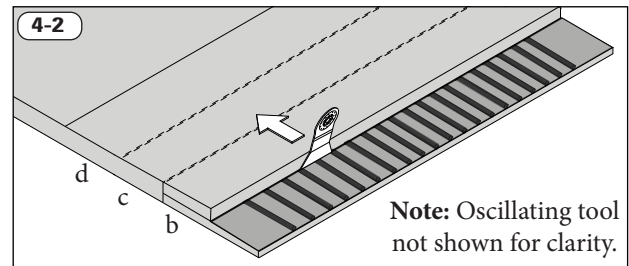

Next remove the rubber covers from sections “b” and “c” working towards the belt

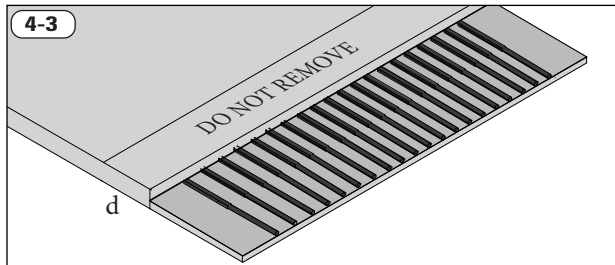

Do not remove rubber cover from section “d”.

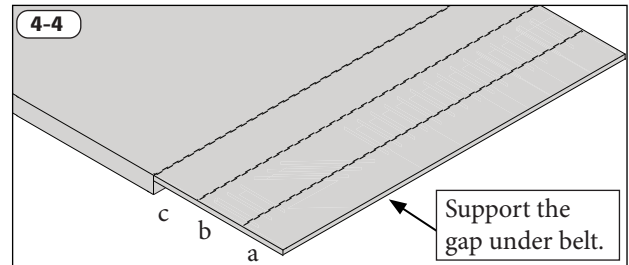

Flip the belt so the underside is now facing up. Transfer over the 100mm (4”) line at the end of section “c” then mark lines “a” and “b”. Repeat steps 4-1 and 4-2.

**Note:** It is recommended to place a flat surface under the belt gap to support the cords.



## Belt Preparation

5

### Remove Rubber Strips Between Cords with Pointed Blade

Clear work area under cords so blade can move unobstructed.

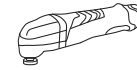

Oscillating Tool

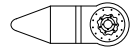

Pointed Blade

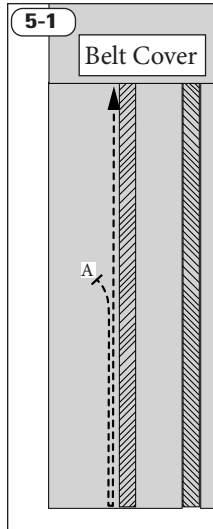

Plunge blade into location “A” and cut rubber along the length of the cord working towards the end of the cord first, then back towards the belt.

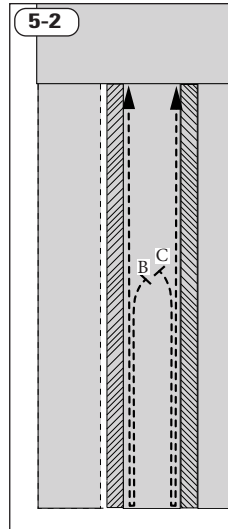

Plunge the blade to location “B” and cut rubber along the length of the cord working towards the end of the cord first, then back towards the belt. Plunge into location “C” along the length of the cord working towards the end of the cord first, then back towards the belt.

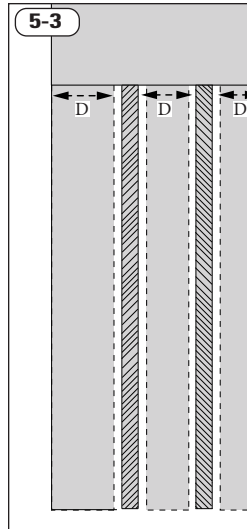

Plunge into location “D” and cut remaining rubber. Use caution when cutting into location “D” to avoid damaging the cords. Pull off any remaining rubber strips. Complete step 5-3 after completing steps 5-1 and 5-2 for all cords. This will increase blade life.

**CAUTION:** Always use flat backside of the blade against the cords.

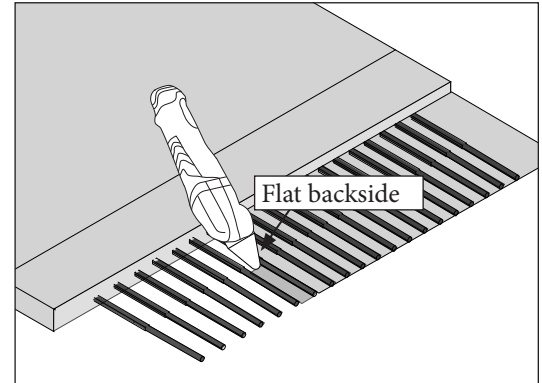

6

### Remove Remaining Rubber on Cords with Cord Clean Wire Wheel

6-1

Pressing firmly against the cords, use multiple passes until cords are shiny.

Note: You may leave a maximum of 13mm (1/2") of rubber at the point where the cords intersect the belt.

6-2

Flip the belt and repeat step 6-1 for the topside of the belt. Note: Test the W-Block and ferrules for proper fit before finishing.

**CAUTION:** Verify that rotation of wheel is facing free end of cords.



Angle Grinder



Cord Clean Wire Wheel

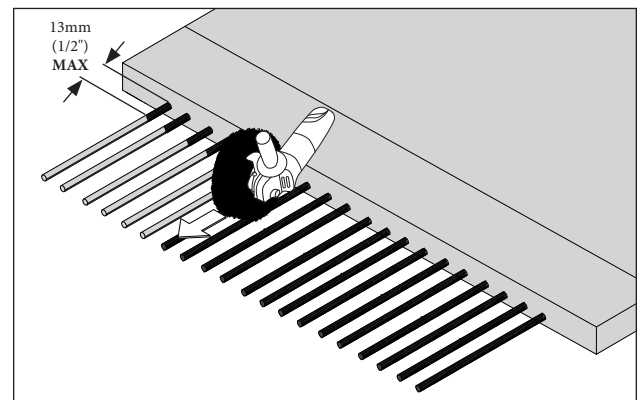

**NOTE:** It is recommended to place a flat surface under the cords.

## Splice Assembly

7

### Hand Crimp the Ferrules onto the Cords

When placing ferrules on the cords verify the small neck of the ferrule is facing the end of the cord. Use wire nippers to clean up any frayed cord ends.

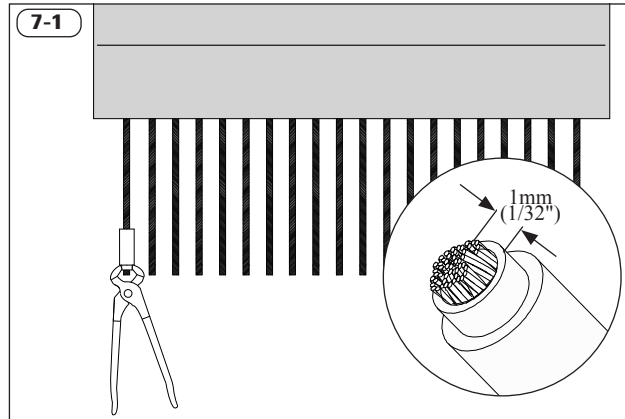

Find shortest cord and hand crimp the small neck of ferrule leaving 1mm (1/32") of exposed cord.



Hand Crimper

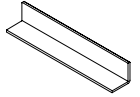

Straight Edge



Ferrules



Wire Nippers

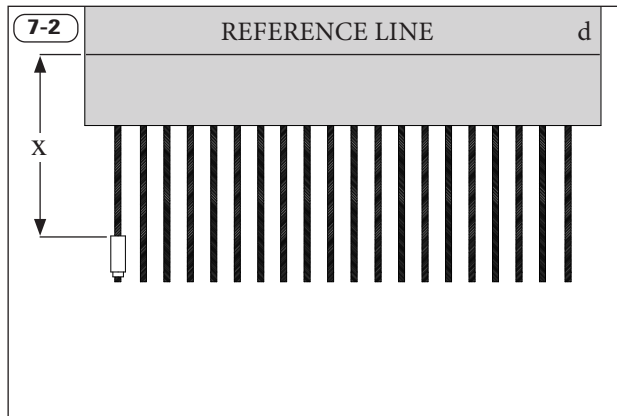

Measure distance (x) from reference line "d" to the non crimped end of the ferrule.

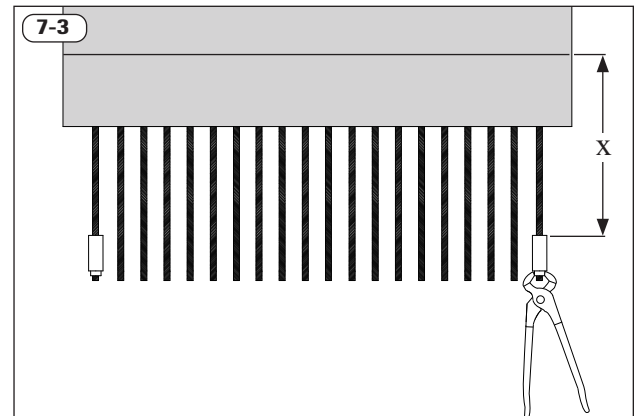

Hand crimp both end ferrules the same distance from the reference line used for the first ferrule in step 7-2.

# Splice Assembly

**REFER TO SPLICE DIAGRAM CARD FOR APPROVED SPLICE TYPE**

**FOR TEMPORARY SPLICE AND 100% BELT PULL**

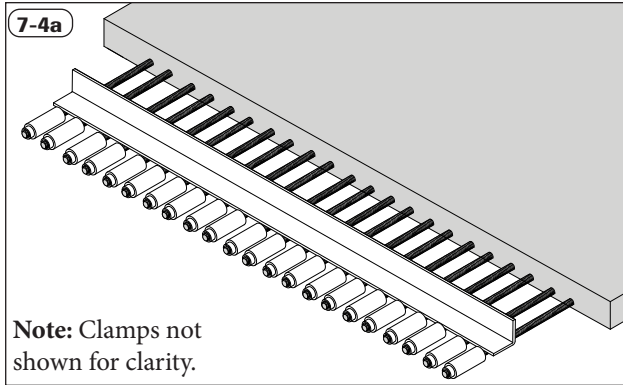

**Note:** Clamps not shown for clarity.

Clamp a straight edge into place using the two end ferrules as guides for the straight edge. Hand crimp all remaining ferrules into location using the straight edge to locate the ferrules. Skip to Step 8.

**CAUTION:** Verify all ferrules are secured.

**FOR 50% BELT PULL**

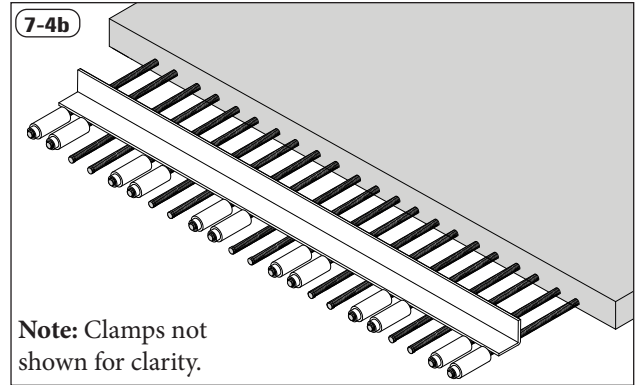

**Note:** Clamps not shown for clarity.

Clamp a straight edge into place using the two end ferrules as guides for the straight edge. Starting at both ends, hand crimp two ferrules then skip two cords. Continue towards the middle of the belt using the straight edge to locate the ferrules. Skip to Step 8.

**CAUTION:** Verify all ferrules are secured.

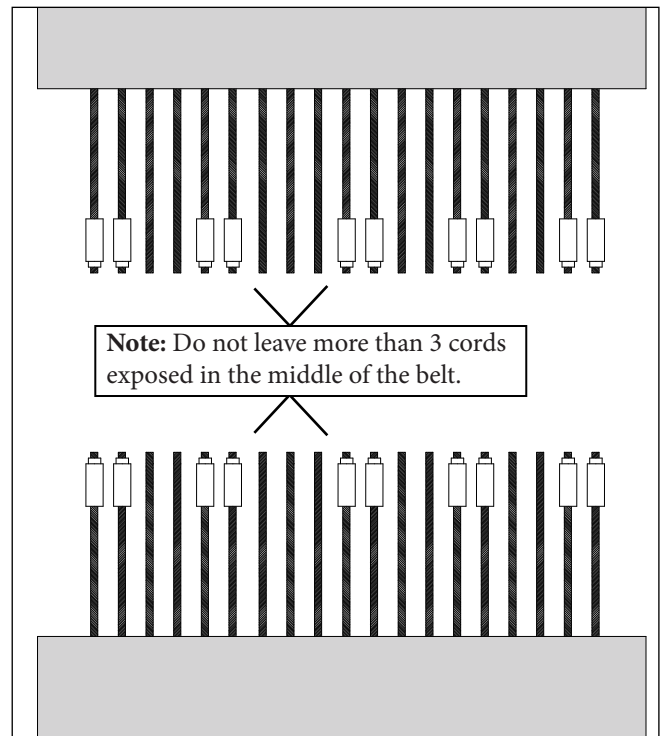

**Note:** Do not leave more than 3 cords exposed in the middle of the belt.

**CAUTION:** Verify ferrule placement matches opposite belt end.



## Splice Assembly

8

### Load Crimper Dies and Die Holders

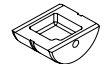
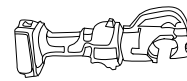

12Ton Crimper

Crimper Dies

Crimper Holder

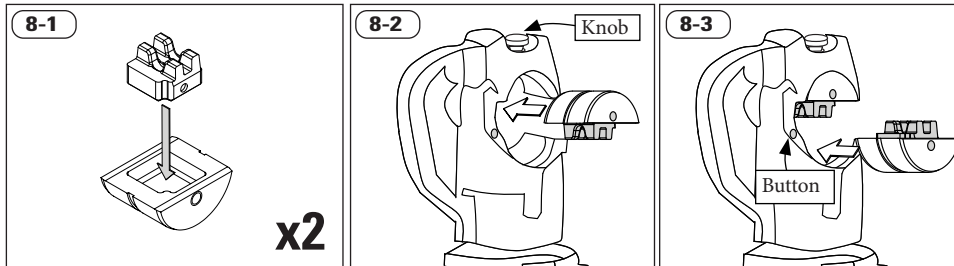

**8-1**  
Insert crimper dies and set screws into the die holders and tighten set screw with allen wrench provided.

x2

**8-2**  
Load top die holder into the crimper tool by pulling up on top die holder knob then release the knob to lock into place.

**8-3**  
Load bottom die holder into the crimper tool by pushing bottom die holder button then release the button to lock into place.

**CAUTION:** Ensure crimper dies are properly inserted into the tool. The set screws for the die holders should be aligned on the same side. Legs of the opposite dies should not crash or collide into each other. Keep fingers free of moving dies.

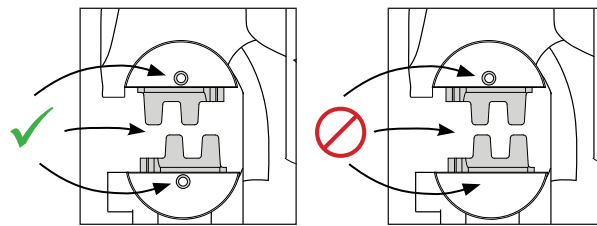

9

### Crimp Ferrules into Place Using the 12 Ton Crimper

**CAUTION:** Maximum 3mm (1/8") of the end of the cord should be exposed. Cut or grind excess cord so it doesn't interfere with splice and hinge pin assembly.

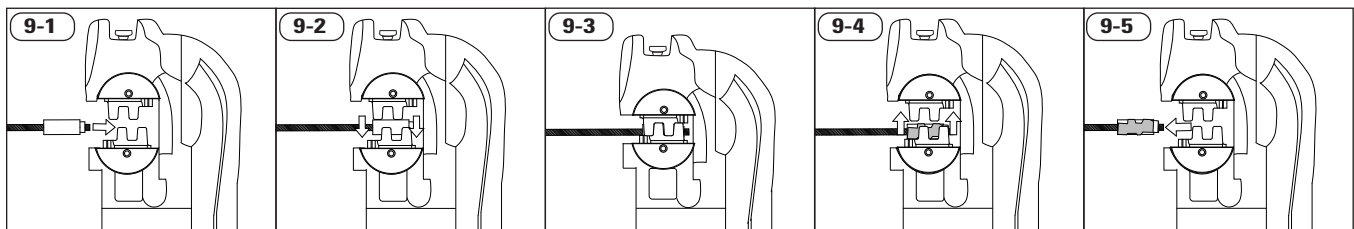

**9-1**  
Insert ferrule into the crimper dies. Verify ferrule is centered in the crimper dies.

**9-2**  
Repeatedly tap and release gray trigger to slowly close the tool. Do not close all the way on ferrule.

**9-3**  
Center the ferrule, then depress and hold the gray trigger. The crimper dies will close and once the cycle is complete, the tool will automatically shut off.

**9-4**  
Depress and hold the black trigger to move dies apart.

**9-5**  
Release the ferrule. Repeat steps 10-1 through 10-5 for all ferrules.

**NOTE:** For more detailed information see the Crimper Tool instruction manual.

## Splice Assembly

10

### Install W-Blocks

Start from each end of the belt working towards the middle. Place the W-Block over the cords ensuring the cords lock into the W-block. Make sure the square edge of the W-block contacts the ferrules.

**CAUTION:** Ensure the top side of the belt is facing up.

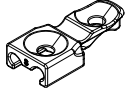

W-Blocks

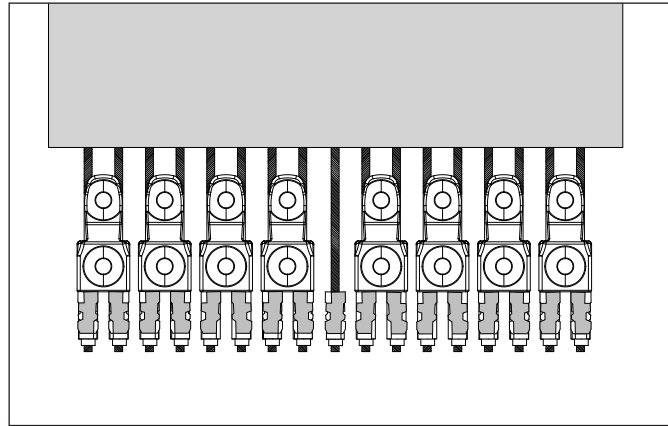
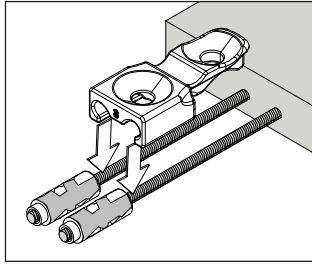

**NOTE:** Do not use center cords if there are an odd number of cords.

## Splice Assembly

11

### Install Fastener Plates, Bolts, Bolt Retaining Clips, and Nuts

Optional: Flip belt to the bottomside to install fastener plates, bolts, and bolt retaining clips. Flip belt to original position before installing nuts.

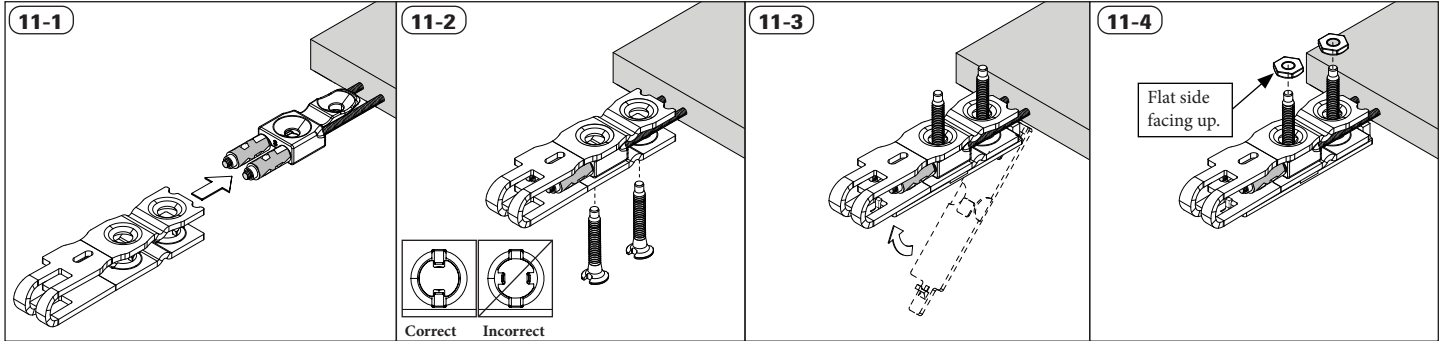
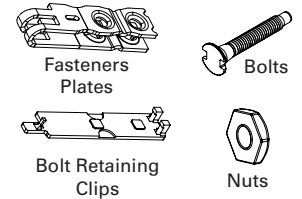

**11-1** Install the fasteners over the W-Blocks. Verify the holes with the tabs go on the bottom side of the belt.

**11-2** Insert bolts through the holes from the underside of the plate. Verify bolt slots align in fastener plate tabs.

**11-3** Hold bolts in place from above, then underneath install bolt retaining clips to secure the bolts into position in the fastener plates.

**11-4** Hand thread the nuts on the bolts to engage a couple threads. Ensure flat side of the nut is facing up.

12

### Tighten Nuts Down Against the Fastener Plates With the H100 Nut Driver

**CAUTION:** Do not overtighten as this will strip the threads or break the bolts.



Impact Driver  
1/2 (13mm)

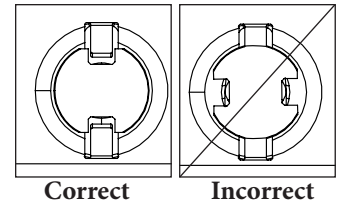

**CAUTION:** Verify bolt heads stayed aligned in fastener plate tabs.

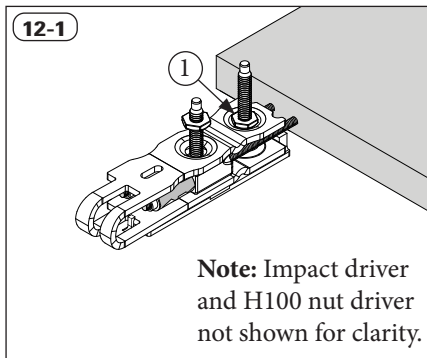

**Note:** Impact driver and H100 nut driver not shown for clarity.  
Tighten the nut closest to the edge of the fastener plate first.

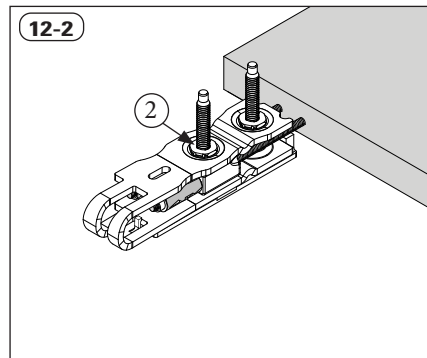

Tighten the nut closest to the loop last.

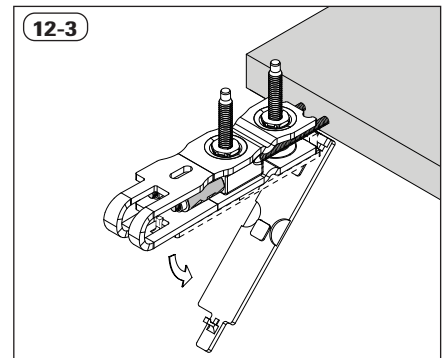

Remove bolt retaining clips from fastener plates by pushing on the tab.

## Splice Assembly

13

Grind or Break the Bolts, then Peen the Bolts

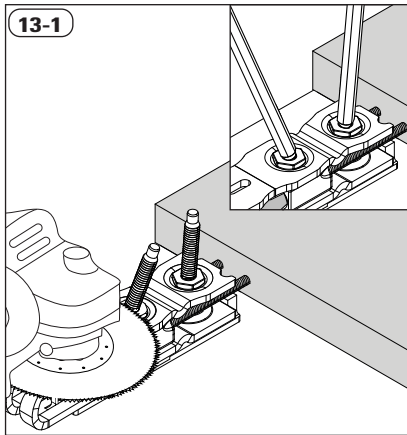
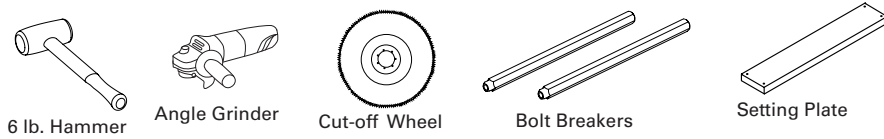

Use angle grinder with cut-off wheel or the bolt breakers to remove the excess bolt as flush to the nut as possible.

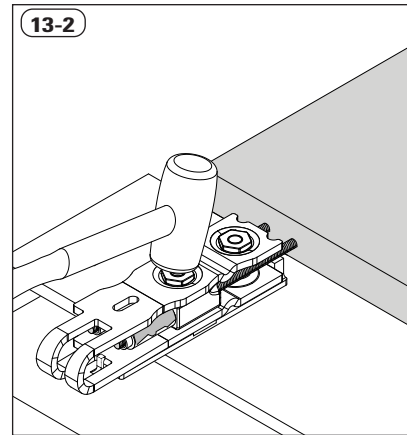

Peen bolts using 6 lb. hammer and setting plate or a hard surface under the fastener plates. Peening prevents the nuts from backing off.

**CAUTION:** Do not strike the fastener loop area when peening the bolts

# Splice Assembly

14

Join Belt Ends, Inset Hinge Pin

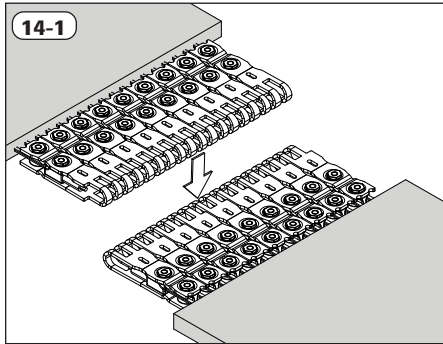

Overlap loops to join belt ends together. Fastener loops must be inserted down into the mating loops to join them.

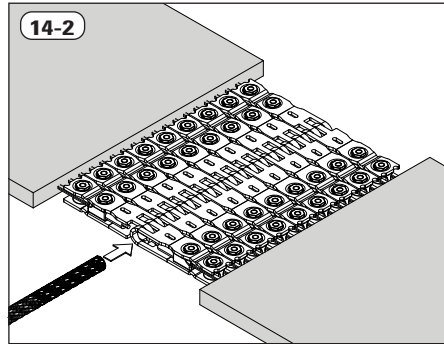

Insert hinge pin into loop area.

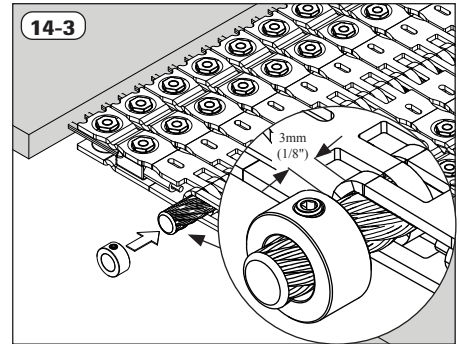

Install hinge pin retaining collars. Leave a minimum 3mm (1/8") gap from edge of fastener to edge of collar. Tighten set screw with allen wrench provided.

**CAUTION:** Verify plate alignment.

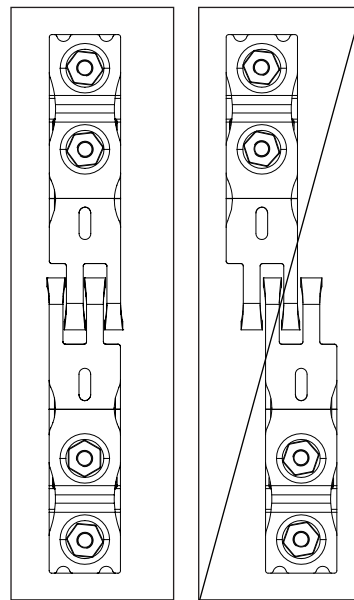

Correct

Incorrect

**Note:** If hinge pin is too long, use a hose clamp to contain the wires before cutting and rewelding. Remove after welding.

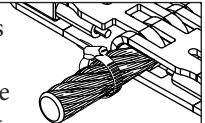



# FXC™ Steel Cord Belt Fastening System

## Splice Belt Cover

15

For Temporary Splice Only, Cover Splice with a Rubber Filler Material



Angle Grinder



Deburr Flap Disc



Cord Clean Wire Wheel

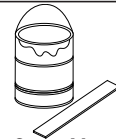

Splice Cover Material



Duct Tape

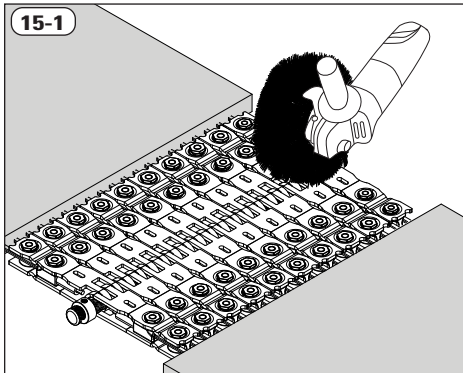

15-1

Use the cord clean wire wheel to roughen the fastener plates.

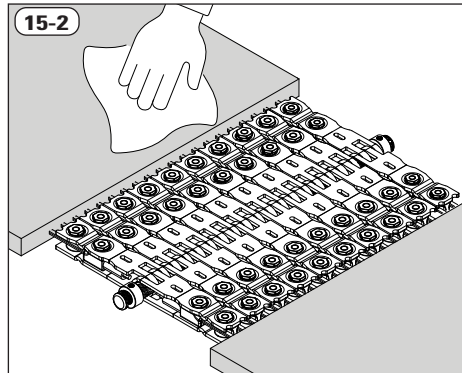

15-2

Clean fastener plates and surrounding the top cover with rubbing alcohol or manufacturers recommendation.

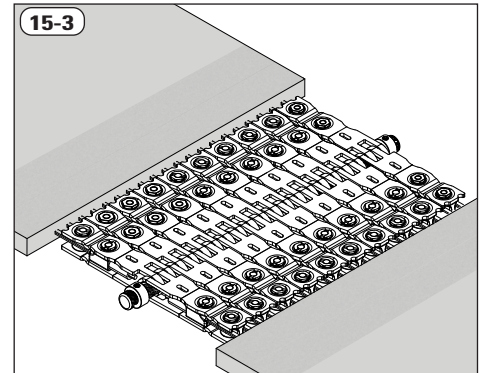

15-3

Use deburr flap disc to roughen surrounding the belt top cover. (Approx. 250mm (10")). Wipe away rubber debris from top cover and fastener plates.

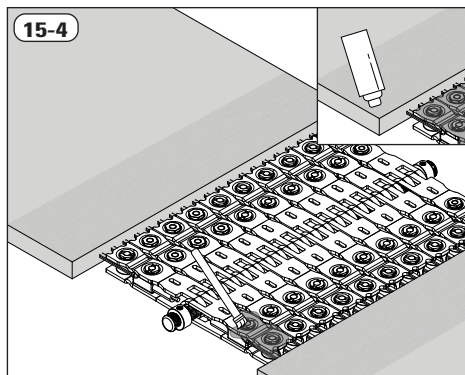

15-4

Apply metal primer to the fastener plates. Wait for the primer to become tacky to the touch of the latex gloves. Apply a second coat if needed. Then apply surface conditioner to belt top cover.

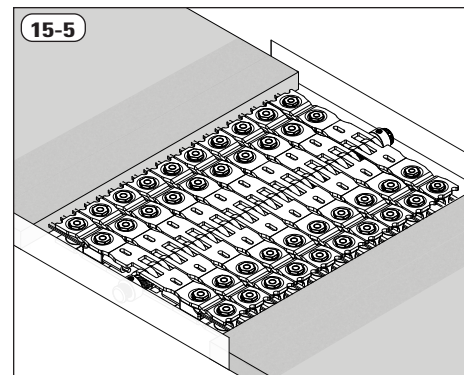

15-5

Use duct tape on sides and bottom to contain the filler material. Apply duct tape to the sides of the splice first to create a wall. Use a minimum of two layers of duct tape. Apply duct tape to the bottom of the splice, completely covering fastener plates and overlapping onto the bottom cover to create a water tight seal.

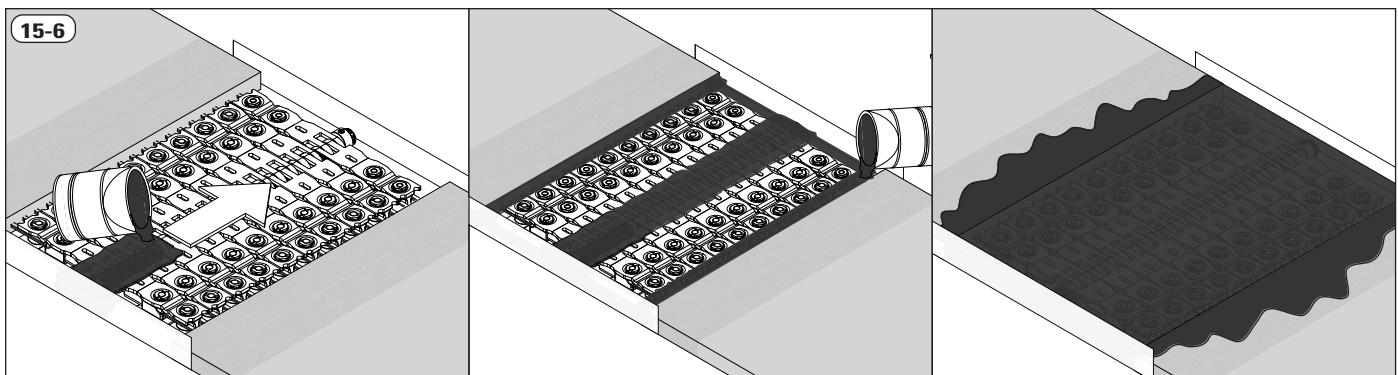

15-6

Mix and stir the cover resin and activator material, refer to manufacturer instructions. Slowly pour cover material to fill and cover the splice. First, start pouring in hinge pin location. Next, pour around the outer perimeter of the splice ensuring the exposed cords are completely filled and covered. Lastly, pour to cover and fill the fastener plates and remainder of splice area completely. Using the plastic spatula, spread evenly across the splice and feather onto the top cover.

Belt is ready to run in 60 - 90 minutes depending on rubber filler manufacturer instructions.







Visit [www.flexco.com](http://www.flexco.com) for other Flexco locations and products.

©2024 Flexible Steel Lacing Company. 05/07/24

