

Keeping your line

up and running

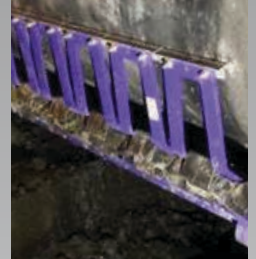

SINCE
1907

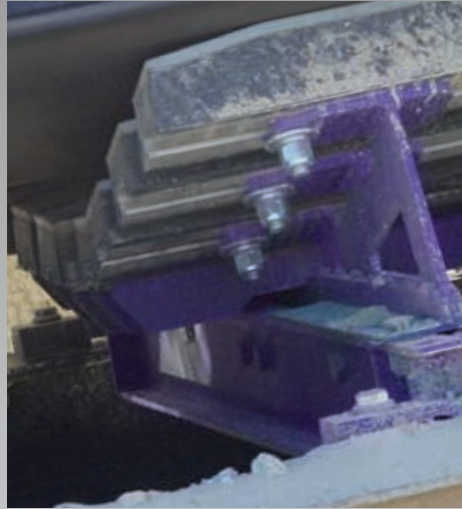
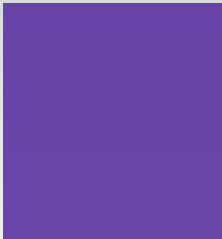

BELT CONVEYOR PRODUCTS

A comprehensive line of innovative belt conveyor products that address the key issues you face.

FLEXCO

Partners in Productivity

SOLUTIONS FOR EVERY ISSUE ALONG THE BELT LINE

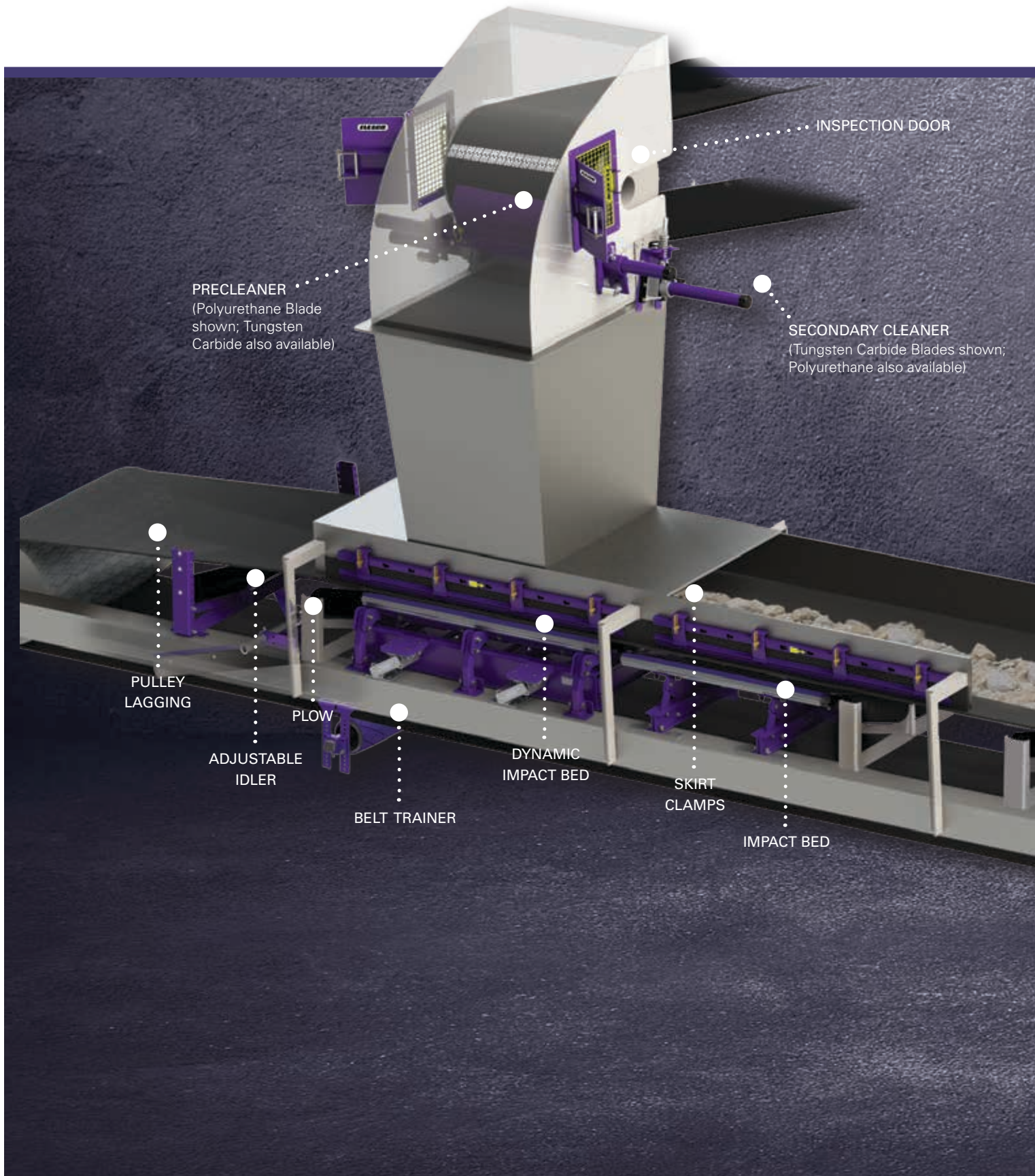

With over 100 years of experience in the belt conveyor industry, Flexco knows that keeping your line running smoothly is essential to the success of your operation. That's why we've developed a comprehensive line of innovative belt conveyor products that address the key issues you face.

Carryback

Material that sticks to the belt after it leaves the transfer point and continues falling off along the conveyor's return side. To address carryback, we offer:

- Belt Cleaners
- Belt Plows
- Cleaner Blades

Belt Slip

Occurs when the drive pulley is not adequately gripping the belt due to a loss of friction. To combat slippage, we offer:

- Ceramic Pulley Lagging
- Rubber Pulley Lagging

Mistracking

Belt drifts to one side or the other, resulting in material spillage, uneven belt wear, and possible system damage. To inhibit mistracking, we offer:

- Belt Trainers
- Belt Positioners

Spillage

Material that spills off the belt, typically at transfer and load points. To curb spillage, we offer:

- Skirt Clamps
- Impact Beds
- Belt Plows
- Urethane Skirting





Innovative Designs, Superior Engineering, Industry Expertise

Since 1907, we've been dedicated to improving belt performance and productivity. That's meant spending a lot of time in the field, working alongside customers and learning about their everyday challenges—first-hand.

We use that hard-won knowledge to design belt conveyor products that work better and last longer. In fact, we pioneered many of the advanced features that have since become industry standards.

Cleaner Innovations

- Patented, Faceted Blade Profile—These blades continually renew their edges, creating more efficient cleaning
- Better-Performing Tungsten Carbide Cleaner Blades—After years of testing and research, we've created blades that last longer and wear more evenly
- Heavy-Duty Spring Tensioning Systems—An important part of our cleaning systems, our tensioners enable easy visual inspection and maintain proper tension
- "Material Path" Cleaning—This unique option lets you match your cleaner width to your actual material path, reducing differential blade wear
- Larger Diameter Poles—Our poles are designed to resist the powerful twisting forces caused by continuous belt motion

Belt Tracking Innovations

- Pivot-and-Tilt technology—Special sensors detect belt wander, then guide the belt back to the correct path

Impact Bed Innovations

- Velocity Reduction Technology™ —An exclusive feature of our impact beds, this technology deadens impact energy for less rebound and material degradation
- Slide-Out Service™ —Designed for fast and safe complete bar change-outs

Lagging Innovations

- An 80%-Ceramic Solution—We were the first to market with this option
- Incredibly Fast Installation—Our weld-on lagging is 50% faster to install than other lagging products



Mineline® – When “standard” products just won’t do.

Flexco Mineline® products have been designed and engineered to work—day in and day out—in some of the toughest applications in the world. Regardless of the application, whether it be underground coal mining, port loading facilities, or other heavy tonnage applications that test the strength and durability of your conveyor system, Mineline is the answer. Customers have come to expect a Flexco cleaner, impact bed or tracker with the Mineline brand by its name to excel—even in situations where other products have failed. Next to Mineline endorsed products, you’ll find this mark:



Flexco Belt Conveyor Products Deliver Benefits for Your Belt—And Your Bottom Line



Budget Savings

- Flexco cleaners and other belt conveyor products increase the life of the belt by reducing wear from carryback, mistracking, and other issues. Given the cost of belting, being able to keep your belts longer can mean substantial savings.
- Our products also help reduce wear on other key conveyor components, like rollers, pulleys, splices, and more. That saves you even more money.
- By cutting down on carryback, spillage, and other belt problems, our products also reduce safety hazards. And as you know, accidents can be costly—in terms of lost productivity and possible fines.



Lower Maintenance Costs

- Because they reduce carryback and spillage, our belt conveyor products cut down on time-consuming cleanup.
- When your belt and other important conveyor components are protected from damage, you can spend less time making repairs and less money buying replacement components. In fact, studies show that reducing carryback from 3 percent to 1 percent can result in a 67 percent reduction in maintenance costs.



Consistent, Efficient Performance

- Unscheduled shutdowns for maintenance or repairs mean serious production losses. Our belt conveyor products help you maximize uptime by correcting the issues—such as mistracking and carryback—that typically cause system damage.



Greater Safety

- Studies show that approximately 42 percent of conveyor-related accidents occur during maintenance activities. Our cleaners and other belt conveyor products minimize the need for maintenance and reduce the risk of accidents.



Serviceability

- Proper servicing of products, such as belt cleaners and impact beds, is key to ensuring effective and long-lasting performance. That’s why all Flexco products are designed with features that make regular servicing easy.
- We are continually enhancing our already service-friendly products, making them even easier to maintain. For example, we’ve added an easy-to-replace blade cartridge to our MHS Heavy-Duty Secondary Cleaner, and Slide-Out Service™ bars to our DRX™ Impact Beds.

YOUR ISSUE: CARRYBACK OUR SOLUTION: ADVANCED CLEANING SYSTEMS

Step 1 Understand Your Options

BELT CLEANERS

Precleaners

- Mounted to the head pulley and below the material flow
- Ideal for removing large pieces of material—typically about 60–70 percent of initial carryback
- Blade width/material path options

Secondary cleaners

- Located just past where the belt leaves the head pulley—and anywhere else down the beltline
- Especially good at removing fines, increasing cleaning efficiency to 90+ percent

BLADE OPTIONS

Polyurethane

- Easier on the belt
- Works well with mechanical splices
- Economical
- Specialty formulations for high heat, chemical resistance, or water removal



Tungsten carbide:

- Superior cleaning efficiency
- Long wear



Step 2 10 Key Criteria for Analyzing Your Conveyor System

- 1 Your belt speed and belt width*
 - 2 What types of splices are present and their condition*
 - 3 Any unusual characteristics of your load or environment (extreme heat, abrasiveness, mud, etc.)—a specialty cleaner that can withstand these conditions may be necessary*
 - 4 Whether the belt reverses
 - 5 Your conveyor structure width
 - 6 Your pulley diameter—typically, the larger the pulley, the larger the required cleaner
 - 7 Your pulley condition—if the pulley is worn or not perfectly round, a segmented blade may clean more effectively
 - 8 Where you plan to position the cleaner and how much room there is to accommodate it
 - 9 The material's path on the belt—matching the cleaner to the material path reduces differential blade wear
 - 10 Your desired level of performance and upkeep
- * **Note:** CEMA has created an application classification guide that addresses these three criteria. Further explanation of this is found on Page 7.

Step 3 Determine Whether You Need a Complete Solution

Some operators want their belts as clean as possible; others are comfortable with a certain amount of renegade material.

To achieve maximum cleaning efficiency, it's best to

bring together a precleaner and one or more secondary cleaners to form a comprehensive system. If you only want to install a single cleaner, try to target the area—such as the head pulley—where it will have the greatest effect.



APPLICATION CLASSIFICATION GUIDE



CEMA (Conveyor Equipment Manufacturers Association) publishes a guide with the explicit goal of providing "a uniform method for determining the application class of any individual belt cleaner." This is meant as a way to assist in the selection of the correct belt cleaner or belt cleaner system. The complete guide, titled "**Classification of Applications for Bulk Material Conveyor Belt Cleaning,**" or CEMA Standard 576, is available from CEMA.

The classification is built on a points system based on five key criteria. While others play a role as noted on Page 6, these five were chosen as the key elements in selecting the appropriate cleaner or cleaning system. The five criteria are:

1. **belt width**
2. **belt speed**
3. **splice type**
4. **material abrasiveness**
5. **material stickiness/moisture content**

Each of these criteria score points; points increase based on the impact it would have on the required cleaner. Wider belt widths, faster belt speeds, introduction of mechanical splices, increase in material abrasiveness (using CEMA Standard 550), and increasing the moisture content of the material all add to the point totals when scoring an application.

The results of scoring the application created five classes:

Score	Class
<6	1
7-10	2
11-15	3
16-23	4
>24	5

In accordance with this classification, you will find class ratings for Flexco's belt cleaners throughout this guide as another resource to assist you in choosing the correct cleaning system for your application, while keeping in mind the full criteria found on Page 6. For more detailed info on each cleaner, log on to www.flexco.com.

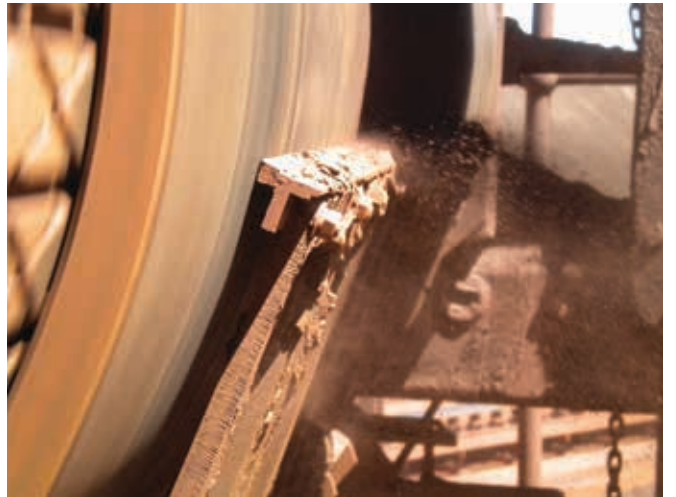

Shown: H-Type V-Tip Precleaner



Shown: MHS HD Secondary Cleaner



Shown: MDWS Secondary Cleaner



FLEXCO PRECLEANERS

FEATURES & APPLICATIONS

EZP-LS "Limited Space" Precleaners

- Compact design with shorter pole length
- Do-it-yourself installation and minimal maintenance
- Standard-duty, solid-blade design
- Visual tension check

EZP-LS Standard



Specifications:

Maximum Belt Speed*: 2.5 m/s (500 fpm)

Pulley Diameter: 150–550 mm (6"–22")

Applications: Brick/Block Plants, Ready Mix Plants, Road/Mobile Equipment

CEMA Class 2 ●●●

EZP-LS High-Temp

●●●●



- High-Temp Blade rated up to 135° C (275° F)
- Can handle temperature spikes to 163° C (325° F)
- Applications: Coke, Clinker, Cement, Asphalt

EZP-LS Stainless Steel Food Grade

●●●●



STAINLESS STEEL

- White food-grade, chemical-resistant ConShear™ blade
- Stainless Steel components for superior corrosion resistance
- Applications: Fermentation Byproducts, Preprocessed Foods

EZP1 Precleaners

- Standard-duty, with 60 mm (2 3/8") diameter pole
- Requires just 100 mm (4") of horizontal clearance
- Do-it-yourself installation and minimal maintenance
- Visual tension check

EZP1 Standard



Specifications:

Maximum Belt Speed*: 3.5 m/s (700 fpm)

Pulley Diameter: 250–900 mm (10"–36")

Applications: Aggregate, Sand & Gravel, Cement, Wood Processing, Recycling

CEMA Class 3 ●●●●

EZP1 High-Temp

●●●●



- High-Temp Blade rated up to 135° C (275° F)
- Can handle temperature spikes to 163° C (325° F)
- Applications: Coke, Clinker, Cement, Asphalt

EZP1 Ultra High-Temp

●●●●

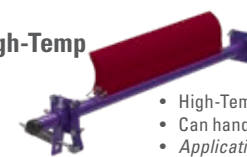

- High-Temp Blade rated up to 200° C (400° F)
- Can handle temperature spikes to 232° C (450° F)
- Applications: Coke, Clinker, Cement, Asphalt

EZP1 Stainless Steel Food Grade

●●●●



STAINLESS STEEL

- White food-grade, chemical-resistant ConShear™ blade
- Stainless Steel components for superior corrosion resistance
- Applications: Fermentation Byproducts, Preprocessed Foods

EZP1 Twist Tensioner

●●



- Compact Torsion Twist Tensioner allows for measurable and verifiable tension
- Tensioner compatible to mount on either end of pole

*Belt speeds can be higher in vulcanized applications.

MSP Standard Mine-Duty Precleaner

- Standard Mine-Duty, with 73 mm (2 7/8") diameter rugged pole design
- Do-it-yourself installation and minimal maintenance
- Mine-duty, solid blade design
- Highly effective cleaning
- Visual tension check

MSP Standard



Specifications:

Maximum Belt Speed*: 3.5 m/s (700 fpm)

Pulley Diameter: 400–1050 mm (16"–42")

Applications: Aggregate, Sand & Gravel, Cement, Wood Processing, Recycling

CEMA Class 3 ●●●

MSP Ultra High-Temp

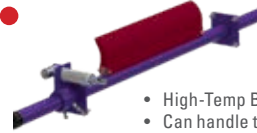

- High-Temp Blade rated up to 200° C (400° F)
- Can handle temperature spikes to 232° C (450° F)
- Applications: Coke, Clinker, Cement, Asphalt

MSP Stainless Steel



- Stainless Steel components for superior corrosion resistance
- Applications: Phosphate, Potash, Salt

MMP Medium Mine-Duty Precleaner

- Medium-duty mining precleaner with TuffShear™ blade
- Heavy-duty, 3-piece design pole with dual tensioners
- Visual tension check

MMP Standard



Optional PAT Tensioner

Specifications:

Maximum Belt Speed*: 5.0 m/s (1,000 fpm)

Pulley Diameter: 400–1200 mm (16"–48")

Applications: Underground Mining, Hard Rock Mining, Steel Mills, Iron Ore, Metal Mining, Aggregate, Coal-Fired Power Plants, Load-out Facilities

CEMA Class 4 ●●●●

MMP Stainless Steel



- Stainless Steel components for superior corrosion resistance
- Applications: Phosphate, Potash, Copper/Gold Mining, Salt, Load-out Facilities Near Salt Water

MHP Heavy-Duty Precleaner

- Heavy-duty, solid blade precleaner
- Heavy-duty, 3-piece design pole with rugged, dual spring tensioners
- Abrasion-resistant, XL solid polyurethane MegaShear™ blade



Optional PAT Tensioner

Specifications:

Maximum Belt Speed*: 7.5 m/s (1,500 fpm)

Pulley Diameter: 500–2100 mm (20"–84")

Applications: Underground Mining, Hard Rock Mining, Metal Mining, Longwall Coal Mining, Steel Mills, Iron Ore

CEMA Class 5 ●●●●●

MHCP Heavy-Duty Cartridge Precleaner

- One of the most rugged precleaners available
- Engineered for abusive conditions
- Telescoping 3-piece pole that resists twisting/bowing/bending
- Quick-change SuperShear™ blade cartridge for fast, easy maintenance



Optional PAT Tensioner

Specifications:

Maximum Belt Speed*: 6.0 m/s (1,200 fpm)

Pulley Diameter: 500–1200 mm (20"–48")

Applications: Underground Mining, Hard Rock Mining, Metal Mining, Longwall Coal Mining, Steel Mills, Iron Ore

CEMA Class 5 ●●●●●

*Belt speeds can be higher in vulcanized applications.

To learn more about Flexco precleaners, visit www.flexco.com.

HV2 Precleaner

- Tungsten carbide tip provides superior cleaning efficiency (vulcanized belts only)
- 150 mm (6") segmented blades work independently
- Adjustable cushions allow for enhanced pulley conformance
- Visual tension check



Specifications:

Maximum Belt Speed*: 7.5 m/s (1,500 fpm)

Pulley Diameter: 250–1675 mm (10"–67")

Applications: Power Plants, Port Facilities, Hard Rock Mining, Steel Mills, Iron Ore

CEMA Class 4 ●●●●

H-Type® HV/HVP Precleaner

- Tungsten carbide tip provides superior cleaning efficiency (vulcanized belts only)
- Segmented blades work independently
- Visual tension check



Specifications:

Maximum Belt Speed*: 7.5 m/s (1,500 fpm)

Pulley Diameter: 250–1575 mm (10"–63")

Applications: Power Plants, Port Facilities, Hard Rock Mining, Steel Mills, Iron Ore

CEMA Class 4 ●●●●

Optional HV Protected Tips

H-Type® High-Temp HV Precleaner

- Tungsten carbide tip provides superior cleaning efficiency (vulcanized belts only)
- Segmented blades work independently
- Adjustable cushions allow for enhanced pulley conformance
- Visual tension check

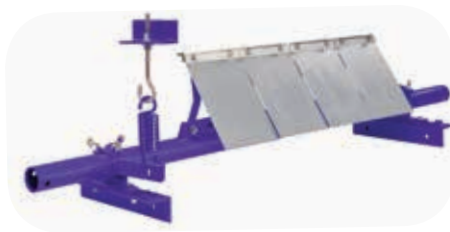

Specifications:

Maximum Belt Speed*: 5.0 m/s (1,000 fpm)

Pulley Diameter: 250–1575 mm (10"–63")

Applications: Power Plants, Port Facilities, Steel Mills, Iron Ore

CEMA Class 3 ●●●●

H-Type® HXF2 Precleaner

- Suitable as a stand-alone cleaner in standard and medium-duty applications
- Available with polyurethane



Specifications:

Maximum Belt Speed*: 5.0 m/s (1,000 fpm)

Pulley Diameter: 250–1325 mm (10"–53")

Applications: Underground Mining, Hard Rock Mining, Metal Mining, Aggregate

CEMA Class 4 ●●●●

*Belt speeds can be higher in vulcanized applications.

Applications listed are intended to identify where each cleaner is commonly and most effectively utilized. Belt conditions, belt speeds, and pulley diameters should all be considered before making a final product selection. Consult Flexco to assess specific applications and recommendations.

MXP Extreme-Duty Precleaner

- Flexco's largest, most rugged precleaner takes on the harshest mining applications
- 150mm and 300mm (6" and 12") blade segments are easily configured to match material path
- Robust 178 mm (7") diameter pole ends telescope into 203 mm (8") center pole and bolt in place
- Dual spring tensioners allow tension to be visually inspected



Specifications:

Maximum Belt Speed*: 10.0 m/s (2,000 fpm)

Pulley Diameter: 1200–2400 mm (48"–96")

Applications: Underground Mining, Hard Rock Mining, Metal Mining, Aggregate

CEMA Class 5 ●●●●●

**Belt speeds can be higher in vulcanized applications.*

Applications listed are intended to identify where each cleaner is commonly and most effectively utilized. Belt conditions, belt speeds, and pulley diameters should all be considered before making a final product selection. Consult Flexco to assess specific applications and recommendations.

PAT Portable Air Tensioner

- PAT ensures constant tension for full blade life with little maintenance
- Works with Flexco mechanical fasteners
- Usable with air, nitrogen or water
- Offers single or dual tank (for two cleaners) when site air is not available
- Featured on Mineline®-approved cleaners like MMP, MHP, MHCP, MHS and MDWS
- Can be configured as specials on many other cleaners

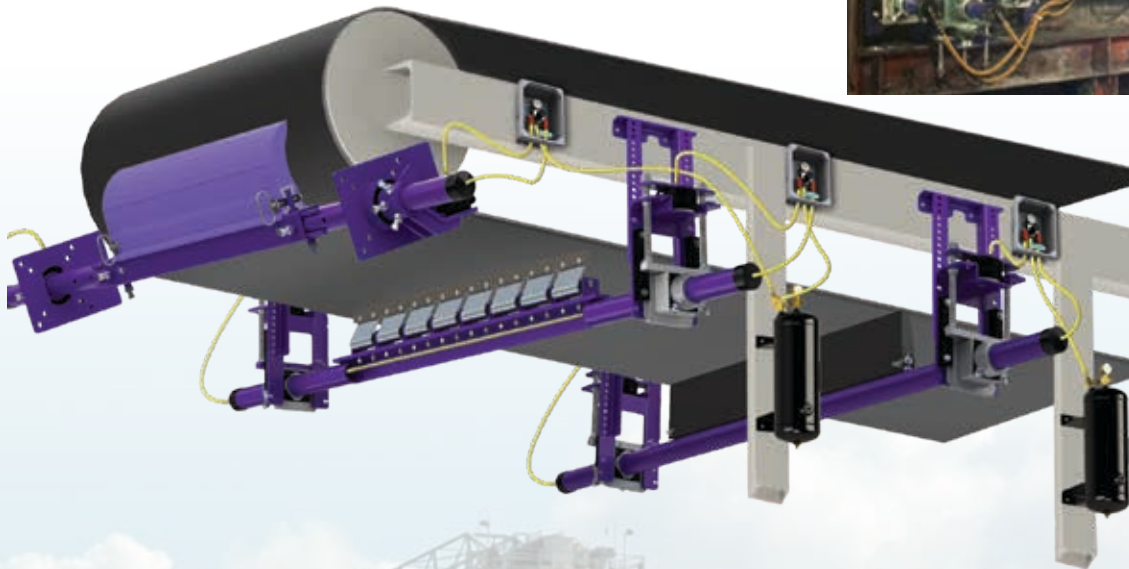
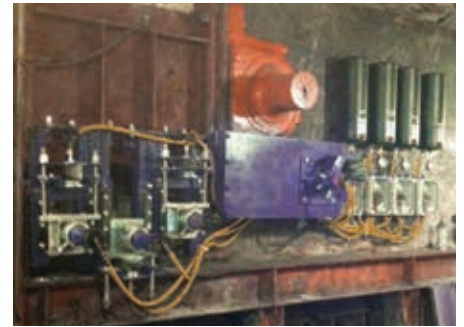



FLEXCO SECONDARY CLEANERS

FEATURES & APPLICATIONS

Y-Type Secondary Cleaner—Polyurethane

- Standard duty (belt widths 450-1200mm (18'-48"))
- Segmented tips easily serviced utilizing a removable cartridge
- Spring tensioned to deliver optimal cleaning performance and blade life
- Food grade/chemical resistant polyurethane option available
- Compatible with reversing belts

Y-Type SD Purple Blade

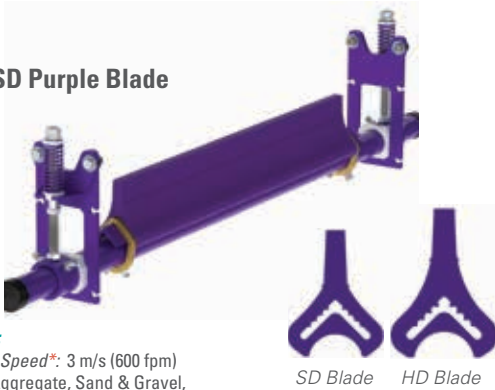

Specifications:

Maximum Belt Speed*: 3 m/s (600 fpm)
Applications: Aggregate, Sand & Gravel, Cement

CEMA Class 2 ●●

Y-Type SD White Blade



- Standard duty (belt widths 450-1200mm (18'-48"))
- Maximum belt speed: 3 m/s (600 fpm)
- Applications: Preprocessed Foods

CEMA Class 2 ●●

Y-Type HD Purple Blade



- Heavy duty (belt widths 900-1800mm (36"-72"))
- Maximum belt speed: 3.75 m/s (750 fpm)
- Applications: Aggregate, Sand & Gravel, Cement

CEMA Class 3 ●●

Y-Type HD White Blade



- Heavy duty (belt widths 900-1800mm (36"-72"))
- Maximum belt speed: 3.75 m/s (750 fpm)
- Applications: Preprocessed Foods

CEMA Class 3 ●●

Y-Type Secondary Cleaner—Tungsten Carbide

- Standard duty (belt widths 450-1200mm (18'-48"))
- Segmented tungsten carbide blades compatible with mechanical fastener applications are easily serviced utilizing a removable cartridge
- Spring tensioned to deliver optimal cleaning performance and blade life
- Compatible with reversing belts

Y-Type SD Tungsten Carbide Blade

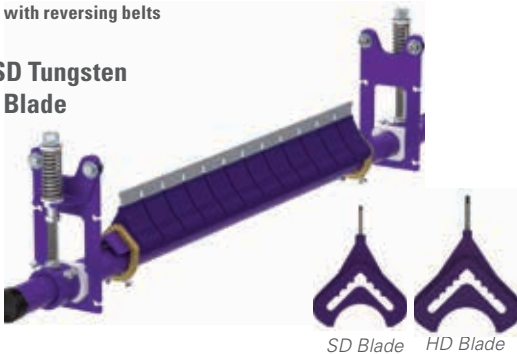

Specifications:

Maximum Belt Speed*: 3 m/s (600 fpm)
Applications: Aggregate, Sand & Gravel, Cement, Light Mining

CEMA Class 3 ●●

Y-Type HD Tungsten Carbide Blade



- Heavy duty (belt widths 900-1800mm (36"-72"))
- Maximum belt speed: 3.75 m/s (750 fpm)
- Applications: Aggregate, Sand & Gravel, Cement, Mining

CEMA Class 3 ●●

*Belt speeds can be higher in vulcanized applications.

EZS2 Secondary Cleaner

- Do-it-yourself installation
- Segmented tungsten carbide blades
- Patented FormFlex™ cushions that maintain optimal belt contact
- Bolt-up tensioning system



Specifications:

Maximum Belt Speed*: 3.5 m/s (700 fpm)

Applications: Aggregate, Sand & Gravel, Cement

CEMA Class 3 ● ●

High-Temp EZS2



- Temperature range up to 205°C (400°F)
- Applications: Cement, Asphalt



P-Type® Secondary Cleaner

- Available with C-Tips for mechanical fastener applications or V-Tips for vulcanized applications
- Segmented tungsten carbide blades
- Limited Space model option for telescoping, stacking, or portable conveyors
- Bolt-up tensioning system

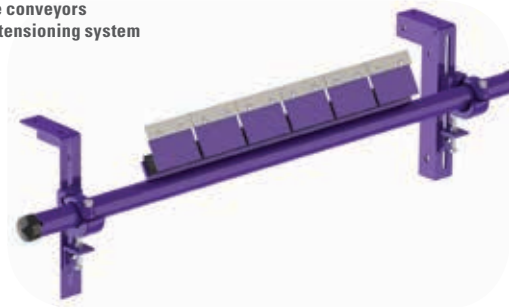

Specifications:

Maximum Belt Speed*: C-Tip: 5.0 m/s (1000 fpm)
V-Tip: 6.0 m/s (1200 fpm)

Applications: Aggregate, Sand & Gravel, Cement, Wood Processing, Light Mining, Power Plants with Vulcanized Belts

CEMA Class 4 ● ●

P-Type® Cartridge Secondary Cleaner

- Available with C-Tips for mechanical fastener applications or V-Tips for vulcanized applications
- Service Advantage Cartridge feature allows for easy service and inspection
- Bolt-up tensioning system



Specifications:

Maximum Belt Speed*: C-Tip: 5.0 m/s (1000 fpm)
V-Tip: 6.0 m/s (1200 fpm)

Applications: Aggregate, Sand & Gravel, Cement, Wood Processing, Light Mining, Power Plants with Vulcanized Belts

CEMA Class 4 ● ●

R-Type® Reversing Secondary Cleaner

- Available with C-Tips for mechanical fastener applications or V-Tips for vulcanized applications
- Two-way cushions that accommodate reversing belts
- Do-it-yourself installation
- Bolt-up tensioning system



Specifications:

Maximum Belt Speed*: C-Tip: 5.0 m/s (1000 fpm)
V-Tip: 6.0 m/s (1200 fpm)

Applications: Aggregate, Sand & Gravel, Cement, Wood Processing, Light Mining, Recycling, Power Plants with Vulcanized Belts

CEMA Class 4 ● ●

R-Type® Cartridge Secondary Cleaner

- Available with C-Tips for mechanical fastener applications or V-Tips for vulcanized applications
- Two-way cushions that accommodate reversing belts
- Service Advantage Cartridge feature allows for easy service and inspection
- Bolt-up tensioning system



Specifications:

Maximum Belt Speed*: C-Tip: 5.0 m/s (1000 fpm)
V-Tip: 6.0 m/s (1200 fpm)

Applications: Aggregate, Sand & Gravel, Cement, Wood Processing, Light Mining, Ideal for Power Plants with Vulcanized Belts

CEMA Class 4 ● ●

*Belt speeds can be higher in vulcanized applications.

FLEXCO SECONDARY CLEANERS *Continued*

FMS Medium-Duty Secondary

- Available with C-Tips for mechanical fastener applications or V-Tips for vulcanized applications
- Cleaning efficiency of segmented tungsten carbide blades
- Compact MST spring tensioning system



Specifications:

Maximum Belt Speed*: C-Tip: 5.0 m/s (1000 fpm)
V-Tip: 6.0 m/s (1200 fpm)

Applications: Underground Mining, Hard Rock Mining, Metal Mining, Aggregate, Load-out Facilities, Iron Ore, Steel Mills, Power Plants

CEMA Class 4 ●●●●

MHS Heavy-Duty Cartridge Secondary

- Segmented blades with choices of tungsten carbide tips
- Patented PowerFlex™ cushions maintain optimal belt contact
- Tensioners and cushion create 4 points of relief, making the cleaner fastener-friendly
- Service Advantage Cartridge™ feature allows for easy service and inspection



Specifications:

Maximum Belt Speed*: C-Tip: 6.0 m/s (1200 fpm)
V-Tip: 7.5 m/s (1500 fpm)

Applications: Underground Mining, Hard Rock Mining, Metal Mining, Aggregate, Load-out Facilities, Iron Ore, Steel Mills, Power Plants

CEMA Class 5 ●●●●●

MHS Heavy-Duty Secondary

- Segmented blades with choices of tungsten carbide tips
- Patented PowerFlex™ cushions maintain optimal belt contact
- Tensioners and cushion create 4 points of relief, making the cleaner fastener-friendly
- Two-way cushions available for reversing applications that roll back, or tripper and stacker applications



Specifications:

Maximum Belt Speed*: C-Tip: 6.0 m/s (1200 fpm)
V-Tip: 7.5 m/s (1500 fpm)

Applications: Underground Mining, Hard Rock Mining, Metal Mining, Aggregate, Load-out Facilities, Iron Ore, Steel Mills, Power Plants

CEMA Class 5 ●●●●●

Optional SAT2 Tensioner

Optional MST Tensioner (reduces belt speed max)

MHS SS Secondary

●●●●●



STAINLESS STEEL

- Stainless Steel components for superior corrosion resistance
- Applications: Salt, Copper/Gold Mining, Phosphate, Potash, Load-out Facilities

U-Type® Secondary

- U-shaped blade and offset pole that intensify cleaning power
- Blade tips that scrape off stubborn carryback, while rubber backers "squeegee" wet material
- Best for cupped belts and belts with worn centers
- Choice of tungsten carbide, impact-resistant tungsten carbide, or polyurethane blade tips
- Blade replacement made easy with removable front plate
- Works best in wet applications



Specifications:

Maximum Belt Speed*: C-Tip: 1300 fpm (6.6 m/s)

Applications: Cement, Coal Mining, Coal Prep Plants, Power Plants, Load-out Facilities

CEMA Class 5 ●●

U-Type® SS Secondary

●●●●●



STAINLESS STEEL

- Stainless Steel components for superior corrosion resistance
- Applications: Power Plants, Load-out Facilities

Applications listed are intended to identify where each cleaner is commonly and most effectively utilized. Belt conditions, belt speeds, and pulley diameters should all be considered before making a final product selection. Consult Flexco to assess specific applications and recommendations.

Chevron Secondary Cleaner

- For raised top, chevron, or grooved belts
- Hundreds of rubber fingers that flick off carryback
- Free-rotating design that works only when the belt runs
- Do-it-yourself installation and quick drum replacement



Specifications:

Maximum Belt Speed*: 2.5 m/s (500 fpm)

Applications: Wood Chipping, Sand

CEMA Class 3 ●

Motorized Brush Cleaner

- Uniquely patterned bristles aid in reducing material buildup and clogging
- Adjustable tensioners allow easy brush-to-belt adjustment as the bristles wear
- Spins opposite the belt direction for optimal cleaning
- Do-it-yourself installation and quick drum replacement



Specifications:

Maximum Belt Speed*: 3.5 m/s (700 fpm)

Applications: Wood Chipping, Sand

CEMA Class 4 ●

MDWS DryWipe Secondary

- Removes excess water to ensure a dry return trip down the belt line
- Ideal for systems using a water spray pole
- Do-it-yourself installation and minimal maintenance



Specifications:

Maximum Belt Speed*: 5.0 m/s (1000 fpm)

Applications: Underground Mining

CEMA Class 4 ●

Optional SAT2 Tensioner

Wash Box

- Fully enclosed to clean belt and then contain the waste wash water
- Configurable cleaner mounting plate accepts all of Flexco's superior secondary belt cleaners
- Hinged doors on each side for easy service and inspection
- Hold-down roller provides proper tension for each cleaner
- Available for belts 600-1500 mm (24"-60") in galvanized or stainless steel

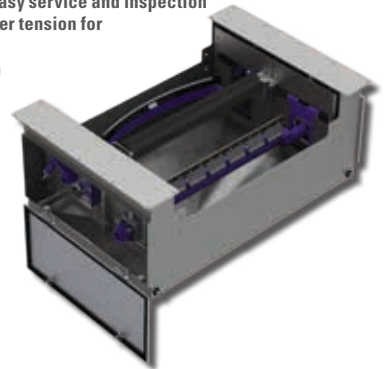

FLEXCO CLEANERS AND FASTENERS: BETTER, TOGETHER

Many of our cleaning systems have special features that allow them to interface seamlessly with our mechanical belt fasteners.

Shown: MHS Secondary Cleaner with Service Advantage Cartridge™

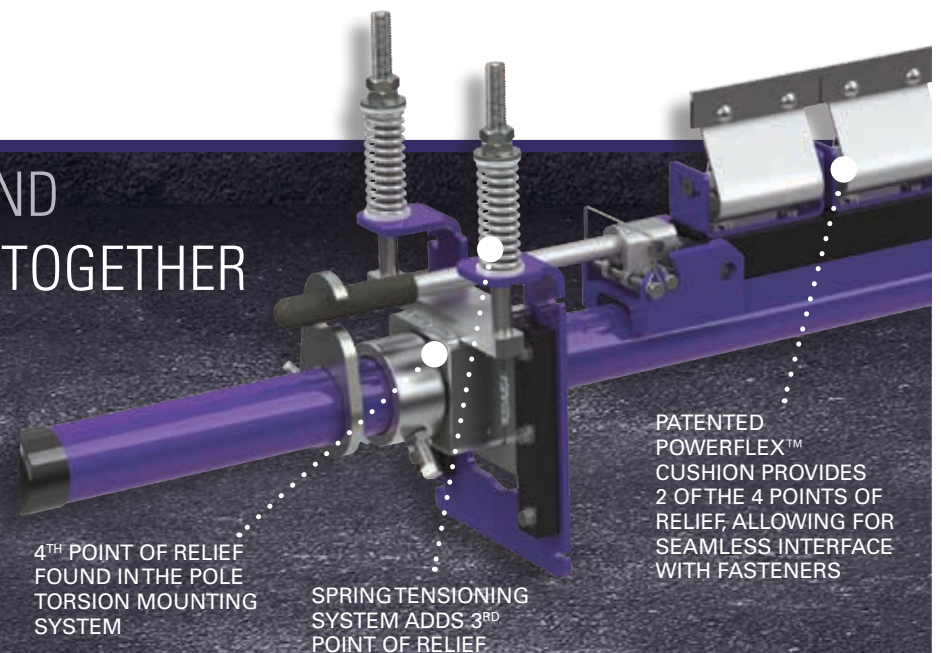

4TH POINT OF RELIEF FOUND IN THE POLE TORSION MOUNTING SYSTEM

SPRING TENSIONING SYSTEM ADDS 3RD POINT OF RELIEF

PATENTED POWERFLEX™ CUSHION PROVIDES 2 OF THE 4 POINTS OF RELIEF, ALLOWING FOR SEAMLESS INTERFACE WITH FASTENERS

BLADE AND CLEANER OPTIONS

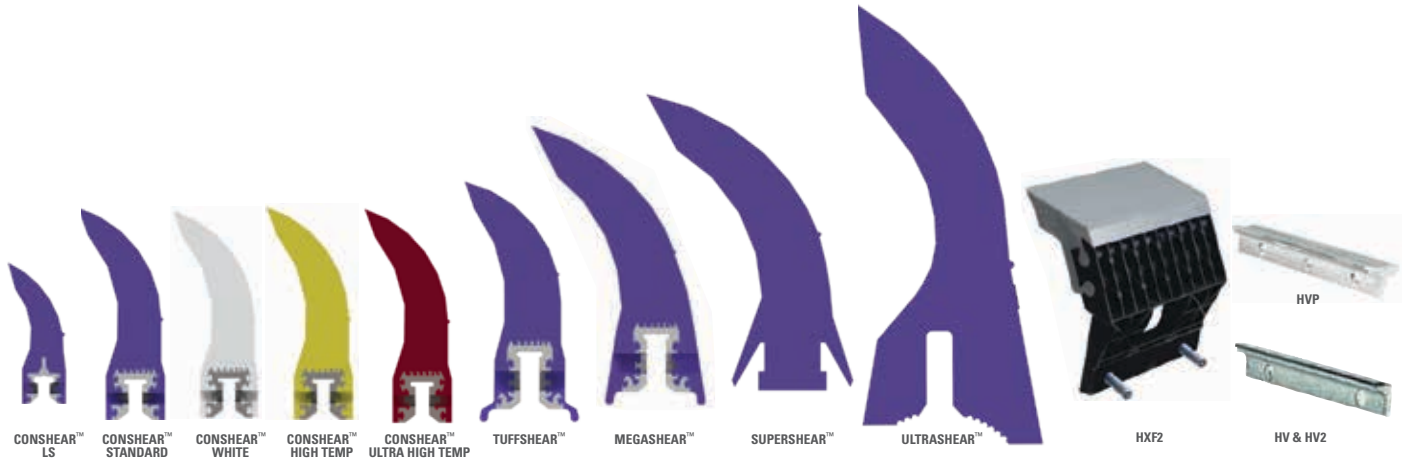

Precleaner Options

Application Description	EZP-LS	EZP1 (Std/White)	EZP1 High Temp	EZP1 UHT	MSP	MSP UHT	MMP	MHP	MHCP	MXP	H-Type® (XF2 & XF)	H-Type® (HV & HV2)	High Temp V-Tip
Belt Width*	300–1500mm 12"–60"	300–1800mm 12"–72"	300–1800mm 12"–72"	300–1800mm 12"–72"	600–2100mm 24"–84"	600–1800mm 24"–72"	600–2400mm 24"–96"	600–2400mm 24"–96"	600–2400mm 24"–96"	1050–3000mm 42"–120"	450–1800mm 18"–72"	450–1800mm 18"–72"	450–1200mm 18"–48"
Belt Speed**	< 2.5 m/s 500 fpm	< 3.5 m/s 700 fpm	< 3.5 m/s 700 fpm	< 3.5 m/s 700 fpm	< 3.5 m/s 700 fpm	< 3.5 m/s 700 fpm	< 5.0 m/s 1000 fpm	< 7.5 m/s 1500 fpm	< 1200 fpm 6.0 m/s	< 10.0 m/s 2000 fpm	< 5.0 m/s 1000 fpm	< 7.5 m/s 1500 fpm	< 5.0 m/s 1000 fpm
Head Pulley Diameter	150–550mm 6"–22"	250–900mm 10"–36"	250–900mm 10"–36"	250–900mm 10"–36"	400–1050mm 16"–42"	400–1050mm 16"–42"	400–1200mm 16"–48"	500–2100mm 20"–84"	500–1200mm 20"–48"	1200–2400mm 48"–96"	250–1175mm 10"–47"	250–1675mm 10"–67"	200–875mm 8"–35"
Temperature Range	-35 to 82°C -30 to 180°F	-35 to 82°C -30 to 180°F	< 135°C (275°F) with spikes to 163°C (325°F)	< 200°C (400°F) with spikes to 232°C (450°F)	-35 to 82°C -30 to 180°F	< 200°C (400°F) with spikes to 232°C (450°F)	-35 to 82°C -30 to 180°F	-35 to 82°C -30 to 180°F	-35 to 82°C -30 to 180°F	-35 to 135°C -30 to 275°F	-35 to 82°C -30 to 180°F	-35 to 82°C -30 to 180°F	< 200°C (400°F) with spikes to 232°C (450°F)
Blade	ConShear LS	ConShear	ConShear	ConShear	ConShear	ConShear	TuffShear	MegaShear	SuperShear	UltraShear	HXF, HXF2	HV	HV
Reversing Belts	Yes	Yes	Yes	Yes	Yes	Yes	Yes	Yes	Yes	Yes	Yes	Yes	Yes
Mechanical Fasteners	Yes	Yes	Yes	Yes	Yes	Yes	Yes	Yes	Yes	Yes	Yes	No	No

*Special sizes available upon request.

**Belt speeds can be higher in vulcanized applications.



Secondary Cleaner Options

Application Description	Y-Type SD Polyurethane	Y-Type HD Polyurethane	Y-Type SD Carbide	Y-Type HD Carbide	EZS2 (C-Tip)	EZS2 High Temp	P-Type (C-Tip)	P-Type (V-Tip)	P-Type LS (C-Tip)	R-Type® (C-Tip)	R-Type (V-Tip)
Belt Width*	450 – 1200 mm 18" – 48"	900 – 1800 mm 36" – 72"	450 – 1200 mm 18" – 48"	900 – 1800 mm 36" – 72"	450 – 1800 mm 18" – 72"	450 – 1800 mm 18" – 72"	450 – 1800 mm 18" – 72"	450 – 1800 mm 18" – 72"	450 – 1350 mm 18" – 54"	450 – 1800 mm 18" – 72"	450 – 1800 mm 18" – 72"
Belt Speed**	< 3.0 m/s 600 fpm	< 3.8 m/s 750 fpm	< 3.0 m/s 600 fpm	< 3.8 m/s 750 fpm	< 3.5 m/s 700 fpm	< 3.5 m/s 700 fpm	< 5.0 m/s 1000 fpm	< 6.0 m/s 1200 fpm	< 5.0 m/s 1000 fpm	< 5.0 m/s 1000 fpm	< 6.0 m/s 1200 fpm
Temperature Range	-35 to 82°C -30 to 180°F	-35 to 82°C -30 to 180°F	-35 to 82°C -30 to 180°F	-35 to 82°C -30 to 180°F	-35 to 92°C -30 to 200°F	up to 200°C (400°F) with spikes to 232°C (450°F)	-35 to 82°C -30 to 180°F	-35 to 82°C -30 to 180°F	-35 to 82°C -30 to 180°F	-35 to 82°C -30 to 180°F	-35 to 82°C -30 to 180°F
Reversing Belts	Yes	Yes	Yes	Yes	No	No	No	No	No	Yes	Yes
Work with Mechanical Fasteners	Yes	Yes	Yes	Yes	Yes	Yes	Yes	No	Yes	Yes	No

Application Description	FMS (C-Tip)	FMS (V-Tip)	MHS (C-Tip)	MHS (V-Tip)	U-Type® (F-Blade)	U-Type (C-Blade)	MDWS	Chevron	Motorized Brush Cleaner
Belt Width*	450 – 2100 mm 18" – 84"	450 – 2100 mm 18" – 84"	450 – 2400 mm 18" – 96"	450 – 2400 mm 18" – 96"	450 – 2100 mm 18" – 84"	450 – 2100 mm 18" – 84"	450 – 1800 mm 18" – 72"	450 – 2100 mm 18" – 84"	450 – 2100 mm 18" – 84"
Belt Speed**	< 5.0 m/s 1000 fpm	< 6.0 m/s 1200 fpm	< 6.0 m/s 1200 fpm	< 7.5 m/s 1500 fpm	< 5.0 m/s 1000 fpm	< 6.6 m/s 1300 fpm	< 8.1 m/s 1600 fpm	< 2.5 m/s 500 fpm	< 3.5 m/s 700 fpm
Temperature Range	-35 to 82°C -30 to 180°F	-35 to 82°C -30 to 180°F	-35 to 82°C -30 to 180°F	-35 to 82°C -30 to 180°F	-35 to 82°C -30 to 180°F	-35 to 82°C -30 to 180°F	-35 to 82°C -30 to 180°F	-35 to 82°C -30 to 180°F	-30 to 82°C -20 to 180°
Reversing Belts	No	No	Yes	Yes	No	No	No	Yes	No
Work with Mechanical Fasteners	Yes	No	Yes	No	Yes	Yes	Yes	Yes	Yes

*Special sizes available upon request.

**Belt speeds can be higher in vulcanized applications.

FLEXCO BELT CLEANER ACCESSORIES



Mounting Plate Kit

- incl. 2 plates, 400 x 800 mm (16" x 32")
- For use with Mounting Bars to mount cleaners on open head pulleys
- For use with MSP, MMP, MHP, MHCP



Optional Mounting Bar Kit

- incl. 8 bolts, nuts and washers
- For mounting precleaners on open head pulleys
- Weld on both sides of pulley and bolt on steel plates
- For use with MSP, MMP, MHP, MHCP



Optional Top Angle Kit

- Used with both Standard and Long SST Mounting Bracket Kits (below left) for additional mounting options



SST Mounting Bracket Kit

- For MHS or MDWS secondary cleaner installs requiring additional mounting versatility
- Long mounting bracket kit also available for installations that require extra length legs



MST Mounting Bracket Kit

- For FMS secondary cleaner installs requiring additional mounting versatility



YST Mounting Bracket Kit

- For Y-Type secondary cleaner installs requiring additional mounting versatility



Inspection Door

- Lockable design
- Dust-tight seal
- Available in 300 x 300mm, 300 x 450mm, 450 x 600mm, and 600 x 600mm (12"x12", 12"x18", 18"x24", and 24"x24")
- Available with or without screen



Stabilizing Rollers

- For use in applications with belt cup or belt flap
- By preventing these issues secondary cleaner performance and blade/tip life is enhanced



Water Spray Pole Kit

- Stainless steel pole with powder coated steel clamp brackets
- For use with secondary cleaners for an exceptionally clean belt
- Typical pressure setting is 276-414 kPa (40-60 psi)



Spring Covers and Tensioner Locks (for Precleaners and Secondaries)

- Spring Covers protect spring and threaded rod from contamination and material buildup
- Tensioner Lock prevents unauthorized cleaner retensioning

YOUR ISSUE: BELT MISTRACKING OUR SOLUTION: BELT TRAINERS

To select the right belt trainer, you need to consider whether:

- The belt is wandering to one or both sides
- The top or return side of the belt is affected
- The mistracking is happening consistently or occasionally
- The belt has a low, medium or high running tension

Use the following chart to identify the best Flexco belt trainer for your needs.

Conveyor Criteria	Belt Positioner™	PTEZ™	PT Smart™	PT Max™	PT Max™ Heavy Duty	PT Max™ Super Duty
Top side mistracking	No	No	No	Yes	Yes	Yes
Return side mistracking	Yes	Yes	Yes	Yes	Yes	Yes
Reversing belts	Yes	Yes	No	No	No	No
Belt mistracking to one side	Better	Better	Better	Better	Better	Better
Belt mistracking to both sides	Acceptable	Better	Best	Best	Best	Best
Inconsistent tracking problem	Good	Better	Best	Best	Best	Best
Belt is cupped (heavy)	Best ‡	Better ‡	Better	Better	Better	Better
Belt has edge damage	Best	Best	Good	Good	Good	Good
Ease of installation	Best	Better	Good	Good	Good	Good
Belt has low running tension	Good	Good	Good	Good	N/A	N/A
Belt has medium running tension	Better	Better	Better	Best	Best	Best
Belt has high running tension	N/A	N/A	N/A	Better	Best	Best
Approx. "upstream" effect*	15 M (50')	6 M (20')	6 M (20')	15 M (50')	15 M (50')	15 M (50')
Approx. "downstream" effect*	15 M (50')	30 – 36 M 100' – 120'	36 – 45 M 120' – 150'	45 – 61 M 150' – 200'	45 – 61 M 150' – 200'	45 – 61 M 150' – 200'

‡ Installed on clean side of return belt

* Typical results; actual results may vary

FLEXCO BELT TRAINERS

FEATURES & APPLICATIONS

Belt Positioner™

- Simple solution for belts wandering to a single side
- Fixed, angled rollers "funnel" the belt onto the correct path
- Return-side installation only
- Easy to install and maintain
- Available with steel or rubber-lagged rollers



Specifications:

Maximum Belt Tension: Small, Medium and Large: 157.5 n/mm (900 PIW)
Extra-Large: 210 n/mm (1200 PIW)

Belt Dimensions: From 450–2400 mm (18–96") wide

PTEZ™

- Tapered roller ends drive “pivot and tilt” mechanism to correct mistracking
- Versatile mounting options. Can be installed on clean side of return belt if belt is cupped
- Polyurethane roller cover to ensure long-lasting performance
- Easy to install on one-way and reversing belts



Specifications:

Maximum Belt Tension: 1600 PIW
Belt Widths: 450-1200 mm (18-48")



Specifications:

Maximum Belt Tension: 2400 PIW
Belt Widths: 1050-2100 mm (42-84")

- Stainless Steel components for superior corrosion resistance

PT Smart™

- Sensor rollers detect wander, then “pivot and tilt” belt into place
- Economical solution for medium-tension belts
- Effectively prevents belt from damaging structure
- Easy to install
- Specially designed to fit underground conveyors



Specifications:

Maximum Belt Tension: 280 n/mm (1600 PIW)
Belt Widths: 450-1800 mm (18-72")

PT Max™ Top Side

- Sensor rollers detect wander, then “pivot and tilt” belt into place
- Ideal solution for cupped and high-tension belts
- Performs in wet and dry conditions
- Top-side installation only



Specifications:

Maximum Belt Tension: 525 n/mm (3000 PIW)
Belt Widths: 600-1500 mm (24-60")

Heavy Duty PT Max™ Top Side

- Ideal for high tension belts

Specifications:

Maximum Belt Tension: 1050 n/mm (6000 PIW)
Belt Widths: 1350-2100 mm (54"-84")

Super Duty PT Max™ Top Side

- For highest tension applications

Specifications:

Maximum Belt Tension: 1750 n/mm (10,000 PIW)
Belt Widths: 1800-3000 mm (72"-120")

PT Max™ Return Side

- Sensor rollers detect wander, then “pivot and tilt” belt into place
- Ideal solution for cupped and high-tension belts
- Performs in wet and dry conditions
- Return-side installation only



Specifications:

Maximum Belt Tension: 525 n/mm (3000 PIW)
Belt Widths: 600-1500 mm (24-60")

Heavy Duty PT Max™ Return Side

- Ideal for high tension belts

Specifications:

Maximum Belt Tension: 1050 n/mm (6000 PIW)
Belt Dimensions: 1350-2100 mm (54"-84") wide

Super Duty PT Max™ Return Side

- For highest tension applications

Specifications:

Maximum Belt Tension: 1750 n/mm (10,000 PIW)
Belt Widths: 1800-3000 mm (72"-120")

YOUR ISSUE: LOAD-POINT SPILLAGE OUR SOLUTION: IMPACT BEDS, SLIDER BEDS, SKIRTING SYSTEMS, PLOWS & MORE

Set Up an Appropriate Transition Distance

- Often compromised to save space, but short transition can lead to premature belt, lagging, and idler wear or failure.
- Using your idlers or Flexco adjustable idlers, follow CEMA recommendations based on your trough angle, belt tension and belt carcass construction.

Divert Material to Avoid Damaging Tail Pulley or Belt

- Material trapped between the pulley and belt can cause significant damage to both.
- Use a plow before the tail pulley to remove material from the belt:
Diagonal Plow for one-side discharge
V-Plow for two-side discharge

Protect Belt in Impact Area

- Just like the belt, impact beds see every ounce of every ton of product. Careful consideration should be made to account for the worst-case impact your system may ever see.
- Find your drop height and material lump weight to select the proper bed. Never pick a bed with a lower impact rating.
- Flexco offers beds for numerous impact ratings:
Up to 25 kg-m (200 ft-lbs): EZSB-I, EZIB-L, MSB, DRX-200
25 to 100 kg-m (200 to 750 ft-lbs): EZIB-M, DRX-750
100 to 200 kg-m (750 to 1500 ft-lbs): MIB, DRX-1500
200 to 400 kg-m (1500 - 3000 ft-lbs): DRX-3000



When it comes to load zones, our impact beds deliver the highest level of material containment and belt protection. They've been specially designed to control acceleration, deaden impact energy, reduce damaging vibrations, and extend belt life.

Ultimate Performance – Flexco Transfer Chute Solutions

We have over 25 years of experience in designing and implementing superior transfer-point solutions. We offer:

- Tasman Warajay Technology™ —the original “controlled flow” solution
- Greater throughput with virtually no plugging
- Custom engineering to meet your needs
- Advanced diversion capabilities



Seal the Load Zone

- Clamps and skirting provide the final—and very important—assurance against spillage.
- Clamps should be durable yet easy to use when skirting needs adjustment or replacement.

Track Belt in Load-Point

- If belt is mistracking before the load zone it will mistrack through the load zone, causing spillage.
- Prevent mistracking by installing a Belt Positioner, PT Smart™, or PT Max™ before the tail pulley.

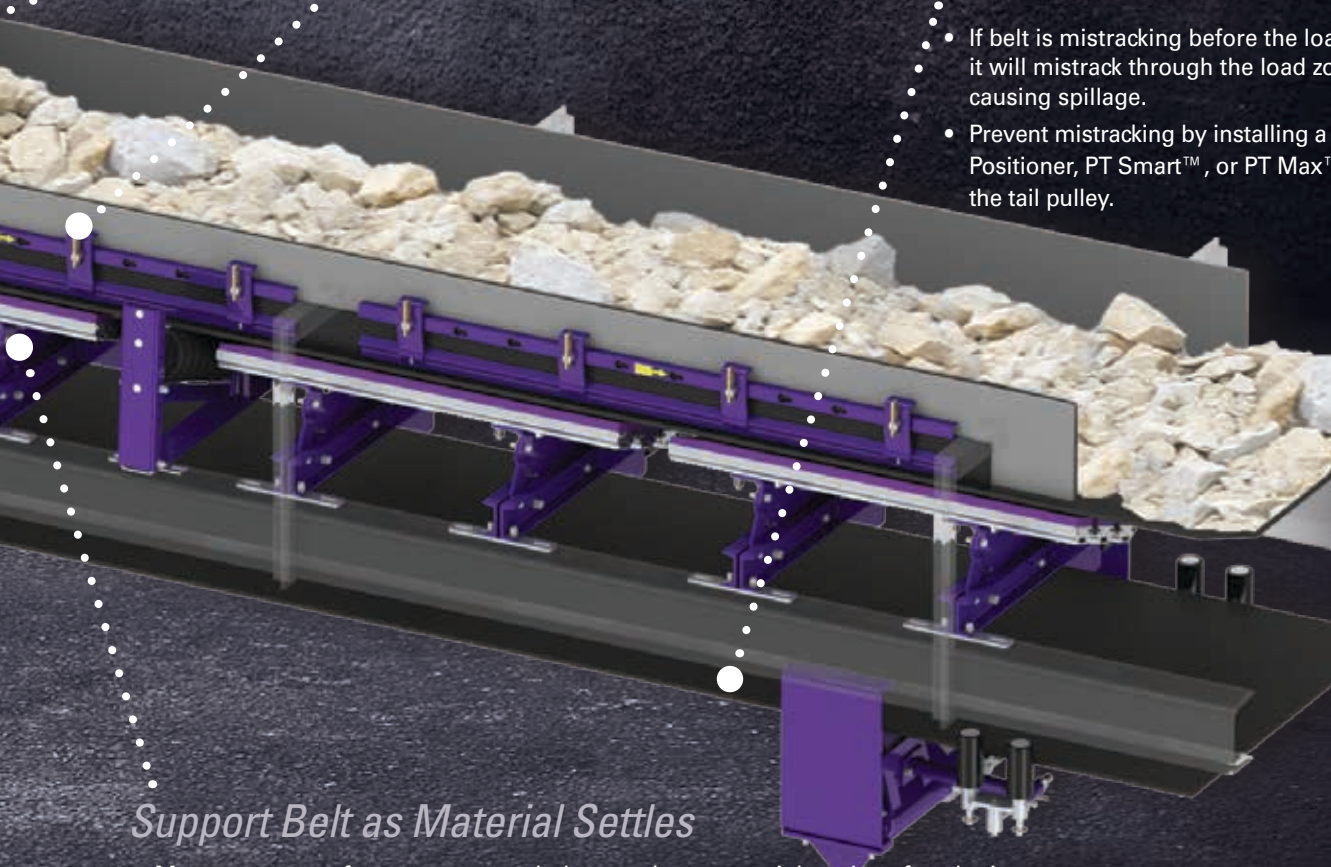

Support Belt as Material Settles

- Most conveyors feature an extended area where material settles after the impact area.
- Idlers often used but sealing with idlers is difficult due to belt sag. Impact beds can be used to help with sealing but are expensive and cause belt drag.
- EZSB-C provides the best of both: idlers in center to reduce drag, and UHMW bars on trough to provide constant sealing.

How to Select the Right Impact Bed

Step 1:

Calculate Your Impact Energy

Identify the weight of your largest lump size and multiply this number by your drop height. The result, expressed in lb/ft (kg/m), will be your estimated impact energy.

Material Reference Table

Material	kg/m ³	lb/ft ³
Coke	657	41
Fertilizer	961	60
Bauxite, crushed	1281	80
Potash	1281	80
Coal, Bituminous, Solid	1345	84
Coal, Anthracite, Solid	1505	94
Slag, Solid	2114	132
Chromium Ore	2162	135
Halite (Salt), Solid	2322	145
Phosphorus	2338	146
Stone (Common, Generic)	2515	157
Limestone, Solid	2611	163
Shale, Solid	2675	167
Granite, Solid	2691	168
Gypsum, Solid	2787	174
Trap Rock, Solid	2883	180
Dolomite, Solid	2899	181
Malachite (Copper Ore)	3860	241
Platinum Ore	4293	268
Hematite (Iron Ore)	5158	322

Step 2:

Match the Result to the Bed Rating

No Impact: EZSB-C

Up to 25 kg-m (200 ft-lbs): DRX200, MSB, EZSB-I, EZIB-L

25 to 100 kg-m (200 to 750 ft-lbs): DRX750, EZIB-M

100 to 200 kg-m (750 to 1500 ft-lbs): DRX1500, MIB

200 to 400 kg-m (1500 - 3000 ft-lbs): DRX3000

Sample Calculation

Gather data for your Impact Energy Calculation:

Q: What size material are you running?

A: I'm running 200mm (8") minus limestone.

Q: Is that the largest piece you've seen or could a larger piece get through that 200mm (8") crusher setting?

A: Yes, that's the crusher setting; the largest rock I've seen is 200 x 400 x 400mm (8"x16"x16").

Lump Weight (W)

Limestone Material Density = 2611 kg/m³ (163 lb/ft³)

Volume = $\frac{203}{1000} \times \frac{406}{1000} \times \frac{406}{1000} = 0.033 \text{ m}^3$ (8/12 x 16/12 x 16/12 = 1.185 ft³)

W = 2611 x 0.033 = 87 kg (163 x 1.185 = 193 lb)

Q: What's the fall height from the top of the feeding conveyor to the receiving belt?

A: There's a 1.5 m (5 ft) drop from the feeding conveyor to a rock box, then another 1.2 m (4 ft) drop to the receiving belt.

Drop Height (H)

H = 1.5 m + 1.2 m = 2.7 m (5 ft + 4 ft = 9 ft)

Impact Energy Calculation:

Lump Weight (W) x Drop Height (H) = Impact Energy

87 x 2.7 = 235 kg-m (193 lb x 9 ft = 1737 lb-ft)

This impact scenario would require a DRX 3000.

FLEXCO IMPACT BEDS

FEATURES & APPLICATIONS

Flexco Slider Bed (EZSB-C)

- Uses Flexco CoreTech™ idlers in center section
- Features adjustable trough frames for use on 20°, 35° or 45°
- Recommended for non-impact sealing areas
- Available with short lead time



Specifications:

Bed Rating: No impact

Maximum Belt Speed: 5.0 m/s (1000 fpm)

Applications: Sealing of extended load zone

Flexco Slider Impact Bed (EZSB-I)

- Uses Flexco CoreTech™ impact idlers in center section
- Features adjustable trough frames for use on 20°, 35° or 45°
- Recommended for -100 to -150 mm (-4" to -6") materials
- Available with short lead time



Specifications:

Bed Rating: 25 kg-m (Up to 200 lb-ft)

Maximum Belt Speed: 5.0 m/s (1000 fpm)

Applications: Sand and Gravel

Flexco Standard-Duty Impact Bed (EZIB-L)

- Features adjustable trough frames for use on 20°, 35° or 45°
- Recommended for light-impact applications
- Recommended for -100 to -150 mm (-4" to -6") materials
- Available with short lead time



Specifications:

Bed Rating: Up to 25 kg/m (200 lb/ft)
Maximum Belt Speed: 5.0 m/s (1000 fpm)
Applications: Sand and Gravel

Flexco Medium-Duty Impact Bed (EZIB-M)

- Features adjustable trough frames for use on 20°, 35° or 45°
- For medium-impact applications
- Recommended for -200 to -250 mm (-8" to -10") materials
- Available with short lead time



Specifications:

Bed Rating: 25–100 kg/m (200 to 750 lb/ft)
Maximum Belt Speed: 5.0 m/s (1000 fpm)
Applications: Hard Rock Mining, Limestone Quarrying

DRX200 Impact Bed

- Exclusive Velocity Reduction Technology™ that deadens rebound forces for reduced spillage and material degradation
- Recommended for -100 to -150 mm (-4" to -6") materials
- Slide-Out Service™ for easy maintenance



Specifications:

Bed Rating: Up to 25 kg/m (200 lb/ft)
Maximum Belt Speed: 5.0 m/s (1000 fpm)
Applications: Sand and Gravel

DRX750 Impact Bed

- Exclusive Velocity Reduction Technology™ that deadens rebound forces for reduced spillage and material degradation
- For medium-impact applications
- Recommended for -200 to -250 mm (-8" to -10") materials
- Provides a unique second level of impact relief



Specifications:

Bed Rating: 25–100 kg/m (200 to 750 lb/ft)
Maximum Belt Speed: 5.0 m/s (1000 fpm)
Applications: Hard Rock Mining, Limestone Quarrying

DRX1500 Impact Bed

- Exclusive Velocity Reduction Technology™ that deadens rebound forces for reduced spillage and material degradation
- For high-impact applications
- Recommended for -300 mm (-12") materials
- Isolation Mounts ensure a second level of impact force reduction



Specifications:

Bed Rating: 100–200 kg/m (750 to 1500 lb/ft)
Maximum Belt Speed: 5.0 m/s (1000 fpm)
Applications: Coal-Fired Power Plants, Coal Prep Plants, Load-out Facilities

DRX3000 Dynamic Impact Bed

- Exclusive Velocity Reduction Technology™ that deadens rebound forces for reduced spillage and material degradation
- For extreme-impact applications requiring the highest energy absorption
- Impact Energy Absorbers disperse an immense amount of impact energy
- Stationary skirt support bar system helps ensure a positive seal with the skirt rubber



Specifications:

Bed Rating: 200 to 400 kg/m (1500 to 3000 lb/ft)
Maximum Belt Speed: 5.0 m/s (1000 fpm)
Applications: Any operation that combines large material size and extreme height

Applications listed are intended to identify where each impact bed is commonly and most effectively utilized. Material size, lump weight and drop height should all be considered before making a final product selection. Consult Flexco to assess specific applications and recommendations.

Modular Slider Bed (MSB)

- All bars feature 25 mm (1") UHMW for long wear life
- All bars are chamfered to work with reversing belts
- Recommended for -100 to -150 mm (-4" to -6") materials
- Adjustable trough angle 20°, 35°, 45°
- Quick and easy service with slide-out trough and center section removal



Specifications:

Bed Rating: Up to 25 kg/m (200 lb/ft)

Maximum Belt Speed: 5.0 m/s (1000 fpm)

Applications: Sand and Gravel



- Seamlessly combine slider and impact beds for ultimate performance

Modular Impact Bed (MIB)

- All bars feature 25 mm (1") UHMW for long wear life
- All bars are chamfered to work with reversing belts
- Recommended for -300 mm (12") materials
- Adjustable trough angle 20°, 35°, 45°
- Sectional slide-out service allows for service alongside the conveyor
- Outer slider bar to seal the load zone



Specifications:

Bed Rating: Up to 1500 lb/ft (200 kg/m)

Maximum Belt Speed: 5.0 m/s (1000 fpm)

Applications: Hard Rock Mining, Limestone Quarrying, Load-out Facilities

Adjustable Idler Frame

- Uses Flexco CoreTech™ idlers
- For use around load zone to lift belt off beds
- Features adjustable trough frames in 5° increments
- Useful for transition area



Specifications:

Idler Rating: CoreTech roll - No impact

CoreTech Impact roll - 200 lb/ft (25 kg/m)

Applications: For use between every two Flexco beds, transitions

Applications listed are intended to identify where each impact bed is commonly and most effectively utilized. Material size, lump weight and drop height should all be considered before making a final product selection. Consult Flexco to assess specific applications and recommendations.



FLEXCO SKIRTING SYSTEMS

Specially designed to create an effective seal at load points without damaging the top cover of your belt, our skirting systems are a smart way to improve throughput.

Flex-Seal™ Skirting System

- Dynamic containment unit that fully seals the loading zone
- Sturdy, corrosion-resistant components that deliver long service life
- Easy to install and maintain

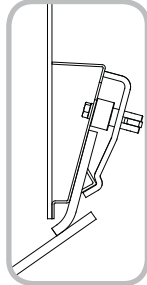

Specifications:

Module Sizes: 1200 mm (4')

Skirting Sizes: For skirt rubber 150 mm (6") wide and from 8–19 mm (5/16"–3/4") thick

Flex-Lok™ Skirt Clamps

- Heavy-duty applications
- Strong restraining bar that is held in place by clamp plates to allow easy adjustment of skirt rubber
- Anti-vibration clamp pin can be unlocked with a rubber hammer
- Easy to install and maintain
- Mini Flex-Lok™ option available—overall height of 40mm (5/2")

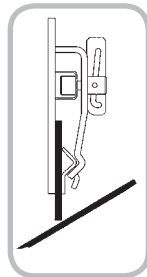

Specifications:

Module Sizes: 1800 mm (6')

Skirting Sizes: For skirt rubber from 8–25 mm (5/16"–1") thick

Polyurethane Skirting

- Polyurethane skirting offers a more wear-resistant material than typical rubber
- Lower coefficient of friction reduces strain on the system
- Works with Flexco's skirt clamp options that offer simple serviceability
- 35° chamfer eliminates the typical skirting break-in period
- Soft durometer (65A) polyurethane with exceptional tear resistance to ensure a good seal and long belt life



Specifications:

Rated for temperatures from -30°C to 82°C (-20°F to 180°F)

RMC1 Skirt Clamps

- Simple installation, no-hassle maintenance
- Versatile design that can be installed on vertical or perpendicular skirt boards
- Anti-vibration clamp pin
- Interlocking clamp plates and 1200 mm (4') clamp bar
- Limited Space (LS) option available

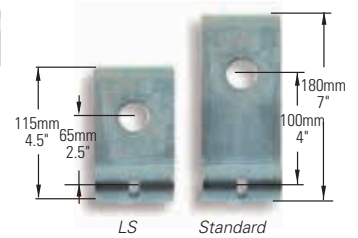

Specifications:

Module Sizes: 1200 mm (4')

Skirting Sizes: For a range of skirt rubber heights; for thicknesses from 8–19 mm (5/16"–3/4") thick

PAL Paks

- Safe, easy-to-install skirt clamps
- Clamp pins bolt or weld directly to skirt board
- Bolt-on version provides no-weld solution to eliminate sparking risks
- Limited Space (LS) option available
- Clamp plates are 180 mm/7" high (LS version 115 mm/4½" high)



Bolt-on PAL Pak



Weld-on PAL Pak

Specifications:

Skirting Sizes: For a range of skirt rubber heights; for thicknesses from 8–19 mm (5/16"–3/4") thick

TWT Skirting System

- Easy installation
- Seal skirting to your conveyor belt using vertical or tangential sealing options
- Rear door seal provides easy access for wash-down, inspection or repairs
- Dust curtains control air flow throughout the system to keep dust levels low
- Adjustable liners provide increased skirt liner life



How to Select the Right Belt Plow

When choosing a plow to prevent fugitive material from finding its way into your tail pulley, you need to consider where you want to discharge any debris.

To discharge material to a single side of the belt:

Choose the RDP1 Diagonal Plow.

To discharge material to both sides of the belt:

Choose the V-Plow.

FLEXCO PLOWS

FEATURES & APPLICATIONS

Flexco offers two advanced plows that prevent costly damage to tail pulleys and gravity take-ups, while cleaning the inside of the belt.

RDP1 Diagonal Plow

- Discharges debris to one side of belt
- Unique angled blade that creates effective "spiral" action
- Fixed position eliminates bouncing and vibration problems
- Appropriate for use at any point along inside of return belt
- Simple and quick installation and blade replacement



Specifications:

Maximum belt speed: 3.5 m/s (700 fpm)
Belt Widths: From 450–2100 mm (18"–84")

V-Plow

- Simultaneously discharges debris to both sides of belt
- Angled blade design "spirals" away debris and water
- Easy to install and maintain
- Fits virtually any conveyor structure
- Turnbuckle at nose allows for fine-tuning at installation



Specifications:

Maximum belt speed: 5 m/s (1000 fpm)
Belt Widths: From 450–2400 mm (18"–96")

Unique angled blade (on both Diagonal and V-Plow models) quickly spirals material off the belt, preventing it from working its way under the blade and providing a superior and more efficient cleaning.



YOUR ISSUE: SLIPPAGE OUR SOLUTION: PULLEY LAGGING

How to Select the Right Lagging Product

To select the right pulley lagging, be sure to consider the environmental conditions around the pulley:

- Belt condition, i.e., wet or dry
- The service required for bonded lagging versus weld-on
- The expected wear life of the lagging

Use the following chart to identify the best Flexco lagging for your needs.

Criteria	Flex-Lag® Rubber			Flex-Lag® Ceramic			Flex-Lag® Weld-On™	
	Light Duty	Plain	Diamond	Diamond Pattern	Medium Ceramic	Full Ceramic	Rubber Diamond	Full Ceramic
Total Thickness*	7.5 mm (5/16")	10–25 mm (3/8"–1")	10–25 mm (3/8"–1")	13 mm (1/2")	15 mm (5/8")	13 mm (1/2")	14 mm (9/16")	15 mm (5/8")
Belt Width*	Any Width	Any Width	Any Width	Any Width	450–2100 mm (18"–84")	450–2100 mm (18"–84")	450–1800 mm (18"–72")	450–1800 mm (18"–72")
Minimum Pulley Diameter	2" (50 mm)	300 mm (12")	300 mm (12")	300 mm (12")	300 mm (12")	300 mm (12")	400 mm (16")	400 mm (16")
Dry Friction	Very Good	Excellent	Very Good	Very Good	Excellent	Excellent	Very Good	Excellent
Wet Friction	Average	Average	Good	Very Good	Excellent	Excellent	Good	Excellent
Wet/Muddy Friction	-	Average	Average	Good	Very Good	Very Good	Average	Very Good
Wear Life	Good	Good	Good	Very Good	Excellent	Best	Good	Best
Ease of Installation	Good	Good	Good	Good	Good	Good	Best	Best
Drainage Grooves	No	Yes						
FRAS (Fire Resistant Anti-Static)	No	Available						
Rubber Compound	SBR							
Hardness (Shore A)	68 +/- 3							
Ceramic Compound	-	-	-	Al ₂ O ₃	Al ₂ O ₃	Al ₂ O ₃	-	Al ₂ O ₃
Ceramic Coverage	-	-	-	13%	39%	80%	-	74%
Operating Temperature	-15° – 85° C (5° – 185° F)							

*Additional thicknesses and widths available as special orders. For weld-on lagging, thickness includes the backing plate.

Criteria		Flex-Lag® Rubber			Flex-Lag® Ceramic			Flex-Lag® Weld-On™	
		Light Duty	Plain	Diamond	Diamond Pattern	Medium Ceramic	Full Ceramic	Rubber Diamond	Full Ceramic
Pulley Diameter	<20" (<500 mm)	OK	10 mm 3/8"	10 mm 3/8"	12 mm 1/2"	15 mm 5/8"	12 mm 1/2"	OK	OK
	20"–32" (500–800 mm)	Non-Drive Only	10 mm–12 mm 3/8"–1/2"	10 mm–12 mm 3/8"–1/2"	12 mm 1/2"	15 mm 5/8"	12 mm 1/2"	OK	OK
	32"–48" (800–1200 mm)	-	12 mm–20 mm 1/2"–3/4"	12 mm–20 mm 1/2"–3/4"	12 mm–15 mm 1/2"–5/8"	15 mm 5/8"	12 mm–15 mm 1/2"–5/8"	OK	OK
	>48" (>1200 mm)	-	15 mm–25 mm 5/8"–1"	15 mm–25 mm 5/8"–1"	15 mm–25 mm 5/8"–1"	15 mm–25 mm 5/8"–1"	15 mm–25 mm 5/8"–1"	OK	OK
Fabric Belts	Low (<500 PIW)	OK	10 mm–12 mm 3/8"–1/2"	10 mm–12 mm 3/8"–1/2"	12 mm 1/2"	15 mm 5/8"	12 mm 1/2"	OK	OK
	Medium (500–1000 PIW)	Non-Drive Only	12 mm–15 mm 1/2"–5/8"	12 mm–15 mm 1/2"–5/8"	12 mm 1/2"	15 mm 5/8"	12 mm 1/2"	OK	OK
	High (1000–2000 PIW)	-	15 mm–20 mm 5/8"–3/4"	15 mm–20 mm 5/8"–3/4"	15 mm–25 mm 5/8"–1"	15 mm–25 mm 5/8"–1"	15 mm–25 mm 5/8"–1"	-	-
Steel Cord Belts	Medium (ST500–ST3150)	-	12 mm–20 mm 1/2"–3/4"	12 mm–20 mm 1/2"–3/4"	12 mm–20 mm 1/2"–3/4"	15 mm–20 mm 5/8"–3/4"	12 mm–20 mm 1/2"–3/4"	-	-
	High (ST3500–ST5400)	-	20 mm–30 mm 3/4"–1-1/4"	20 mm–30 mm 3/4"–1-1/4"	15 mm–30 mm 5/8"–1-1/4"	15 mm–30 mm 5/8"–1-1/4"	15 mm–30 mm 5/8"–1-1/4"	-	-

Red items available as specials.

FLEXCO PULLEY LAGGING

Light-Duty Rubber Lagging

- Specially designed for pulleys with diameters as small as 50 mm (2").
- Moisture is channeled between small raised buttons that support and grip the belt and deliver superior traction.
- Available in SBR and White Nitrile

Belt Width: Any Width

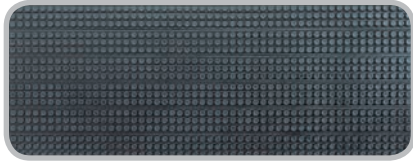

Plain-Pattern Rubber Lagging

- Helps prevent belt slippage in dry environments.
- Provides larger surface contact area relative to other patterned lagging.
- Horizontal grooves channel water and debris while providing a better dynamic interaction with the belt compared to sheet lagging.
- Available with FRAS approved rubber, marked in blue for easy identification on site.

Belt Width: Any Width



Diamond-Pattern Rubber Lagging

- Diamond pattern features a bidirectional design for superior water-shedding characteristics.
- Horizontal grooves provide a second method to disperse water and debris off the lagging and prevent hydroplaning.
- Performs well in both dry and wet applications.
- Available with FRAS approved rubber, marked in blue for easy identification on site.

Belt Width: Any Width



Diamond Pattern Ceramic Lagging

- **13% tile coverage**
- Large ceramic tile is molded into the diamond section, providing an increased coefficient of friction vs. Diamond-Pattern Rubber.
- Also features a bidirectional design for superior water-shedding characteristics.
- Uses the advantages of a ceramic product at a more affordable cost in light or medium duty applications.
- Available with FRAS approved rubber, marked in blue for easy identification on site.

Belt Width: Any Width

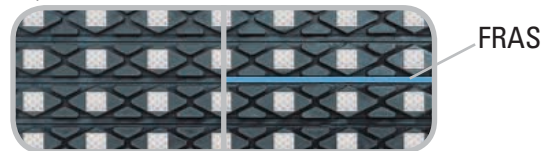

Medium Ceramic Lagging

- **39% tile coverage**
- Constructed from individual ceramic tiles molded into a high-durometer rubber for excellent abrasion resistance.
- Excellent performance in dry or wet applications and very good performance in muddy applications.
- Molded ceramic buttons grip the belt's underside for positive traction.
- Excellent friction for mid-range tension belts.
- Available with FRAS approved rubber, marked in blue for easy identification on site.

Belt Width: from 450–2100 mm (18"–84")

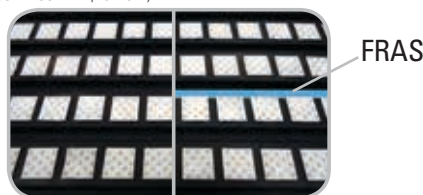

Full Ceramic Lagging

- **80% tile coverage**
- Constructed from hundreds of individual ceramic tiles molded into a durable rubber backing with a higher coverage than Medium Ceramic for best-in-class abrasion resistance.
- Most consistent performance in dry, wet or muddy applications.
- Molded ceramic buttons grip the belt's underside for positive traction.
- Best for high-tension belts.
- Available with FRAS approved rubber, marked in blue for easy identification on site.

Belt Width: from 450–2100 mm (18"–84")

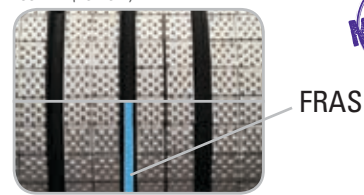

Weld-On Rubber Lagging

- Weld-On design allows for quick, in-situ installation.
- Gear-tooth layout protects cleaners on pulley from experiencing "chatter" and premature wear.
- Diamond-Pattern features a bidirectional design for superior water-shedding characteristics.
- Performs well in both dry and wet applications.
- Available with FRAS approved rubber, marked in blue for easy identification on site.

Minimum Pulley Diameter: 400 mm (16")

Belt Width: from 450–1800 mm (18"–72")



Weld-On Ceramic Lagging

- **74% tile coverage**
- Weld-On design allows for quick, in-situ installation.
- Gear-tooth layout protects cleaners on pulley from experiencing "chatter" and premature wear.
- Constructed from hundreds of individual ceramic tiles molded into a durable rubber backing.
- Most consistent performance in dry, wet or muddy applications.
- Molded ceramic buttons grip the belt's underside for positive traction.
- Available with FRAS approved rubber, marked in blue for easy identification on site.

Minimum Pulley Diameter: 400 mm (16")

Belt Width: from 450–1800 mm (18"–72")

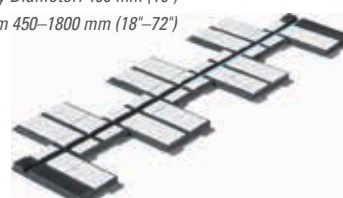

FLEXCO PULLEY LAGGING ADHESIVES

Flex-Lag® Adhesives are a two-part cold bonding system designed specifically for use with rubber-to-rubber and rubber-to-metal adhesion. Flex-Lag Adhesives are also produced without using chlorofluorocarbons (CFCs). An excellent bond is achieved while using the minimal amount of cement and primer thanks to high adhesion during installation and after curing.

Primer specifically paired with the adhesive for optimal bonding strength

Adhesive and activator mix on a 1 can : 1 bottle ratio for simplified ordering, stocking and preparation

Excellent Bonding Strength

- Simple to order, easy to use
- Environmentally friendly, free of chlorofluorocarbons (CFC)
- Works with all Flexco cold-bond lagging products



Use the following charts to determine correct order quantities for your pulley size.

Each Flex-Lag Adhesive is mixed with one Flex-Lag Activator. Refer to the usage chart below to calculate the number of cans required for your pulley. For sizes not included in the chart please contact Flexco Customer Service for assistance.

ADHESIVE 0.8L / ACTIVATOR 40g (1 can : 1 bottle mix ratio)

Pulley Diameter	Face Width																					
	mm	254	356	457	559	660	762	864	965	1067	1168	1270	1372	1473	1575	1676	1778	1880	1981	2083	2184	2286
	in.	10	14	18	22	26	30	34	38	42	46	50	54	58	62	66	70	74	78	82	86	90
203	8	1	1	1	1	1	1	1	1	2	2	2	2	2	2	2	2	2	2	3	3	3
305	12	1	1	1	1	1	2	2	2	2	2	2	3	3	3	3	3	3	3	4	4	4
406	16	1	1	1	2	2	2	2	2	3	3	3	3	3	4	4	4	4	4	5	5	5
508	20	1	1	2	2	2	2	3	3	3	3	4	4	4	4	5	5	5	5	6	6	6
610	24	1	2	2	2	2	3	3	3	4	4	4	5	5	5	6	6	6	7	7	7	7
711	28	1	2	2	2	3	3	3	4	4	5	5	6	6	6	7	7	7	8	8	8	8
813	32	2	2	2	3	3	4	4	4	5	5	6	6	7	7	8	8	8	9	9	9	10
914	36	2	2	3	3	3	4	4	5	5	6	6	7	7	8	8	8	9	9	10	10	11
1016	40	2	2	3	3	4	4	5	5	6	6	7	7	8	8	9	9	10	10	11	11	12
1118	44	2	2	3	4	4	5	5	6	6	7	7	8	9	9	10	10	11	11	12	12	13
1219	48	2	3	3	4	4	5	6	6	7	7	8	9	9	10	10	11	12	12	13	13	14
1321	52	2	3	3	4	5	5	6	7	7	8	9	9	10	11	11	12	13	13	14	15	15
1422	56	2	3	4	4	5	6	6	7	8	9	9	10	11	11	12	13	14	14	15	16	16
1524	60	2	3	4	5	5	6	7	8	8	9	10	11	11	12	13	14	14	15	16	17	17

PRIMER .75L

Pulley Diameter	Face Width																					
	mm	254	356	457	559	660	762	864	965	1067	1168	1270	1372	1473	1575	1676	1778	1880	1981	2083	2184	2286
	in.	10	14	18	22	26	30	34	38	42	46	50	54	58	62	66	70	74	78	82	86	90
203	8	1	1	1	1	1	1	1	1	1	1	1	1	1	1	1	1	1	1	1	1	1
305	12	1	1	1	1	1	1	1	1	1	1	1	1	1	1	1	1	1	1	1	1	1
406	16	1	1	1	1	1	1	1	1	1	1	1	1	1	1	1	1	1	1	1	1	1
508	20	1	1	1	1	1	1	1	1	1	1	1	1	1	1	1	1	1	1	1	1	1
610	24	1	1	1	1	1	1	1	1	1	1	1	1	1	1	1	1	1	1	1	1	1
711	28	1	1	1	1	1	1	1	1	1	1	1	1	1	1	1	1	1	1	1	1	1
813	32	1	1	1	1	1	1	1	1	1	1	1	1	1	1	1	1	1	1	1	1	1
914	36	1	1	1	1	1	1	1	1	1	1	1	1	1	1	1	1	1	1	1	1	2
1016	40	1	1	1	1	1	1	1	1	1	1	1	1	1	1	1	1	1	2	2	2	2
1118	44	1	1	1	1	1	1	1	1	1	1	1	1	1	1	1	2	2	2	2	2	2
1219	48	1	1	1	1	1	1	1	1	1	1	1	1	1	1	2	2	2	2	2	2	2
1321	52	1	1	1	1	1	1	1	1	1	1	1	1	2	2	2	2	2	2	2	2	2
1422	56	1	1	1	1	1	1	1	1	1	1	1	2	2	2	2	2	2	2	2	2	2
1524	60	1	1	1	1	1	1	1	1	1	1	2	2	2	2	2	2	2	2	2	2	2

FLEXCO SERVICES



Inspection, Installation and Maintenance

Around the world, Flexco has your operation covered. Whether it be with our factory-trained and certified Flexco resources or our trained distributor partners, we're there to ensure you maximize the return on your investment by making sure Flexco's products are properly specified, installed, or maintained.

Ensuring the product is installed correctly and maintained is critical to provide the optimal results our products are engineered to deliver. Flexco takes pride in making sure you have access to the resources that make certain the products exceed your expectations.



Conveyor Assessments

Having a third party review your conveyor system can prove to be an effective way to identify performance, maintenance and safety concerns that can be critical to minimizing downtime and maximizing your productivity.

Flexco's assessment program allows you to proactively address belt conveyor concerns before they lead to costly repairs and unscheduled downtime. Focusing on issues such as spillage, carryback, belt slippage, and mistracking, Flexco specialists will record their findings and return to your operation with a complete recommendation on the system, identifying immediate needs and suggesting future fixes.



Training

Flexco offers training programs around the world that are flexible to meet your needs and requirements. Our programs range from coming to your site to train a maintenance team to hosting you at one of our Flexco training centers at 10 locations around the world. Our comprehensive Flexco University program delivers the knowledge and skills required to ensure you keep your belts running effectively and efficiently, balancing both classroom and field instruction to deliver a detailed, thorough education program. We utilize a variety of tools, from mobile showrooms to demonstration conveyors to provide the most value.





Partners *Plus* 

TRUST YOUR PARTNERS IN PRODUCTIVITY

Flexco's *Partners Plus* distributors are strategic partners that have been certified to provide unsurpassed quality installations and service to complement the industry's leading products. Partners Plus Distributors are also certified by Flexco to diagnose problems, recommend solutions, and share advanced knowledge that will help operations maintain their belt conveyor systems and maximize efficiency and output.

Fewer than 5% of all Flexco distributors are Authorized Partners Plus distributors, making this a special distinction given to distributors who have committed to providing the skills required to earn this title. To obtain this certification, employees from our distributor partners undergo extensive training, learning to properly specify, install, maintain, and troubleshoot Flexco products. Continual training is offered throughout the year to ensure they are fully up to speed on Flexco's offerings and latest innovations. Each partner is recertified each year they are in the program.

Our Partners Plus distributors are easily identified by looking for this logo  on our website's distributor locator. With over 30 partners in over 15 countries, this growing program that partners Flexco with local experts and the operations in their regions allows us to work together to address their productivity needs.

We work with you to determine the best solution.

Partners Plus distributors are trained to be experts on specifying, installing, and troubleshooting Flexco products, to ensure you receive the optimal performance from your investment.

We have extensive industry knowledge.

Our hands-on industry experience gives us deep insights into your productivity demands, maintenance challenges, safety requirements, and more. We serve operations all over the world in the coal, aggregate, bulk material, and mining industries. Our global presence balanced with the expertise of our local Partners Plus distributors allows us to enhance the service you receive, actively working toward addressing your specific concerns and needs that may be unique to your operation or industry.

We're committed to safety and quality.

At Flexco, we won't settle for anything less than the best, most durable products around, and we aim to have the services and support to match. That is why we developed the Partners Plus program—to deliver a quality and consistent service program capable of matching the quality of our products.

Just as our products are designed with safety in mind, our training with our Partners Plus distributors always makes safety a top priority.

We offer a wide range of compatible products.

In addition to high-quality belt conveyor products, through our Partners Plus program we also deliver high quality support and service that matches those products.

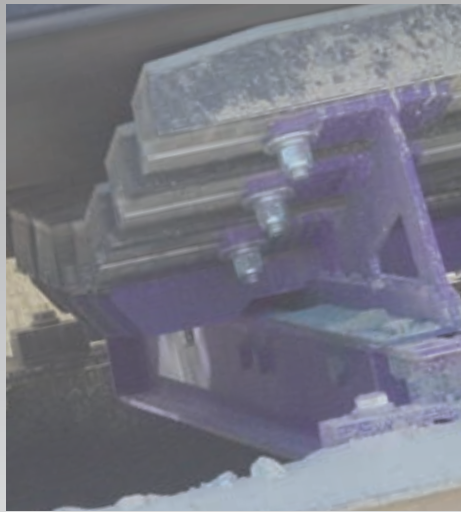
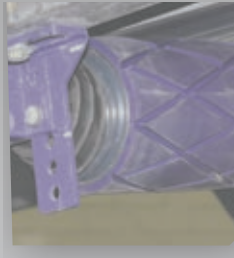

Visit our website or contact your local distributor to learn more.



Unit 7 Kingsmark Freeway • Oakenshaw • Bradford, BD12 7HW • United Kingdom
Tel: +44-1274-600-942 • Fax: +44-1274-673-644 • Email: sales@flexco.co.uk

Visit www.flexco.com for other Flexco locations and products.

©2019 Flexible Steel Lacing Company. 04/04/19. For reorder: X5860



Partners in Productivity