



Your partner in

***CEMENT  
MANUFACTURING***

**FLEXCO**

# FLEXCO IS CONVEYING CONTROL IN CEMENT



## MEET FLEXCO

For over 110 years, Flexco has focused on creating belt conveyor solutions that meet ever-changing customer needs. Flexco is committed to applying our superior knowledge and equipment to make your belt conveyor operation in the cement industry as productive as possible. Today, we help cement customers achieve the most efficient operations by providing products and services to minimize downtime and keep belt conveyor lines running smoothly.

Flexco understands the cement industry and that sets us apart. We know that belt conveyor performance is key to your operation. Our personal approach ensures that your facilities get innovative solutions perfectly suited to your needs. In addition, the people responsible for belt uptime will receive the training and assistance that enables them to take maintenance into their own hands, and to a whole new level.

We are genuinely invested in the success of the cement industry, and we'll work side-by-side with you to address any obstacles that stand in the way of optimal belt conveyor performance. Our world-class customer support system focuses on your needs first in order to help you achieve your production goals. This approach ensures that we deliver what we promise – and you get what you need.

## TRENDS IN THE CEMENT INDUSTRY



**4.5% ANNUALLY**

### GLOBAL CEMENT

Research predicts the demand for cement worldwide will rise 4.5% per year to 5.2 billion metric tons in 2019.

**60%**  
in 2030



### URBANIZATION

As the world's urban population grows from 54.5% in 2016 to 60% in 2030, infrastructure spending and construction activity will increase the demand for cement.



## GLOBAL REACH

Flexco has representation in over 150 countries, with local inventory and personnel dedicated to assisting cement manufacturers wherever you may be. We realize cement manufacturing supports many of the fastest growing industries in world. To serve increasing demand we have feet on the ground in strategic locations where we can help the most.

Along with global representatives and Partners Plus distributors, **Flexco University** brings on-site, online, and in class training to cement operations throughout the world. It is all part of our commitment to be your most valuable partner on the job, wherever that job is being done.

## A PARTNER IN THE CEMENT INDUSTRY

Over the years, we've cultivated deep relationships with key partners in the cement industry, gaining industry expertise and earning a reputation as a trusted partner in belt conveyor productivity. We've spent countless hours working alongside cement customers to understand the nuances of your everyday challenges, and we've used our hard-won knowledge to design a comprehensive lineup of belt conveyor products to address your pain points at every step of the cement manufacturing process.

To serve an industry that plays a critical support role in global development, the drive toward innovation has to be our focus. By constantly searching for new ways to make belt conveying in the cement manufacturing process more efficient, we aim to partner with you to enter into a new era of productivity.

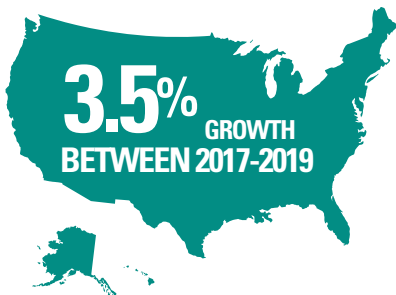

### GROWTH IN THE UNITED STATES

Demand for cement in the United States is expected to grow 3.5% between 2017 and 2019, and is **expected to grow 5% by 2020.**

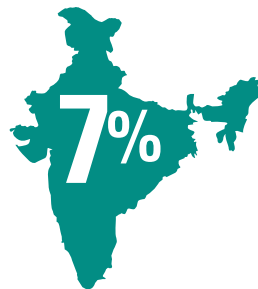

### EMERGING MARKETS IN INDIA

India accounts for 7% of the global production of cement, and the country's **demand for cement is expected to double by 2025.**

# BELT CONVEYOR SOLUTIONS YOU CAN COUNT ON

## IMPACT SOLUTIONS



**THE PROBLEM:** The impact of raw material in loading zones punctures and damages belts. Material then falls through punctured belts, which leads to loss of product and other damage to equipment along the beltline and forces manufacturers to change belts prematurely.



### THE SOLUTION



#### DRX™ IMPACT BEDS

Install the **DRX™ Impact Bed** in extreme-impact areas under the primary crushers and limestone stockpiles, where belts see the highest tonnage. A DRX Impact Bed will support belts that carry materials measuring up to 12 inches.



#### FLEXCO IMPACT BEDS

For areas where materials have been crushed to one inch or less, specifically during the processes following the secondary crusher, there is the **Flexco Impact Bed**. Its function is to support the belt and seal the load zone in order to eliminate dust.



#### FLEXCO SLIDER BEDS WITH IMPACT IDLERS

**Flexco Slider Beds with Impact Idlers and Adjustable Idler Sets with Impact Rolls** should be placed throughout the process in areas where low impact affects productivity such as in raw materials storage and proportioning and after pyroprocessing. Flexco Slider Beds will support belts carrying materials that measure under 3" (75 mm).

## PULLEY LAGGING



**THE PROBLEM:** Pulleys with worn or no lagging result in slippage that causes misalignment and leads to excess wear on pulleys and system components. Additionally, traditional slide lag can cause belt and cleaner chatter producing fugitive dust that settles and hardens causing additional damage to components and structure.



### THE SOLUTION



#### FLEX-LAG® WELD-ON™

For use throughout the plant, the patented **Flex-Lag® Weld-On™** can be quickly and easily installed with the pulley in place, or better yet, prior to pulley installation. The gear-tooth design protects belts from premature wear and chatter from belt cleaner interaction.

## SKIRTING SYSTEMS

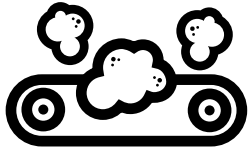

**THE PROBLEM:** Cement dust is so fine that it can pass through a sieve that can hold water. This fugitive dust builds up and hardens in areas around finish mills and clinker storage, wreaking havoc on conveyor systems. Additionally, product spillage throughout the process results in costly product loss and requires hundreds of man-hours for clean-up.



### THE SOLUTION



#### FLEX-SEAL™ SKIRTING

Put **Flex-Seal™ Skirting** in areas throughout the process where the load zone needs to be fully sealed. It is especially effective in the transfers between the primary crusher and the stockpile, as well as in the secondary crusher, where confined spaces make cleanup challenging, if not impossible. Flex-Seal is also ideal on belts carrying clinker to storage or finish mills where dust needs to be contained.



#### URETHANE SKIRTING

**Urethane Skirting** should be installed around high-abrasion applications in areas such as clinker storage and near the finish mills, where rough clinker causes extra wear. Flexco long-wearing urethane skirting lasts three-to-four times longer than traditional rubber skirting.



#### ENCLOSED SKIRT SYSTEM

Where full containment is required, including the finish mill, use the Flexco custom **Enclosed Skirt System**. It is highly effective in areas where fugitive clinker dust creates issues as it settles on equipment.

## TRANSFER CHUTES



**THE PROBLEM:** Dust control at transfer points is critical for cement operations. As transferred materials move through the chute, they become agitated and dust levels elevate. Additionally, those materials adhere to chute side walls causing buildup, and at times, the chute can plug completely. Air cannons are commonly used to shake loose the buildup, but they generate additional dust and can take up valuable man-hours for maintenance and repair.



### THE SOLUTION

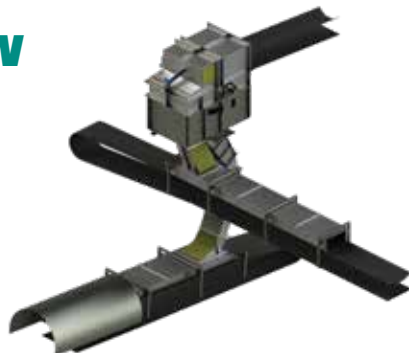

#### FLOWFIRST™ TRANSFER CHUTES

Installing a **FlowFirst™ Transfer Chute** controls the flow of materials to eliminate agitation and minimize dust levels. In addition, FlowFirst chute liners stand up to abrasive materials and eliminate the buildup without relying on installation of multiple air cannons.

## BELT TRACKERS

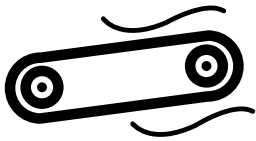

**THE PROBLEM:** The daily abuse that conveyor systems take hampers tracking and alignment. Challenges with old structures, worn idlers, buildup, and belts with frayed edges all add up, and simple adjustments of the tail pulley can't be relied on for proper tracking.



### THE SOLUTION



#### **PTEZ™ BELT TRAINERS**

Ideal for use in areas where there is buildup on structures and components or where belts have worn or damaged edges. The PTEZ™ is designed with few exposed components so buildup is minimized and uses a patented "pivot and tilt" feature to immediately compensate for belt misalignment without the use of sensor or edge rollers.

#### **PT™ MAX AND PT™ SMART BELT TRAINERS**

PT™ Max Belt Trainer and PT™ Smart Belt Trainer can be employed between quarries and stockpiles where belts are wider, loads are heavier, and materials may travel a considerable distance.

## MECHANICAL BELT FASTENERS



**THE PROBLEM:** Downtime can cost a cement plant as much as \$25,000 an hour, so operators need to replace belts and get damaged belts up and running as quickly as possible. Many cement plants also have vulcanized belts, where splices often require timely outside maintenance.



### THE SOLUTION



#### **FLEXCO® BOLT SOLID PLATE SYSTEM**

From the secondary crusher to the finish mill, the Flexco® Bolt Solid Plate System is a strong sift-free conveyor splicing system that meets the demands of the cement industry's most highly abrasive and corrosive applications.



#### **ALLIGATOR® STAPLE SYSTEM**

Ideal for use on thinner belts in pack houses, the Alligator® Staple splice features beveled edges to reduce the likelihood of ripping open bags prior to shipping.

### MECHANICAL FASTENING SYSTEMS

Whether they are used as a quick repair or as a permanent connection, mechanical splices allow for easy maintenance and are a viable option for most cement applications. Selecting the right splice and proper installation for each application is important. For in-depth help with selection and maintenance, Flexco has developed multiple options for training your crew.



# BELT CLEANERS



**THE PROBLEM:** Carryback and buildup of debris on belts causes wear and tear, poor tracking, and seized idlers. Fortunately, Flexco offers belt cleaning solutions to combat the dry, wet, dusty, sticky, and hot materials present throughout the cement manufacturing process.



## THE SOLUTION



### **MMP PRECLEANER AND MHS SECONDARY CLEANER**

In the quarry, and at the primary crusher and stockpiles, where wider belts travel at faster speeds, install the **MMP Precleaner & MHS Secondary Cleaner**. The robust designs of these cleaners can withstand the toughest abuse caused by larger materials found earlier in the process.



### **U-TYPE® SECONDARY CLEANER**

The **U-Type® Secondary Cleaner** should be installed in areas where materials are wet and sticky, including where stockpiles are exposed to the elements as well as at cement operations with clay slip processing.



### **EZP1 PRECLEANER AND Y-TYPE™ SECONDARY CLEANER**

The **EZP1 Precleaner** and **Y-Type™ Secondary Cleaner** should be installed throughout the process, especially in areas such as the materials storage and proportioning and finish mills, where dust is widespread. These cleaners facilitate the capture of usable material in order to maximize profits and avoid potential MSHA citations for hazardous piles.



### **HIGH TEMP EZP1 PRECLEANER AND HIGH TEMP HV PRECLEANER**

Ideal for use on belts that carry clinker, the **High Temp EZP1 Precleaner** for mechanically fastened belts and the **High Temp HV Precleaner** for vulcanized belts hold up to abrasive clinker and high heat.



### **V-PLOW**

In many areas around the plant, such as the limestone and other materials crushers, as well as raw material storage and portioning, the material moving through the tail pulley damages both the pulley and the belt. To avoid these problems, the low maintenance Flexco **V-Plow** discharges materials, protecting the tail pulley and the belt.

# BELT MAINTENANCE



**THE PROBLEM:** Maintaining belt conveyor systems is the key to efficiency, but many operators don't have an excess amount of time to spend on maintenance. They need easy-to-use belt maintenance tools that reduce repair time while ensuring worker safety.



## THE SOLUTION



### **FLEX-LIFTER™ BELT LIFTER**

Quickly and safely lift belts out of the way in order to perform belt maintenance. This portable tool lets you efficiently set up a splicing station or replace worn idlers.



### **FAR-PUL™ HD® BELT CLAMPS**

Patented heavy-duty clamps are specially designed to properly secure a belt for safe conveyor maintenance and splice installation or repair.



### **FLEXCO BELT CUTTERS**

Squared and cleanly cut belts are essential to long-lasting splices and belts that track on center. Flexco belt cutters are available in multiple sizes to accommodate various belt sizes



### **FSK™ BELT SKIVER**

Create lower profile splices that are less susceptible to wear and tear. The **FSK™ Belt Skiver** has a simple, manual operation that precisely removes top covers in a single pass.



### **INSPECTION DOORS**

These easy-to-install doors allow for inspections of enclosed structures while providing a dust-tight seal. They feature an adjustable latch and are rated to hold up in extreme temperatures.





**FLEXCO**

**Global Support  
Wherever You  
Need It, Whenever  
You Need It.**

### **FLEXCO DIRECT SUPPORT**

Flexco has 13 locations strategically positioned around the world. Our team of sales, engineering, and service personnel is dedicated to supporting your cement operation.

### **PARTNERS PLUS CERTIFIED DISTRIBUTORS**

Flexco distributors are present in over 150 countries. Many of these distributors have Partners Plus certification, having undergone specialized Flexco training in order to diagnose problems, recommend solutions, and share advanced knowledge to better maintain your belt conveyor over the long haul.

Flexco created the **Partners Plus Program** so distributors can provide expert-level knowledge about Flexco products, consultative support that can improve your productivity, and rapid response to service requests. Partners Plus distributors can perform line audits, offer belt conveyor troubleshooting and provide advanced notice about Flexco product introductions specific to the cement industry. It's much like having a Flexco field representative on site.

Many are also qualified to provide Flexco University training. With locations and local inventory around the globe, Flexco Partners Plus certified distributors ensure that cement manufacturers get whatever products and support you need, when you need it.

**YOUR PARTNER IN CEMENT**



# CONVEYING EDUCATION



## FLEXCO UNIVERSITY

To help our clients achieve optimal belt conveyor productivity, we go beyond simply supplying the right products. We provide extensive support and training on how to use them. Through **Flexco University**, your team will have access to online, on site, and in class learning opportunities that will help them become on-site experts for your belt conveyors. These learning opportunities can be combined and customized to meet the needs of individual cement operations.

## FLEXCO UNIVERSITY ONLINE

Flexco University Online provides professional training on mechanical belt fastening, belt conveyor products, belt maintenance, and transfer point solutions. **Courses are available at [www.flexcouniversity.com](http://www.flexcouniversity.com)** and can be accessed at any time it is convenient, day or night. Three levels of courses are available through this program, with each course lasting between 30 and 60 minutes.

- **100 Level Courses** introduce the basics of our products while addressing common issues that affect system productivity.
- **200 Level Courses** provide an in-depth review of Flexco products, their industry applications, safety features, basic installation and operation instructions.
- **300 Level Courses** cover subjects such as specialty splicing and troubleshooting.

Individuals can take courses at their own pace and can choose to take all courses or only the most relevant ones. Course completion certificates are available to help document site specific training requirements. Additionally, cement operations can choose to manage their own online Flexco University training groups by assigning different courses, monitoring participant progress, and more.



## TRENDS IN THE CEMENT INDUSTRY

### A LOCAL PRESENCE

Because transporting cement over long distances is costly, **cement plants have been built in strategic locations around the globe** in order to get product to customers at the lowest possible cost.



### SHIFTING PRODUCTION PRACTICES IN CHINA

China's cement industry is shifting from a higher number of small cement plants to a fewer number of large cement plants. **As of 2014, the top 10 cement producers in the country held a 52% market share.**



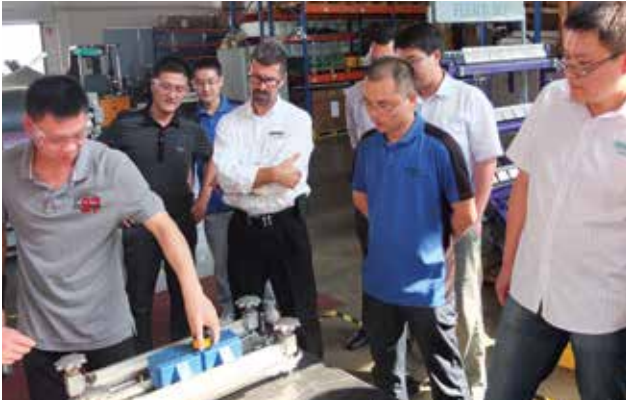

## **FLEXCO UNIVERSITY ON-SITE AND IN CLASS TRAINING PROGRAMS**

Combine online learning with on-site and in class programs to achieve the optimum training solution for your employees. Blending different methods of training, resources, and settings allows your employees to be successful in the manner where they learn best. And that's smart for your operation.



Flexco representatives and Partners Plus distributors are available to come to your location for on-site training and education. Training programs can be customized based on schedules and employee knowledge, from multi-day training for new teams to hour-long lunch and learns when training is essential but spare time is limited.

For a focused learning experience, Flexco offers in class education at training facilities around the globe. Flexco provides comprehensive multi-day sessions that include technical training, application insights, and problem solving techniques lead by experienced Flexco personnel. With a unique format that combines classroom-style lectures with hands-on installation and troubleshooting, your team benefits from networking with other learners and sharing experiences. And dedicated time out of the work environment means your employees can focus on learning without distractions in order to bring best practices for maximizing belt conveyors back to your cement operation.



### **ROOM FOR GROWTH**

Global capacity utilization rates are currently around 70%.

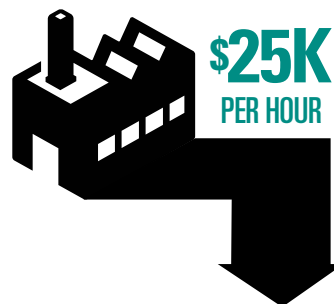

### **UPTIME**

Uptime is critical during every step of the cement manufacturing process, as **downtime** can cost as much as **\$25,000 per hour**.

**Contact your local Flexco representative  
or distributor. To find a representative or  
distributor in your area, visit [Flexco.com](http://Flexco.com)**



---

*Partners in Productivity*

2525 Wisconsin Avenue • Downers Grove, IL 60515-4200 • USA  
Tel: (630) 971-0150 • Fax: (630) 971-1180 • E-mail: [info@flexco.com](mailto:info@flexco.com)